

DDSU666-H Smart Power Sensor

User Manual

Issue 03
Date 2021-10-10



HUAWEI TECHNOLOGIES CO., LTD.



Copyright © Huawei Technologies Co., Ltd. 2021. All rights reserved.

No part of this document may be reproduced or transmitted in any form or by any means without prior written consent of Huawei Technologies Co., Ltd.

Trademarks and Permissions



HUAWEI and other Huawei trademarks are trademarks of Huawei Technologies Co., Ltd.

All other trademarks and trade names mentioned in this document are the property of their respective holders.

Notice

The purchased products, services and features are stipulated by the contract made between Huawei and the customer. All or part of the products, services and features described in this document may not be within the purchase scope or the usage scope. Unless otherwise specified in the contract, all statements, information, and recommendations in this document are provided "AS IS" without warranties, guarantees or representations of any kind, either express or implied.

The information in this document is subject to change without notice. Every effort has been made in the preparation of this document to ensure accuracy of the contents, but all statements, information, and recommendations in this document do not constitute a warranty of any kind, express or implied.

Huawei Technologies Co., Ltd.

Address: Huawei Industrial Base
Bantian, Longgang
Shenzhen 518129
People's Republic of China

Website: <https://e.huawei.com>

About This Document

Purpose

This document describes the DDSU666-H Smart Power Sensor in terms of its functions, electrical properties, and structure.

Figures provided in this document are for reference only.



Intended Audience



This document is intended for:

- Sales engineers
- Technical support engineers
- Maintenance engineers

Symbol Conventions

The symbols that may be found in this document are defined as follows.

Symbol	Description
 DANGER	Indicates a hazard with a high level of risk which, if not avoided, will result in death or serious injury.
 WARNING	Indicates a hazard with a medium level of risk which, if not avoided, could result in death or serious injury.
 CAUTION	Indicates a hazard with a low level of risk which, if not avoided, could result in minor or moderate injury.

Symbol	Description
	Indicates a potentially hazardous situation which, if not avoided, could result in equipment damage, data loss, performance deterioration, or unanticipated results. NOTICE is used to address practices not related to personal injury.
	Supplements the important information in the main text. NOTE is used to address information not related to personal injury, equipment damage, and environment deterioration.

Change History

Changes between document issues are cumulative. The latest document issue contains all updates made in previous issues.

Issue 03 (2021-10-10)

- Updated [2.3 Application Scenarios](#).
- Updated [2.7 Installing the DDSU666-H Cable](#).

Issue 02 (2021-03-01)

- Updated [2.6 Installing the DDSU666-H](#).
- Updated [2.7 Installing the DDSU666-H Cable](#).

Issue 01 (2018-03-01)

This issue is the first official release.

Contents

About This Document.....	ii
1 Safety Precautions.....	1
2 Overview.....	4
2.1 Product Overview.....	4
2.2 Working Principles.....	5
2.3 Application Scenarios.....	8
2.4 Model Naming Conventions.....	9
2.5 Product Structure.....	9
2.6 Installing the DDSU666-H.....	10
2.7 Installing the DDSU666-H Cable.....	10
3 System Maintenance.....	13
3.1 Troubleshooting.....	13
4 Technical Specifications.....	15
4.1 Environmental Specifications.....	15
4.2 Main technical performance and parameter.....	15
4.2.1 Electrical parameter.....	15
4.2.2 Percentage error.....	16
4.2.3 Start.....	16
4.2.4 Defluction.....	16
4.2.5 Other technical parameters.....	17
4.3 EMC Specifications.....	17
4.4 Structure Specifications.....	17
4.4.1 Structure specifications.....	17
5 Acronyms and Abbreviations B.....	18



1 Safety Precautions

General Safety

- Follow the precautions and special safety instructions provided by Huawei when operating this product. Personnel who plan to install or maintain Huawei devices must receive a thorough training, understand all necessary safety precautions, and be able to correctly perform all operations. Huawei will not be liable for any consequences that are caused by the violation of general safety regulations and device usage safety standards.
- Before performing operations, read through this manual and follow all the precautions to prevent accidents. The "DANGER", "WARNING", "CAUTION", and "NOTICE" statements in this document do not represent all the safety instructions. They are only supplements to the safety instructions.
- Operation personnel should comply with local laws and regulations. The safety instructions in this document are only supplements to local laws and regulations.
- Do not operate the product or handle cables during thunderstorms.
- Before operating the product, remove any conductors such as jewelry or watches.
- Use insulated tools during operations.
- Bolts should be tightened with a torque wrench and marked using red or blue color. Installation personnel should mark tightened bolts in blue. Quality inspection personnel should confirm if the bolts are tightened and then mark them in red. If screws or bolts used to secure the device are not tightened to the required torque, the device may fall from the mounting bracket.
- Follow specified procedures during installation and maintenance. Do not attempt to alter the device or deviate from the recommended installation procedures without prior consent from the manufacturer.
- Install the product in strict accordance with the quick guide.

Disclaimer

Huawei shall not be liable for any consequence caused by any of the following events:

- Transportation damage

- The storage conditions do not meet the requirements specified in this document.
- Incorrect installation or use
- Installation or use by unqualified personnel
- Failure to obey the operation instructions and safety precautions in this document
- Operation in extreme environments which are not covered in this document
- The DDSU666-H operates beyond specified ranges.
- Unauthorized modifications to the product or software code or removal of the product
- Device damage due to force majeure (such as lightning, fire, and storm)
- The warranty expires and the warranty service is not extended
- Installation or use in environments which are not specified in related international standards

Personnel Requirements

Only certified electricians are allowed to install, connect cables for, maintain, troubleshoot, and replace the DDSU666-H.

- Operation personnel should receive professional training.
- Operation personnel should read through this document and follow all the precautions.
- Operation personnel should be familiar with the safety specifications about the electrical system.
- Operation personnel should understand the composition and working principles of the grid-tied PV power system and local regulations.
- Operation personnel must wear proper personal protective equipment (PPE).

Protect Labels

- Do not scrawl or damage any warning labels on the DDSU666-H because these labels contain important information about safe operation.
- Do not scrawl or damage the nameplate on the back of the DDSU666-H because it contains important product information.

Installation

- Ensure that the DDSU666-H is not connected to a power supply or powered on before finishing installation.
- To allow proper heat dissipation and installation, maintain appropriate clearances between the DDSU666-H and other objects.

Electrical Connections

 DANGER

Before connecting cables, ensure that the DDSU666-H is not damaged in any way. Otherwise, electric shocks or fire may occur.

- Ensure that all electrical connections comply with local electrical standards.
- Ensure that the cables used in a grid-tied PV system are properly connected and insulated and meet all specification requirements.

Operation

 **DANGER**

High voltage may cause an electric shock, which results in serious injury, death, or serious property damage from the DDSU666-H in operation. Strictly comply with the safety precautions in this document and associated documents when operating the DDSU666-H.

-
- Do not touch an energized DDSU666-H because it has a high temperature.
 - Follow local laws and regulations when operating the device.

Maintenance and Replacement

 **DANGER**

High voltage may cause an electric shock, which results in serious injury, death, or serious property damage from the DDSU666-H in operation. Therefore, before maintenance, power off the DDSU666-H and strictly comply with the safety precautions in this document and associated documents to operate the DDSU666-H.

-
- Maintain the DDSU666-H with sufficient knowledge of this document and proper tools and testing devices.
 - Temporary warning signs or fences must be placed to prevent unauthorized people from entering the site.
 - The DDSU666-H can be powered on only after all faults are rectified. Failing to do so may escalate faults or damage the device.
 - During the maintenance, observe ESD precautions and wear ESD gloves.

2 Overview

2.1 Product Overview

Type DDSU666-H Smart Power Sensor (hereinafter referred to as the " Sensor ") is specially designed for the distributed photovoltaic system, to be a new Smart power sensor, combined with measurement and communication, mainly applied into the measurement for electrical quantity including voltage, current, power ,frequency, power factor, active energy etc. in the electrical circuit. It can realize networking with the external device through RS485 communication interface. Adopting the standard DIN35mm din rail mounting, structural module design, it is characterized with small volume, easy installation and networking, etc.

This performance index of the meter conforms to the following relevant technical standard:

- EN 61326-1:2013
- IEC 61326-1:2012
- EN 61326-2-1:2013
- IEC 61326-2-1:2012
- EN 61010-1:2010
- IEC 61010-1:2010
- EN 61010-2-1:2010
- IEC 61010-2-1:2010

Figure 2-1 DDSU666-H

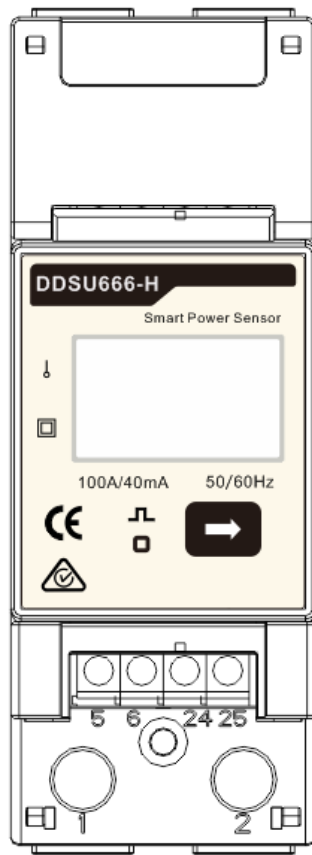

2.2 Working Principles

Conceptual Diagram

The Sensor can convert the voltage and current signal to be the signal that can be identified by MCU through the sampling circuit, MCU will calculate and convert it into energy, power, power factor and other electrical quantity by calculating the signals in the sampling circuit, transferring to users through communication and meanwhile save the data in the storage circuit. Please see the conceptual diagram of the Sensor as figure 2-2:

Figure 2-2 2-2Conceptual diagram

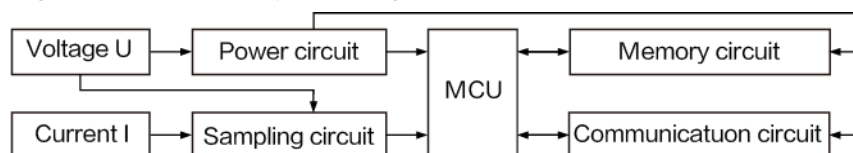

Functions

- Metering function:

Accurately metering the positive/ reverse active energy and combined active energy, no storage data loss for the sensor after power interruption.

- Measurement function of electrical parameters

The sensor can accurately measure electrical parameters including power, voltage, current, frequency, power factor, etc.

- Display function

The instrument adopts field LCD design, characterized with display function for electrical parameters and energy data. Please see LCD display in figure 2-3.

The display bit of energy measurement value can be six bits, with display range from 0 to 999999 kWh.

Figure 2-3 2-3Liquid crystal display



- Cyclic display

Characterized with cyclic display function, the shift time of cyclic display is 5 s. Please see the cyclic displayed item in table 2-1.









a. Cyclic displayed items

No.	Content	Description
1	Imp. kWh 000 120	Current positive active energy Imp = 1.20 kWh
2	Exp. kWh 000 100	Current reverse active energy Exp = 1.00 kWh
3	P kW P 1.100	Active power P=1.100 kW
4	U V U 220.0	Voltage U U=220.0 V
5	I A I 5000	Current I=5.000 A
6	F Hz F 50.00	Frequency F=50.00 Hz

- Button display

The instrument has button display and backlight function, please see button displayed items in table2-2.

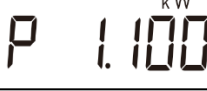
a. 2-2Button displayed items

No.	Content	Description
1		Current combined active energy =0.20 kWh
2		Current positive active energy Imp = 1.20 kWh
3		Current reverse active energy Exp = 1.00 kWh
4		n.1. data format to be eight bits,none parity bit and one stop bit. 9600: baud rate to be 9600 bps 4800: baud rate to be 4800 bps
5		Comm.Add=11
6		Voltage U=220.0 V
7		Current I=5.000 A
8		Active power P=1.100 kW
9		Power factor Ft=1.000
10		Frequency F=50.00 Hz

Note: Backlight closed without button operation for sixty seconds.

Note: The combined active energy default by the factory is equal to positive active energy.

- Parameter setting function

The sensor can set the communication address and baud rate through buttons.

Setting method please see figure 2-4: Long press the button 3s, the sensor will automatically enter into the communication address setting interface,

with cyclic display for setting display interface of baud rate and communication address. Please press the button when required for baud rate or communication address settings, it will exit to communication address and baud rate settings without button operation for twenty seconds.

The details are as follows:

Figure 2-4 Communication address and baud rate setting diagrammatic sketch

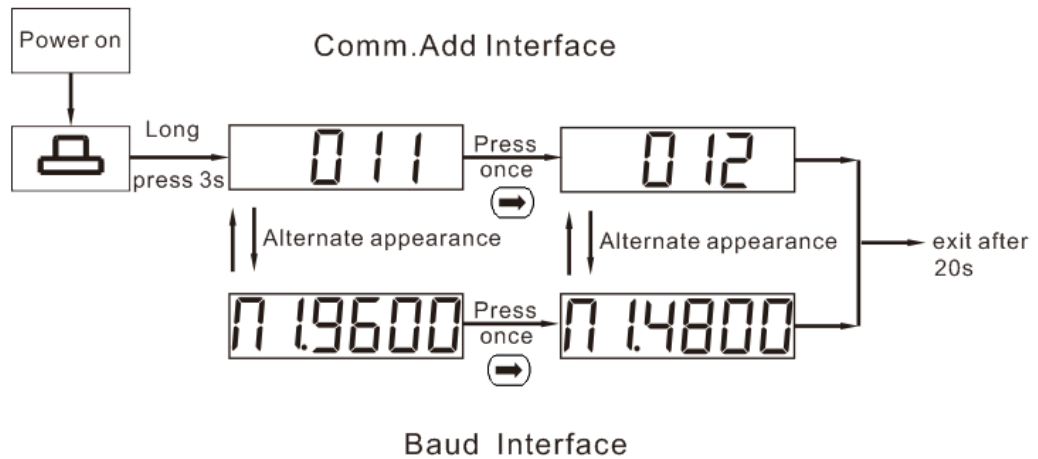

- Communication function

The sensor is equipped with one RS485 communication interface, with baud rate changed among 4800bps and 9600bps. The default baud rate is 9600bps with check bit and stop bit to be n.1, communication address (see factory number or LCD display), support ModBus—RTU protocol.

2.3 Application Scenarios

Scenario 1: The sensor is used to realize power restriction of the power grid with charge and discharge control towards energy storage in the household inverter scheme, which is the core component for household energy management. It adopts RS485 communication, which can realize the electrical quantity measurement, energy metering function and in respond to the upper host for the real-time data query.

NOTE

The smart power sensor is mainly used for power control at the grid-connection point. The measured energy yield and electricity consumption are for reference only and cannot be used as a basis for calculating electricity fees. Electricity fee measurement is subject to the meter provided by the grid company.

Figure 2-5 Application Scenario

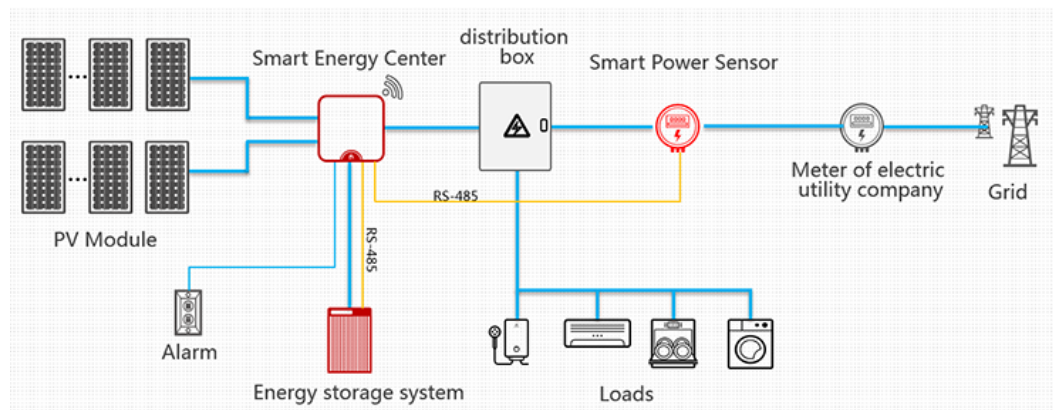

2.4 Model Naming Conventions

Figure 2-6 Model naming conventions

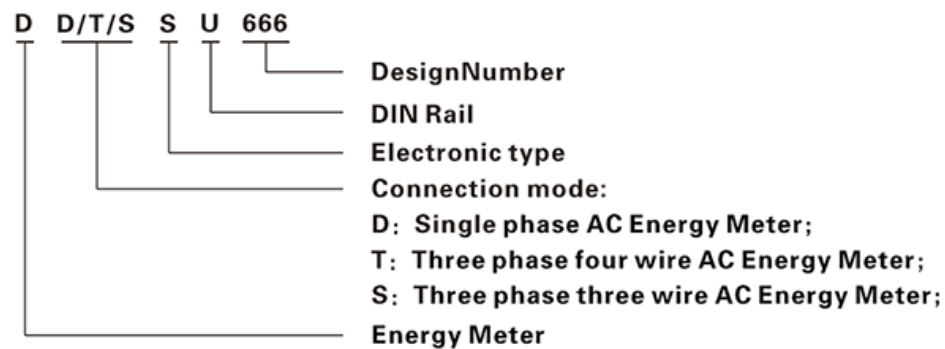

1. Model Specification

Model No.	Accuracy grade	Referenced voltage	Current specification	Collector constant	Type
DDSU666-H	Active Class 1	230 V	100 A/40 mA	800 imp/kWh	Via transformer

2.5 Product Structure

Outline dimension: 36mmx98mmx66mm; Din-rail mounting dimension: 35 mm, for the outline and installation dimension, please see Figure 2-7 as below:

Figure 2-7 Product dimensions

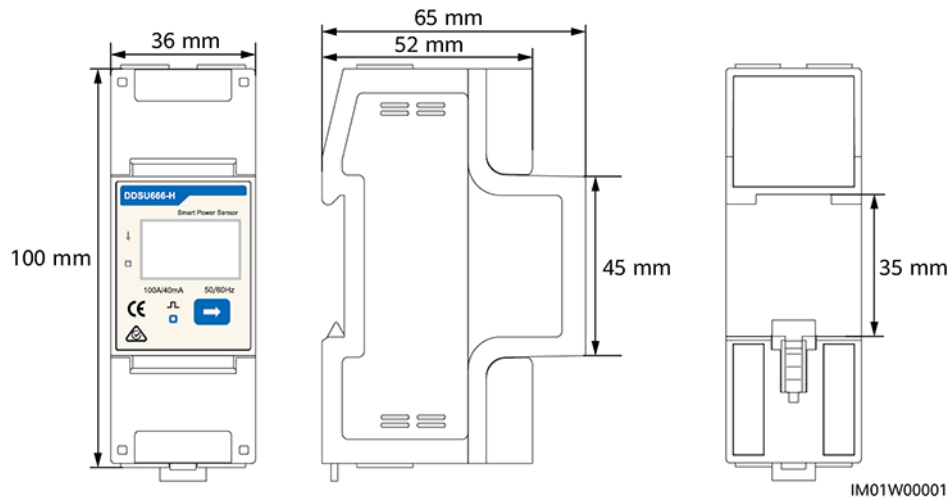

2.6 Installing the DDSU666-H

1. Install the smart power sensor on the standard din rail of DIN35 mm.
2. Install the Smart Power Sensor to the standard din rail from the top to the bottom, and then push the instrument to the din rail from the bottom to the front part.

Figure 2-8 Install the smart power sensor

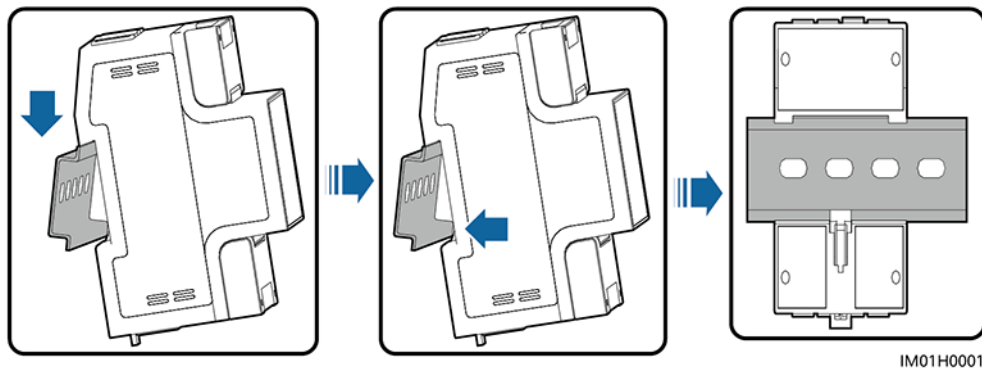

2.7 Installing the DDSU666-H Cable

Cable	DDSU666-H	Type	Conductor Cross-sectional Area Range	Outer Diameter	Source
AC power cable	L - 3 N -4	Two-core (L and N) outdoor copper cable	4-6 mm ²	10-21 mm	Prepared by the customer

Cable	DDSU666-H	Type	Conductor Cross-sectional Area Range	Outer Diameter	Source
CT cable	I* - 5	-	-	-	Manufact-urer
	I - 6	-	-	-	
Comm. cable	RS485A - 24	Two-core outdoor shielded twisted pair	0.20-1 mm ²	4-11 mm	Manufact-urer
	RS485B - 25				

 **NOTE**

- The minimum cable diameter must comply with local cable standards.
 - The factors that affect cable selection include the rated current, cable type, routing mode, ambient temperature, and maximum expected line loss.
1. Connect the L,N voltage lines to the 3, 4 terminals of the collector.
 2. Connect current transformer outlets I*, I to terminals 5, 6 of the collector.
 3. Connect RS485A and RS485B to the communication host.

Figure 2-9 Installing the DTSU666-H Cable

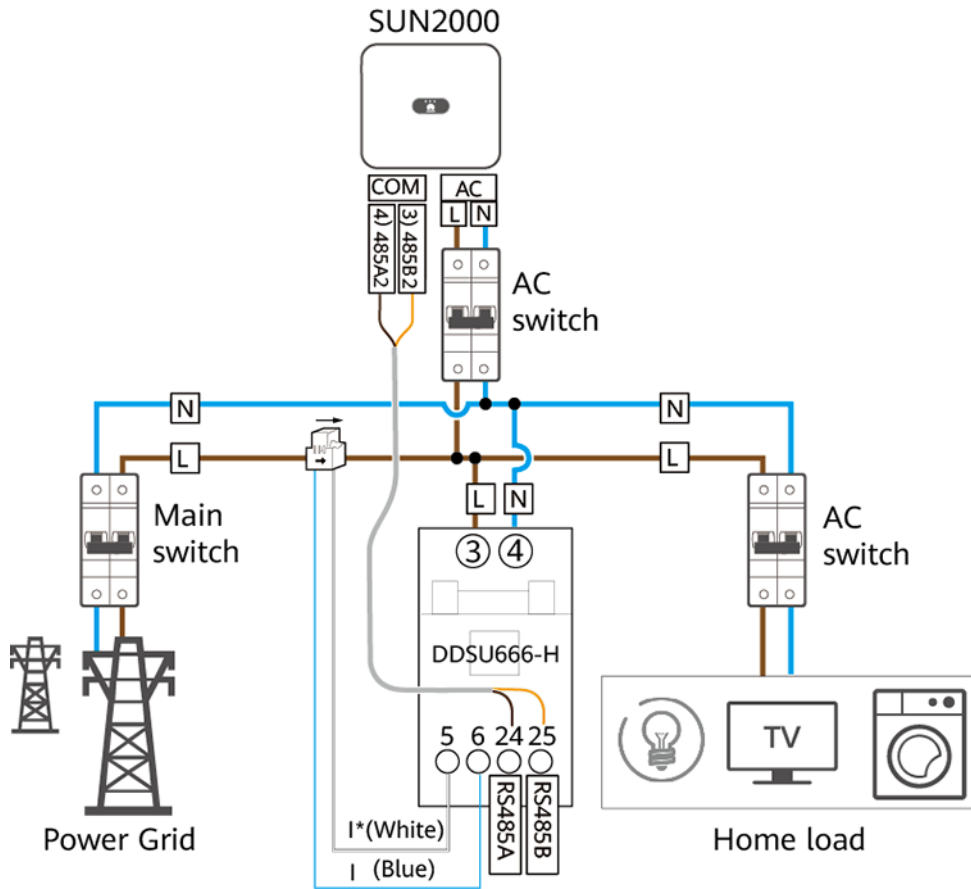

3 System Maintenance

3.1 Troubleshooting

Table 3-1 Common alarms and troubleshooting measures

Fault phenomenon	Factor analysis	Elimination method
No display after the instrument being powered on	<ol style="list-style-type: none"> 1. Incorrect wiring mode; 2. Abnormal voltage supplied for the instrument; 	<ol style="list-style-type: none"> 1. If the wiring mode is incorrect, please connect based on the correct wiring mode (see the wiring diagram). 2. If the supplied voltage is abnormal, please supply the voltage on the instrument specification.
Abnormal RS485 communication	<ol style="list-style-type: none"> 1. The RS485 communication cable is disconnected, short circuit or reversely connected. 2. The address, baud rate, data bit and parity bit of the instrument is not in accordance with the host computer; 	<ol style="list-style-type: none"> 1. If any problems for the communication cable, please reconnect or change the cable. 2. Set the address, baud rate, data bit, parity bit to be the same as the host computer through buttons, for button settings, please see parameter setting.
Inaccurate for energy metering	<ol style="list-style-type: none"> 1. Incorrect wiring, please check whether the corresponding phase sequence of voltage and current is correct. 2. Check whether the high & low end of current transformer inlet is reversely connected. Please observe the power of Pa, Pb, Pc, to be abnormal if any negative values. 	<p>If the wiring mode is incorrect, please connect based on the correct wiring mode (see the wiring diagram).</p>

 **NOTE**

Contact the installation vendor if all failure analysis procedures listed above are completed and the fault still exists.

4 Technical Specifications

4.1 Environmental Specifications

Table 4-1 Environmental specifications

Item	Specifications
Regulated working temperature range	-25°C to +60°C
Limited working temperature range	-35°C to +70°C
Relative humidity (Annual average)	≤ 75% RH
Atmospheric pressure	86–106 kPa

4.2 Main technical performance and parameter

4.2.1 Electrical parameter

Table 4-2 Electrical parameter

Regulated working voltage range	176–288 VAC
Extended working voltage range	0.7–1.3 Un
Working frequency range	45–65 Hz

4.2.2 Percentage error

Table 4-3 The percentage error of the sensor cannot exceed the following corresponding limited value

Current value		Power factor	The percentage error limitation of various grade instruments
Direct connect	Via transformer		Class 1
$0.05 I_b \leq I < 0.1 I_b$	$0.02 I_n \leq I < 0.05 I_n$	1	±1.5
$0.1 I_b \leq I \leq I_{max}$	$0.05 I_n \leq I \leq I_{max}$	1	±1.0
$0.1 I_b \leq I < 0.2 I_b$	$0.05 I_n \leq I < 0.1 I_n$	0.5 L	±1.5
		0.8 C	±1.5
$0.2 I_b \leq I \leq I_{max}$	$0.1 I_n \leq I \leq I_{max}$	0.5 L	±1.0
		0.8 C	±1.0
When users has special requirement		0.25 L	±3.5
$0.2 I_b \leq I \leq I_{max}$	$0.1 I_n \leq I \leq I_{max}$	0.5 C	±2.5

4.2.3 Start

Table 4-4 Under the referenced voltage and Table A-1, the sensor starts and continuously metering the electrical energy

Sensor	Energy meter grade	Power factor
	Class 1	
Direct connect	$0.004 I_b$	1
Via transformer	$0.002 I_b$	

4.2.4 Defluction

When applying voltage while the current circuit has no current, the test output of the instrument shall not produce a superfluous pulse. When testing, the current circuit shall be disconnected and the applied voltage of the voltage circuit shall be 115% of the referenced voltage.

$$\Delta t \geq \frac{600 \times 10^6}{k \cdot m \cdot U_n \cdot I_{max}} \text{ [min]}$$

The shortest testing time Δt :

For instrument of class 1:

From the formula: k represents energy meter constant (imp/kWh), m represents the testing component quantity, U_n represents the referenced voltage (V), I_{max} represents the large current (A).

4.2.5 Other technical parameters

Table 4-5 Other technical parameters

Scale range	0-999999.99 kWh
Communication protocol	Modbus-RTU protocol

4.3 EMC Specifications

EMC performance of the meter conforms to the following relevant technical standard:

- IEC 61326-1:2012
- IEC 61326-2-1:2012
- EN 61326-1:2013
- EN 61326-2-1:2013
- EN61000-3-2:2005/A2:2009
- EN61000-3-3:2008

4.4 Structure Specifications

4.4.1 Structure specifications

Table 4-6 Structure specifications

Item	Specifications
Installation mode	Directly stuck the sensor on the din rail and finally install it on the power distribution box. 1. When installing, please firstly stuck one side of the card slot and then forcibly stuck it on the din rail. 2. When disassembling, please use a screwdriver to forcibly hold the flexible card and then take out the sensor.
Dimensions (H x W x D)	36 mm x 100 mm x 65.5 mm (±0.5 mm)
Weight	≤ 0.3 kg

5 Acronyms and Abbreviations B

D	
DC	direct current
E	
EFT	electrical fast transient
EMI	electromagnetic interference
EMS	electromagnetic susceptibility
ESD	electrostatic discharge
M	
MPPT	maximum power point tracking
P	
PLC	power line communication
R	
RE	radiated emission
RS	radiated susceptibility