

Commercial&Industry Smart Inverter Solution

ET 15-30kW

GW60KWH-D-10 | GW60KWH-D-10(Extension)

GW61.4-BAT-AC-G10 | GW92.1-BAT-AC-G10 | GW102.4-BAT-AC-G10 |

GW112.6-BAT-AC-G10

User Manual

V1.9-2025-09-23

Copyright Statement:

Copyright © GoodWe Technologies Co., Ltd. 2025. All rights reserved.

No part of this manual can be reproduced or transmitted to the public platform in any form or by any means without the prior written authorization of GoodWe Technologies Co., Ltd.

Trademarks

GOODWE and other GOODWE trademarks are trademarks of GoodWe Technologies Co., Ltd. All other trademarks or registered trademarks mentioned in this manual are owned by the company.

NOTICE

The information in this user manual is subject to change due to product updates or other reasons. This manual cannot replace the product safety labels unless otherwise specified. All descriptions in the manual are for guidance only.

1 About This Manual

1.1 Overview

The energy storage system consists of inverter, battery system, and smart meter. This manual describes the product information, installation, electrical connection, commissioning, troubleshooting and maintenance of the system. Read through this manual before installing and operating the products. This manual is subject to update without notice. For more product details and latest documents, visit <https://en.goodwe.com/>.



1.2 Applicable Model

The energy storage system consists the following products:

Product Type	Product Information	Instructions
Inverter	ET 15-30kW	Nominal output power 15kW to 30kW.
Battery system	GW60KWH-D-10 (Extension) GW60KWH-D-10	Single cluster storage capacity of 60kWh. The maximum cluster storage capacity can reach up to 180kWh.
	GW61.4-BAT-AC-G10 GW92.1-BAT-AC-G10 GW102.4-BAT-AC-G10 GW112.6-BAT-AC-G10	Single cluster energy storage capacity 61.4/92.1/102.4/112.6kWh.
Electricity meter	GM3000	The monitoring module in energy storage system can detect operational information such as voltage and current in the system.
	GM330	
	GMK330	
smart dongle	WiFi/LAN Kit-20	System operation information can be uploaded to the monitoring platform via WiFi or LAN signals.
	LS4G Kit-CN, 4G Kit-CN, 4G Kit-CN-G20, or 4G Kit-CN-G20 (China only)	The system operation information can be uploaded to the monitoring platform via 4G signal.
	Wi-Fi Kit	The system operation information can be

Product Type	Product Information	Instructions
		uploaded to the monitoring platform via WiFi signal.
	Ezlink3000	When parallel system, it is connected to Master inverter. The system operation information can be uploaded to the monitoring platform via WiFi or LAN signals.

1.3 Symbol Definition

 DANGER
Indicates a high-level hazard that, if not avoided, will result in death or serious injury.
 WARNING
Indicates a medium-level hazard that, if not avoided, could result in death or serious injury.
 CAUTION
Indicates a low-level hazard that, if not avoided, could result in minor or moderate injury.
NOTICE
Highlights key information and supplements the texts. Or some skills and methods to solve product-related problems to save time.

2 Safety Precautions

Please strictly follow these safety instructions in the user manual during the operation.

WARNING

The products are designed and tested strictly to comply with related safety rules. Read and follow all the safety instructions and cautions before any operations. Improper operation might cause personal injury or property damage as the products are electrical equipment.

2.1 General Safety

NOTICE

- The information in this user manual is subject to change due to product updates or other reasons. This manual cannot replace the product safety labels unless otherwise specified. All descriptions in the manual are for guidance only.
- Before installations, read through the user manual to learn about the product and the precautions.
- All operations should be performed by trained and knowledgeable technicians who are familiar with local standards and safety regulations.
- Use insulating tools and wear personal protective equipment (PPE) when operating the equipment to ensure personal safety. Wear anti-static gloves, cloths, and wrist strips when touching electronic devices to protect the equipment from damage.
- Unauthorized dismantling or modification may damage the equipment, the damage is not covered under the warranty.
- Strictly follow the installation, operation, and configuration instructions in this manual. The manufacturer shall not be liable for equipment damage or personal injury if you do not follow the instructions. For more warranty details, please visit <https://www.goodwe.com/warrantyrelated.html>.

2.2 Personnel Requirements

NOTICE

- Personnel who install or maintain the equipment must be strictly trained, learn about safety precautions and correct operations.
- Only qualified professionals or trained personnel are allowed to install, operate, maintain, and replace the equipment or parts.

2.3 System Installation



DANGER

- All operations such as transportation, storage, installation, use and maintenance shall comply with applicable laws, regulations, standards and specifications.
- To protect the equipment and components from damage during transportation, ensure that the transportation personnel are professionally trained. All operations during the transportation have to be recorded. The equipment shall be kept in balance, thus avoiding falling down.
- The equipment is heavy. Please equip the corresponding personnel according to its weight, so that the equipment does not exceed the weight range of the human body can carry, and cause personnel injury.
- Keep the equipment stable to avoid dumping, which can result in equipment damage and personal injuries.
- The equipment must be installed on a concrete or other non-combustible surface. Ensure that the foundation is level, firm, flat, dry, and no depressions or slopes. The foundation should also be sturdy enough to bear mechanical load.
- Disconnect the upstream and downstream switches to power off the equipment before any electrical connections. Do not work with power on. Otherwise, an electric shock may occur.
- Install a breaker at the voltage input side of the equipment to prevent personal injury or equipment damage caused by energized electrical work.
- Perform electrical connections in compliance with local laws, regulations, standards and specifications. Including operations, cables, and component specifications.
- Connect cables using the connectors included in the package. The manufacturer shall not be liable for equipment damage if other connectors are used.
- Ensure all cables are connected tightly, securely, and correctly. Inappropriate wiring may cause poor contacts and damage the equipment.
- Ensure that the system is securely grounded before operations. Otherwise, an electric shock may occur.
- Ensure that the equipment is not damaged and the system is not faulty before any operations. Otherwise, fire or electric shock may occur.
- Do not open the cabinet door or touch any terminals or components while the equipment is working. Otherwise, an electric shock may occur.
- Do not touch running equipment as its temperature may exceed 60°C and result burning harm. Do not install equipment within reach of non-professionals.
- Do not wear any metal thing when moving, installing, or commissioning the equipment. Otherwise, it will cause electrical shock or damages to the equipment.
- Do not put any metal parts on the equipment, otherwise it will cause electrical shock.



WARNING

- Do not apply mechanical load to the terminals, otherwise the terminals can be damaged.
- If the cable bears too much tension, the connection may be poor. Reserve a certain length

of the cable before connecting it to corresponding ports.

- Tie the cables of the same type together, and place cables of different types at least 30mm apart. Do not place the cables entangled or crossed.
- Place the cables at least 30mm away from the heating components or heat sources, otherwise the insulation layer of the cables may be aging or broken due to high temperature.

2.3.1 PV String Safety



- Ensure the component frames and the bracket system are securely grounded.
- Ensure the DC cables are connected tightly, securely and correctly. Inappropriate wiring may cause poor contacts or high impedance, and damage the inverter.
- Measure the DC cable using the multimeter to avoid reverse polarity connection. Also, the voltage should be within the permissible range.
- Measure the DC cable using the multimeter to avoid reverse polarity connection. Also, the voltage should be under the max DC input voltage. The manufacturer shall not be liable for the damage caused by reverse connection and overvoltage.
- The PV strings cannot be grounded. Ensure the minimum insulation resistance of PV string to the ground meets the minimum insulation resistance requirements before connecting the PV string to the inverter ($R = \text{maximum input voltage (V)} / 30\text{mA}$).
- Do not connect one PV string to more than one inverter at the same time. Otherwise, it may cause damage to the inverter.
- The PV modules used with the inverter must have an IEC61730 class A rating.
- The inverter output power may decrease if the PV string inputs high voltage or current.

2.3.2 Inverter Safety



- The voltage and frequency at the connecting point should meet the on-grid requirements.
- Additional protective devices like circuit breakers or fuses are recommended on the AC side. Specification of the protective device should be at least 1.25 times the maximum AC output current.
- The arc fault alarms will be cleared automatically if the alarms are triggered less than 5 times in 24 hours. The inverter will shutdown for protection after the 5th electric arc fault. The inverter can operate normally after the fault is solved.
- BACK-UP is not recommended if the PV system is not configured with batteries. Otherwise, there may be a risk of system power outage.
- The inverter output power may decrease when the grid voltage and frequency changes.

2.3.3 Battery Safety



- The Battery system is a high-voltage system, and high voltage is present during equipment operation. Before operating any equipment in the system, ensure that the equipment has been POWER OFF to prevent electric shock DANGER. Strictly adhere to all Safety Precautions in this manual and the safety labels on the equipment during operation.
- This Battery system is a high-voltage system. Keep away unless you are a qualified professional. Do not touch or operate without permission.
- This energy storage system is classified as heavy-duty equipment. During Installation and maintenance, use appropriate equipment and tools and implement Protection measures. Improper operation may result in personal injury or product damage.
- Do not disassemble, modify, or repair the Battery or control unit without official authorization from the equipment manufacturer, as it may result in electric shock DANGER or equipment damage. beyond the manufacturer's liability shall be liable for any losses incurred.
- The equipment must be installed on concrete or other non-combustible surfaces, ensuring the foundation is level, sturdy, flat, dry, and has sufficient load-bearing capacity. Depressions or tilting are prohibited.
- Do not impact, pull, drag, squeeze, step on the equipment or puncture the equipment casing with sharp objects, and do not place the Battery in fire, otherwise the Battery may explode.
- Do not place the Battery in a high-temperature environment. Ensure there are no heat sources near the Battery and that it is not exposed to direct sunlight. A fire may occur if the ambient temperature exceeds 60°C.
- Do not use if Battery or control unit show obvious defects, cracks, damage, or other conditions. Damage to Battery may result in electrolyte leakage.
- Do not move the Battery system while the Battery is in operation.
- When Installation Battery system, ensure correct polarity of the positive and negative terminals. Do not reverse the polarity, as this may cause a short circuit, leading to personal injury or property damage.
- Never short-circuit the positive and negative terminals of the Battery. Short-circuiting the Battery may cause personal injury, and the instantaneous high current generated by a short circuit can release a large amount of energy, potentially leading to a fire.
- When operating the equipment, ensure that the equipment is not damaged and the system has no fault, otherwise there may be a risk of electric shock and fire.
- Do not open the equipment cabinet door or touch any wiring terminals or components during operation. Otherwise, there is a risk of electric shock.
- The temperature of the enclosure may exceed 60°C during operation. Do not touch the enclosure before it cools down; ensure it is not Installation within reach of non-professional personnel.
- During operation, do not plug or unplug the terminal or connecting cables, as this may pose a safety hazard.
- During operation, if any abnormal conditions occur, immediately Battery system the

POWER OFF and promptly contact the relevant personnel for handling.



- Ensure timely Charge after Battery discharge, otherwise it may cause excessive Discharge of Battery, leading to Battery damage.
- Do not use more than The nominal charging and discharging current pairs of Battery to charge Discharge.
- Battery current may be affected by factors such as temperature, Humidity, and weather conditions, which could lead to Battery current limiting and impact load-carrying capacity.
- If the Battery fails to start, please contact the after-sales service center as soon as possible. Otherwise, the Battery may be permanently damaged.
- If the battery module needs to be replaced or battery module needs to be added, please contact the after-sales service center.
- Avoid performing Battery charge under low-temperature conditions, as it may lead to a reduction in Battery system capacity.
- Do not place unrelated items into any part of the battery cabinet.

Emergency Measures

● **Battery Electrolyte Leakage**

If the battery module leaks electrolyte, avoid contact with the leaking liquid or gas. The electrolyte is corrosive. It will cause skin irritation or chemical burn to the operator. Anyone contact the leaked substance accidentally has to do as following:

- **Breath in the leaked substance:** Evacuate from the polluted area, and seek immediate medical assistance.
- **Eye contact:** Rinse your eyes for at least 15 minutes with clean water and seek immediate medical assistance.
- **Skin contact:** Thoroughly wash the touch area with soap and clean water, and seek immediate medical assistance.
- **Ingestion:** Induce vomiting, and seek immediate medical assistance.

● **Fire**

- The battery may explode when the ambient temperature exceeds 150°C. Poisonous and hazardous gas may be released if the battery is on fire.
- In the event of a fire, please make sure that the carbon dioxide extinguisher or Novec1230 or FM-200 is nearby.
- The fire cannot be put out by ABC dry powder extinguisher. Firefighters are required to wear full protective clothing and self-contained breathing apparatus.

2.3.4 Smart Meter Safety







WARNING











If the voltage of the power grid fluctuates, resulting in the voltage to exceed 265V, in this case, long-term overvoltage operation may cause damage to the meter. It is recommended to add a fuse with a rated current of 0.5A on the voltage input side of the meter to protect it.







2.4 Safety Symbols And Certification Marks

DANGER

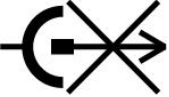
- All labels and warning marks should be visible after the installation. Do not cover, scrawl, or damage any label on the equipment.
- The following descriptions are for reference only.

No.	Symbol	Descriptions
1		Potential risks exist. Wear proper personnel protective equipment before any operations.
2		HIGH VOLTAGE HAZARD Disconnect all incoming power and turn off the product before working on it.
3		High-temperature hazard. Do not touch the product under operation to avoid being burnt.
4		Operate the equipment properly to avoid explosion.
5		Batteries contain flammable materials, beware of fire.
6		The equipment contains corrosive electrolytes. In case of a leak in the equipment, avoid contact the leaked liquid or gas.

No.	Symbol	Descriptions
7		Delayed discharge. Wait 5 minutes after power off until the components are completely discharged.
8		Install the equipment away from fire sources.
9		Keep away from children
10		Operate the equipment properly to avoid explosion.
11		Batteries contain flammable materials, beware of fire.
12		Do not lift the equipment after wiring or when the equipment is working.
13		Do not pour with water.
14		Read through the user manual before any operations.
15		Wear personal protective equipment during installation, operation and maintaining.
16		Do not dispose of the System as household waste. Deal with it in compliance with local laws and regulations, or send it back to the manufacturer.

No.	Symbol	Descriptions
17		Do not disconnect or plug and unplug the DC connectors during the operation of the equipment.
18		Grounding point.
19		Recycle regeneration mark.
20		CE mark
21		TUV mark
22		RCM mark

2.5 EU Declaration of Conformity

2.5.1 Equipment With Wireless Communication Modules

GoodWe Technologies Co., Ltd. hereby declares that the equipment with wireless communication modules sold in the European market meets the requirements of the following directives:

- Radio Equipment Directive 2014/53/EU (RED)
- Restrictions of Hazardous Substances Directive 2011/65/EU and (EU) 2015/863 (RoHS)
- Waste Electrical and Electronic Equipment 2012/19/EU
- Registration, Evaluation, Authorization and Restriction of Chemicals (EC) No 1907/2006 (REACH)

2.5.2 Equipment Without Wireless Communication Modules

(Except Battery)

GoodWe Technologies Co., Ltd. hereby declares that the equipment without wireless communication modules sold in the European market meets the requirements of the following

directives:

- Electromagnetic compatibility Directive 2014/30/EU (EMC)
- Electrical Apparatus Low Voltage Directive 2014/35/EU (LVD)
- Restrictions of Hazardous Substances Directive 2011/65/EU and (EU) 2015/863 (RoHS)
- Waste Electrical and Electronic Equipment 2012/19/EU
- Registration, Evaluation, Authorization and Restriction of Chemicals (EC) No 1907/2006 (REACH)

2.5.3 Battery

GoodWe Technologies Co., Ltd. hereby declares that batteries sold in the European market meets the requirements of the following directives:

- Electromagnetic compatibility Directive 2014/30/EU (EMC)
- Electrical Apparatus Low Voltage Directive 2014/35/EU (LVD)
- Battery Directive 2006/66/EC and Amending Directive 2013/56/EU
- Waste Electrical and Electronic Equipment 2012/19/EU
- Registration, Evaluation, Authorization and Restriction of Chemicals (EC) No 1907/2006 (REACH)

You can download the EU Declaration of Conformity on the official website:

<https://en.goodwe.com>.

3 System Introduction

3.1 System Overview



- Select the battery model according to the inverter model and the approved battery list. For battery requirements used in the same system, such as whether the models can be mixed and matched, and whether the capacities are consistent, please refer to the corresponding model's battery user manual or contact the battery manufacturer for relevant requirements. Compatibility Overview :
https://en.goodwe.com/Ftp/EN/Downloads/User%20Manual/GW_Battery%20Compatibility%20Overview-EN.pdf.
- Due to product upgrades or other reasons, the document content may be updated irregularly. The matching relationship between inverters and IoT products can refer to:
https://en.goodwe.com/Ftp/EN/Downloads/User%20Manual/GW_Compatibility-list-of-GoodWe-inverters-and-IoT-products-EN.pdf.
- When the inverter is in off-grid status, it can be used normally for ordinary household loads. However, the following loads must be restricted:
 - Inductive loads: Single Inductive loads power <math>< 0.4</math> times of the inverter's phase rated output power.
 - Capacitive loads: Total power $\leq 0.66 \times$ inverter rated output power.
 - When connecting three-phase loads to the BACK-UP port, only three-phase loads with an N line are supported. Loads without an N line are not supported, as this may cause abnormal operation.
 - The inverter does not support half-wave load. Half-wave load: Some older or non-EMC-compliant appliances (such as hair dryers or small heaters using half-wave rectification) may not function properly.

Commercial and Industrial Intelligent Inverter Solution integrates Inverter, Battery, Smart Meter, smart dongle, and other equipment. In the photovoltaic system, it converts solar energy into electricity to meet the power demands of commercial and industrial applications. The energy IoT devices in the system monitor and control the power consumption by identifying the overall power status, enabling intelligent management of electricity for load usage, storage in Battery, or export to Utility grid.

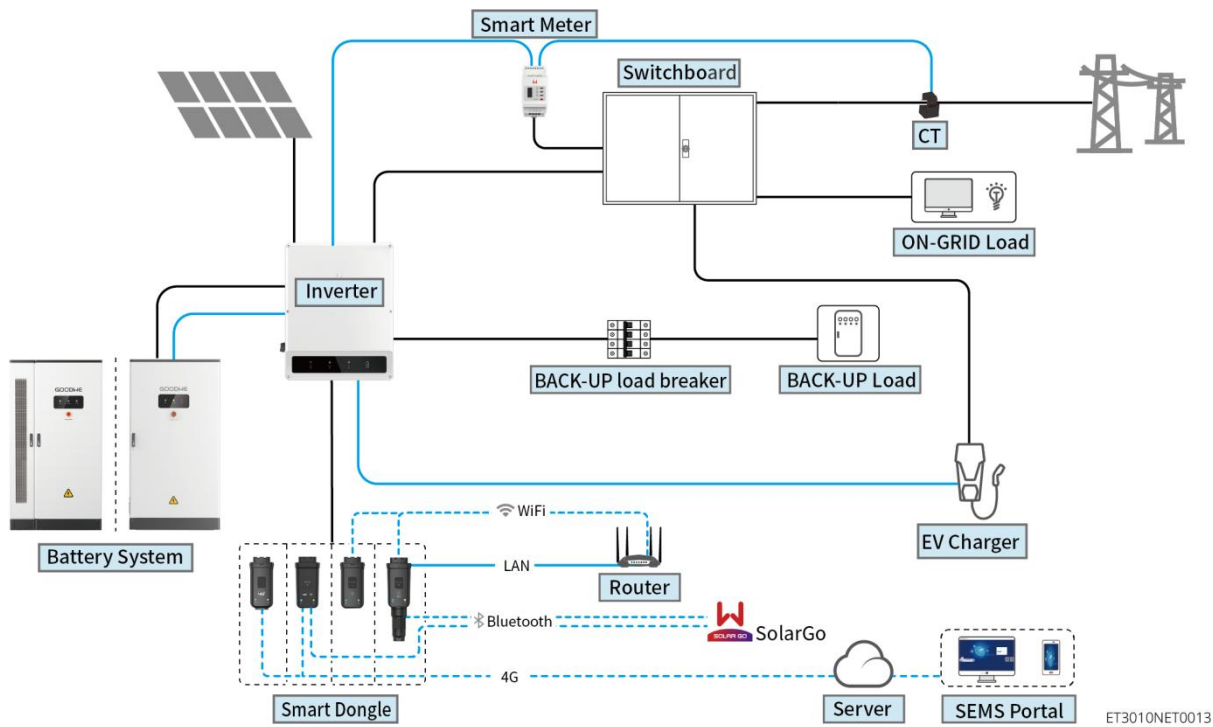

ET3010NET0013

Equipment Type	model	Instructions
Inverter	GW15K-ET GW20K-ET GW25K-ET GW29.9K-ET GW30K-ET	Supports up to 4 Inverter units to form a parallel system. The following version requirements must be met when connecting units in parallel to the grid: <ul style="list-style-type: none"> ● All Inverter software versions in the parallel system are consistent. ● The ARM software version is 08(401) or higher. ● Inverter DSP software version is 07(7068) or above
Battery system	Battery A: GW60KWH-D-10 GW60KWH-D-10 (Extension)	The system supports a maximum of 3 clusters of Battery system in parallel connection.
	Battery B: GW61.4-BAT-AC-G10 GW92.1-BAT-AC-G10 GW102.4-BAT-AC-G10 GW112.6-BAT-AC-G10	Supports single cluster only. When paired with BAT Battery, the following version requirements must be met: <ul style="list-style-type: none"> ● Inverter ARM software version is 14(440) or above ● Inverter DSP software version is 10 (10048) or above

Equipment Type	model	Instructions
Smart Meter	GM3000 GM330 GMK330	<ul style="list-style-type: none"> ● GM3000: Supplied with Inverter, CT cannot be replaced, CT ratio: 120A/40mA ● GM330: CT can be sourced from GoodWe or purchased separately, with a CT ratio requirement of nA/5A. <ul style="list-style-type: none"> ➢ nA: CT primary side input current, with n ranging from 200-5000 ➢ 5A: CT secondary side output current ● GMK330: CT shipped with the meter, CT ratio: <ul style="list-style-type: none"> ➢ 120A: 40mA ➢ 200A: 50mA (Brazil only)
smart dongle	WiFi/LAN Kit-20 Wi-Fi Kit LS4G Kit-CN, 4G Kit-CN, 4G Kit-CN-G20, or 4G Kit-CN-G21 (China only) Ezlink3000	<ul style="list-style-type: none"> ● For single-unit operation, please use the WiFi/LAN Kit-20, Wi-Fi Kit, LS4G Kit-CN, 4G Kit-CN, 4G Kit-CN-G20, or 4G Kit-CN-G21 module. If replacing the Wi-Fi Kit with the WiFi/LAN Kit-20, ensure to upgrade the InverterARM firmware to version 08.401 or above before switching to the WiFi/LAN Kit-20. ● During parallel operation, only the Master inverter needs to be connected to the Ezlink3000, while the Slave inverter does not require connection to the smart dongle. The firmware version of Ezlink3000 is 04 or above.

3.2 Product Overview

3.2.1 Inverter

Inverters control and optimize the power in PV systems through an integrated energy management system. The power generated in the PV system can be used, stored in the battery, output to the utility grid, etc.

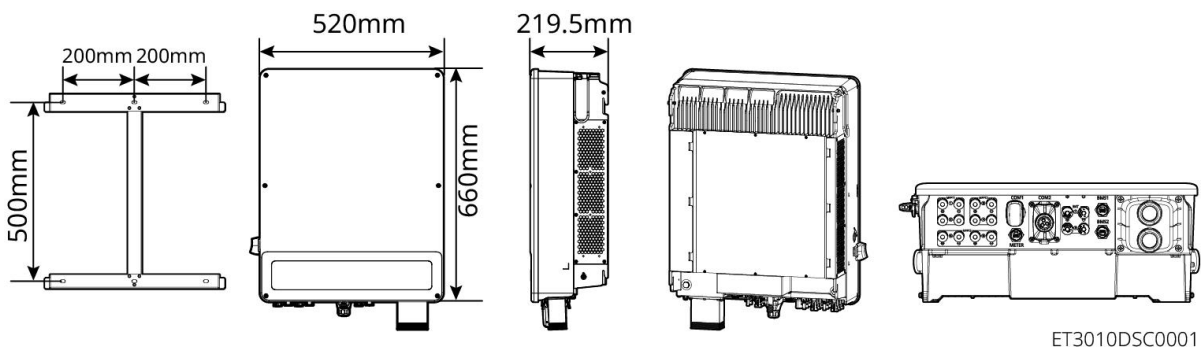

No.	Model	Nominal output power	Nominal output voltage
1	GW15K-ET	15kW	380/400V, 3L/N/PE
2	GW20K-ET	20kW	380/400V, 3L/N/PE
3	GW25K-ET	25kW	380/400V, 3L/N/PE
4	GW29.9K-ET	29.9kW	380/400V, 3L/N/PE
5	GW30K-ET	30kW	380/400V, 3L/N/PE

3.2.2 Battery

The battery system is composed of PCU and battery modules.

The battery system can store and release electricity according to the requirements of the PV energy storage system, and the input and output ports of the energy storage system are all high-voltage direct current.

NOTICE

The battery system does not support adding packs to increase capacity.

- **GW60KWH-D-10, GW60KWH-D-10 (Extension)**

No.	Model	Usable energy (kWh)	AC cabinet
1	GW60KWH-D-10	60	Yes
2	GW60KWH-D-10 (Extension)	60	No

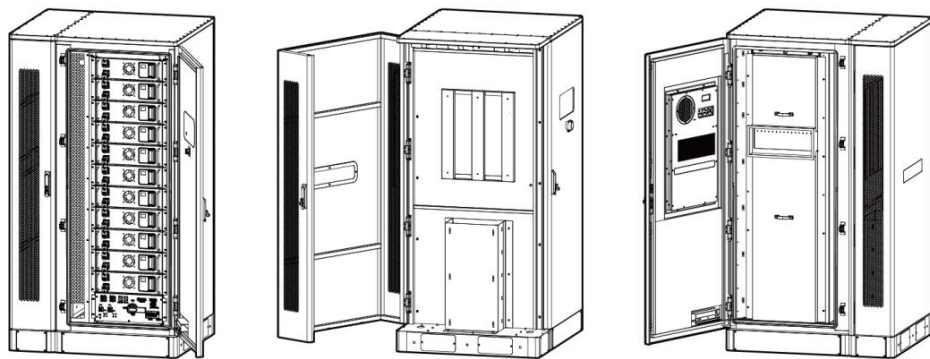
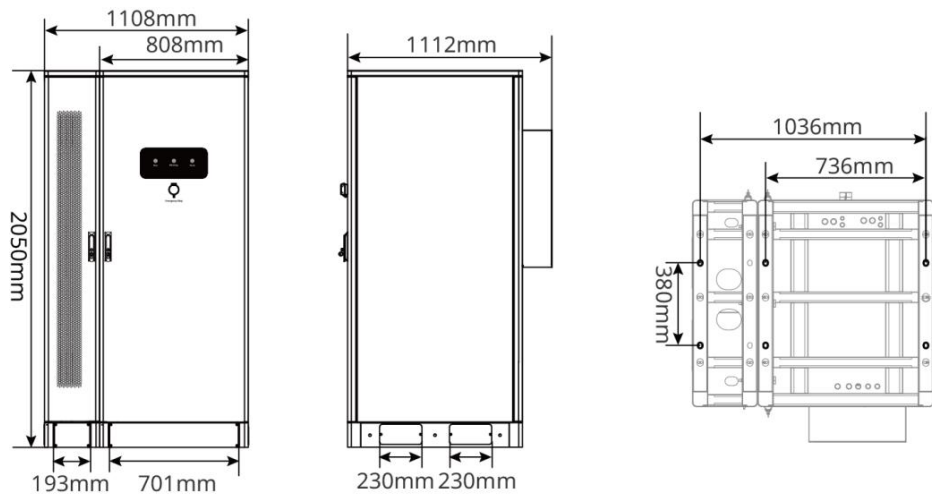

LXC6010DSC0001

- **GW61.4-BAT-AC-G10, GW92.1-BAT-AC-G10, GW102.4-BAT-AC-G10, GW112.6-BAT-AC-G10**

No.	Model	Battery Module Quantity	Usable energy (kWh)
1	GW61.4-BAT-AC-G10	6	61.4
2	GW92.1-BAT-AC-G10	9	92.1
3	GW102.4-BAT-AC-G10	10	102.4
4	GW112.6-BAT-AC-G10	11	112.6

■ Component Introduction

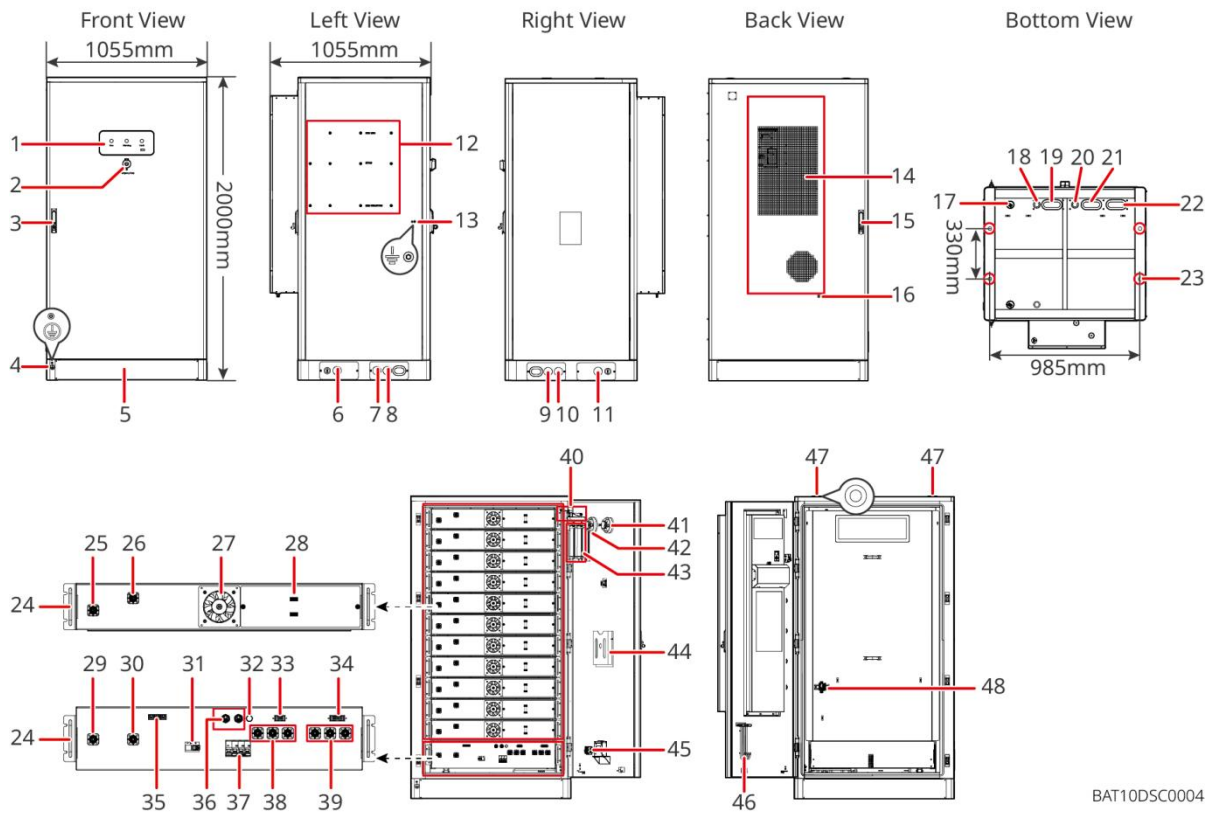

BAT10D5C0004

NO.	Name	Explanation
1	LED indicator	-
2	Emergency stop button	Press the emergency stop button and the battery system will be powered off
3	Front door lock	-
4	PE port 1	Connect the battery grounding cable
5	Bottom panel	-
6	Left cable entry hole 1	Air conditioner power cable&ET100 power cable
7	Left cable entry hole 2	Inverter communication cable
8	Left cable entry hole 3	Inverter power cable
9	Right cable entry hole 1	Battery power cable
10	Right cable entry hole 2	Battery communication cable
11	Right cable entry hole 3	Air conditioner power cable
12	Mounting plate installation hole	Inverter mounting plate installation hole
13	PE port 2	Connect the inverter grounding cable
14	Air conditioner	-
15	Back door lock	-
16	Air conditioner water pipe installation port	Air conditioner water pipe installation port
17	Ventilation valve	-
18	Communication cable inlet and outlet (bottom)	For communication cable between battery and inverter
19	Power cable inlet and	For power cable between battery and inverter

NO.	Name	Explanation
	outlet (bottom)	
20	Battery communication cable port	Communication cable port for battery parallel connection
21	Battery Power Cable Port (Positive)	Parallel Battery Power Cable Port (Positive)
22	Battery Power Cable Port (Negative)	Parallel Battery Power Cable Port (Negative)
23	Foundation fixing hole	Used to fasten the battery system and foundation are together
24	Handle	Used to fasten the battery pack to the battery cabinet
25	Battery pack power input/output port (positive)	-
26	Battery pack power input/output port (negative)	-
27	Fan	-
28	Battery pack communication port	Communication between neighbouring battery packs, communication with the high-voltage box, power supply for fans
29	High-voltage box power input / output port (negative) 1	Connect the power cable between the high-voltage box and battery packs
30	High-voltage box power input / output port (positive) 1	
31	Molded case circuit breaker	Control the high-voltage output of battery system
32	Black start button	Control the black start of the battery system

NO.	Name	Explanation
33	Internal communication port 1	For the battery pack communication and the power supply of battery pack fan
34	Internal communication port 2	For the air conditioning communication, power access control switch identification, emergency stop and fire signal communication
35	LAN communication port	Reserved
36	External communication port 1	Communication with inverters / Placement of termination resistors / Battery system parallel connection communication
37	Air switch	Control the weak power supply of the battery system
38	High-voltage box power input / output port (positive) 2	Connect the power cable between the high-voltage box and the inverters
39	High-voltage box power input / output port (negative) 2	
40	Power access control switch	It is opened automatically after the door is opened to ensure that the energy storage system is powered off.
41	Temperature alarm	<p>The heat detector monitors temperature and provides a voltage output proportional to the external air temperature by using either a dual thermistor network. One thermistor is exposed to give good thermal contact with the surrounding air while the other thermistor is thermally insulated and it emits red light to remind the operator when detecting abnormality.</p> <ul style="list-style-type: none"> • Ideal for environments that are dirty or smoky under normal circumstances • Wide operating voltage
42	Smoke alarm	<p>The smoke detector uses the scattered light principle to detect smoke entering the chamber located within the detector housing.</p> <ul style="list-style-type: none"> • Responds well to slow burning, smouldering fires • Unaffected by wind or atmospheric pressure • Flashing LED and magnet operated test switch option on selected detectors • Alarm indicator: Clear light emitting diode (LED) emitting red

NO.	Name	Explanation
		light
43	Aerosol fire extinguishing device	Monitor the fire signal in the cabinet and implement fire extinguishing. When a fire occurs, the fire extinguishing device ignites the thermal line after receiving the electric start signal or the open fire, and the electric initiator or thermal line burns and activates the aerosol generator in the fire extinguishing device. The aerosol generator decomposes the chemical coolant through the heat released by a series of reactions, so that the aerosol generator and the coolant can be combined to fight against the fire.
44	Document rack	-
45	Fire action signal port	Connect the audible and visual alarm cable
46	Maintenance hook rack	To place the maintenance hook which is used to remove the packs and PCU
47	Ring mounting hole	-
48	Air conditioning switch	For connecting the air conditioner wiring cable and controlling the air conditioner power supply

■ Firefighting Logic

The cabinet is equipped with an aerosol fire suppression system. When smoke and heat detectors simultaneously detect a fire (or an open flame ignites the pyroelectric fuse), an electrical signal is output. This signal electrically activates the fire suppression device (or the pyroelectric fuse ignites the device). This activation triggers the aerosol generator within the suppression device. The aerosol generator produces the extinguishing agent through a combustion reaction. The heat released during this reaction decomposes the chemical coolant. The aerosol extinguishing agent and coolant work synergistically to extinguish the fire. Upon aerosol activation, a synchronized feedback signal is output, changing the dry contact state from NC (Normally Closed) to NO (Normally Open). This feedback signal is passive and can externally trigger audible and visual alarm devices.

Actual Power Supply 24Vdc

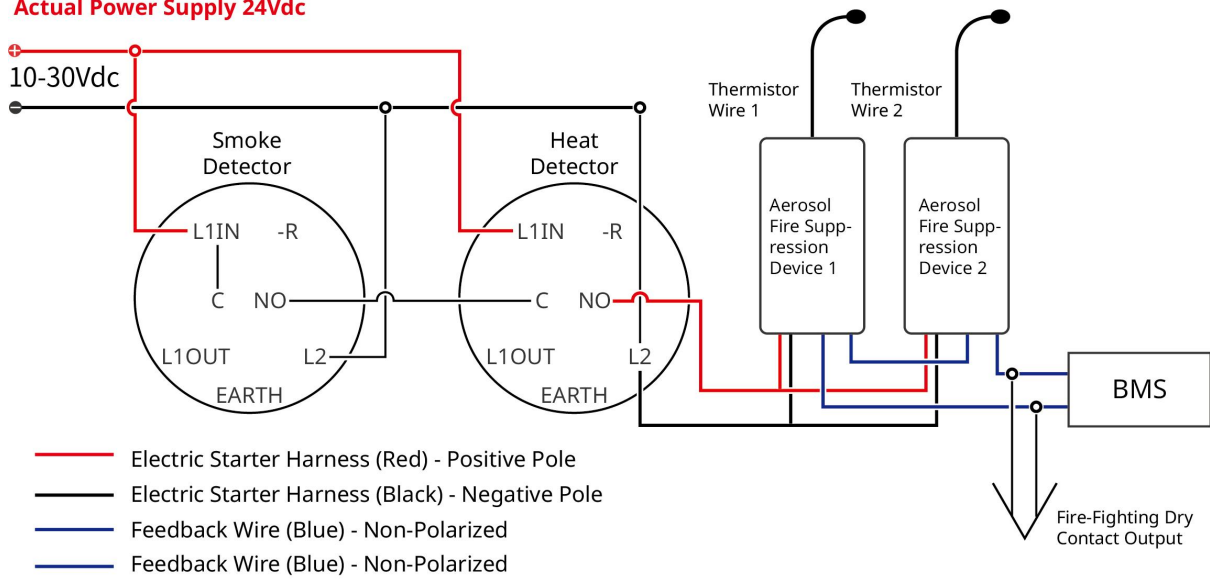

BAT10DSC0008

3.2.3 Smart Meter

Smart Meter can measure parameters such as Utility gridvoltage, current, Power, Frequency, and electrical energy, and transmit the information to Inverter to control the input and output Power of energy storage system.

GM3000&CT

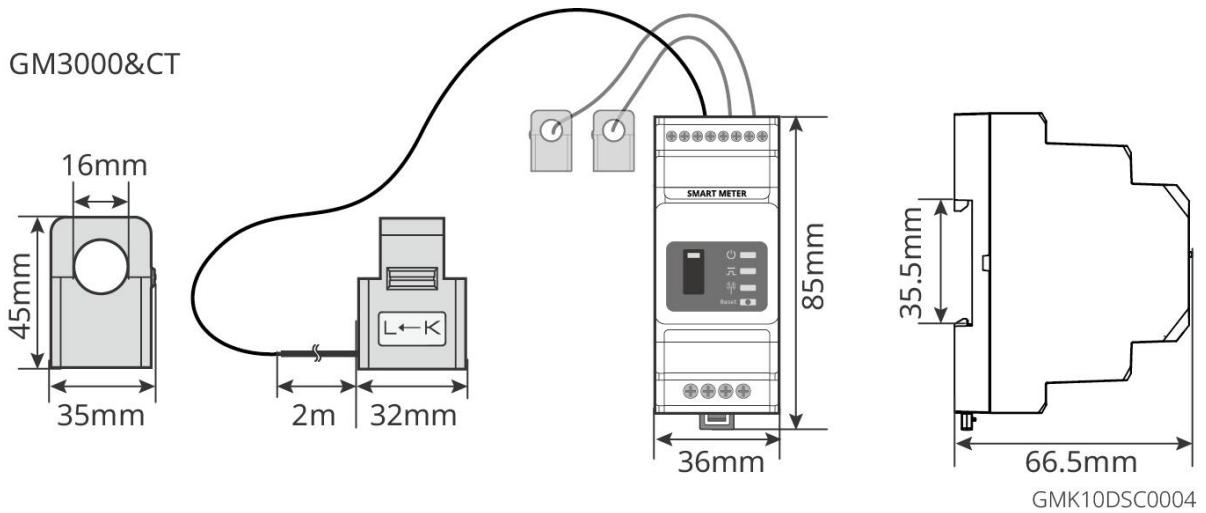

GMK10DSC0004

GM330&GMK330&CT

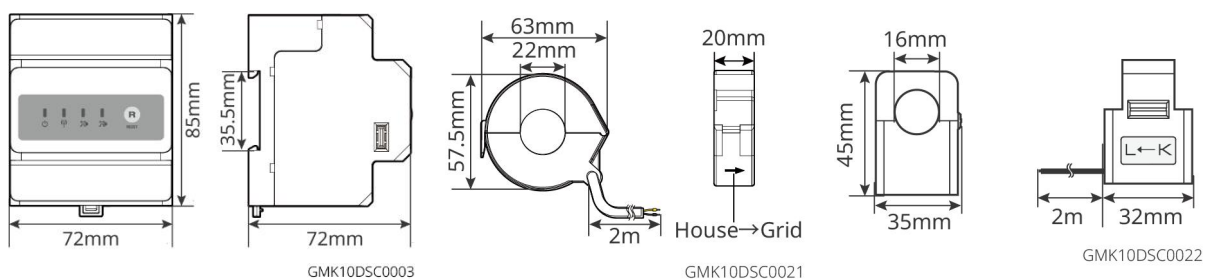

GMK10DSC0003

GMK10DSC0021

GMK10DSC0022

No.	model	Applicable scenarios
1	GM3000	CT replacement is not supported; CT ratio: 120A/40mA
2	GM330	CT can be sourced from GoodWe or purchased separately, with a CT ratio requirement of nA/5A. <ul style="list-style-type: none"> ● nA: CT primary side input current, with n ranging from 200-5000 ● 5A: CT secondary side output current
3	GMK330	CT is shipped with the meter, CT ratio: <ul style="list-style-type: none"> ● 120A: 40mA ● 200A: 50mA (Brazil only)

3.2.4 Smart Dongle

The smart dongle can transmit various power generation data to SEMS Portal, the remote monitoring platform, in real time. And connect to the SolarGo app to complete local equipment commissioning.

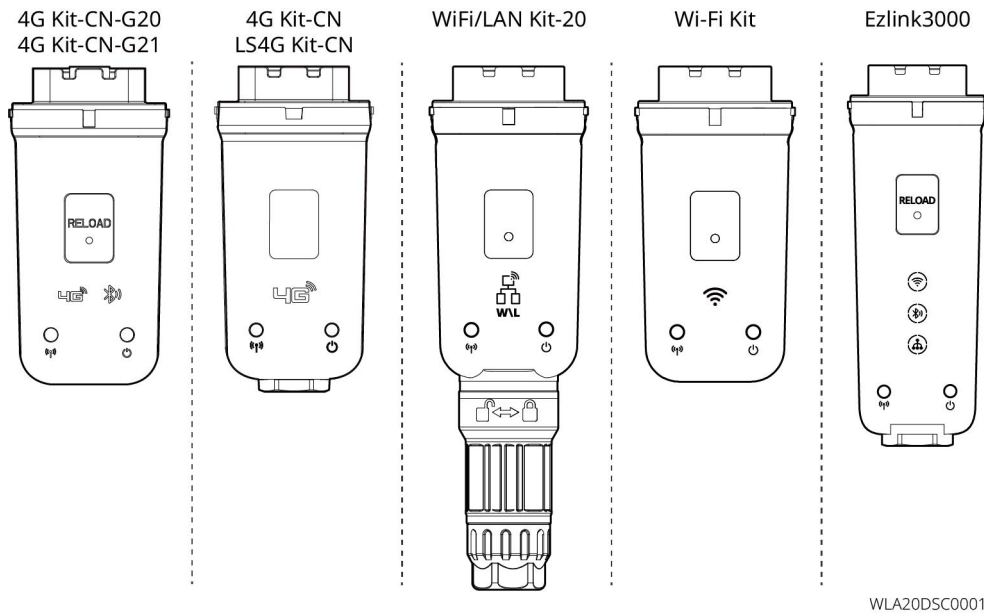

No.	Model	Signal	Applicable scenarios
1	Wi-Fi Kit	WiFi	Single inverter
2	WiFi/LAN Kit-20	WiFi, LAN, bluetooth	
3	LS4G Kit-CN 4G Kit-CN	4G	

4	4G Kit-CN-G20	4G, bluetooth	
	4G Kit-CN-G21	4G, Bluetooth, CNSS	
5	Ezlink3000	WiFi, LAN, bluetooth	Master inverter of the parallel connected inverters

3.3 Supported Grid Types

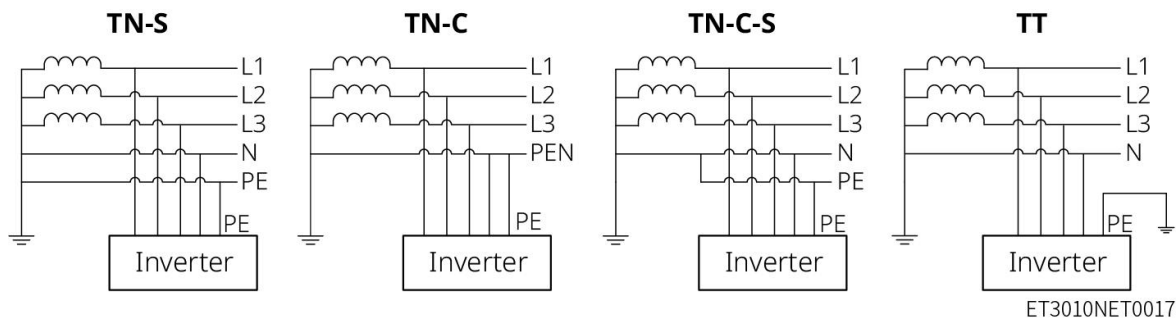

3.4 System Working Mode

Self-use Mode

- Self-use mode is the basic working mode of the system.
- When the power generated in the PV system is sufficient, it will supply the loads in priority. The excess power will charge the batteries first, then the remaining power will be sold to the utility grid. When the power generated in the PV system is insufficient, the battery will supply the loads in priority. If the battery power is insufficient, the load will be powered by the utility grid.

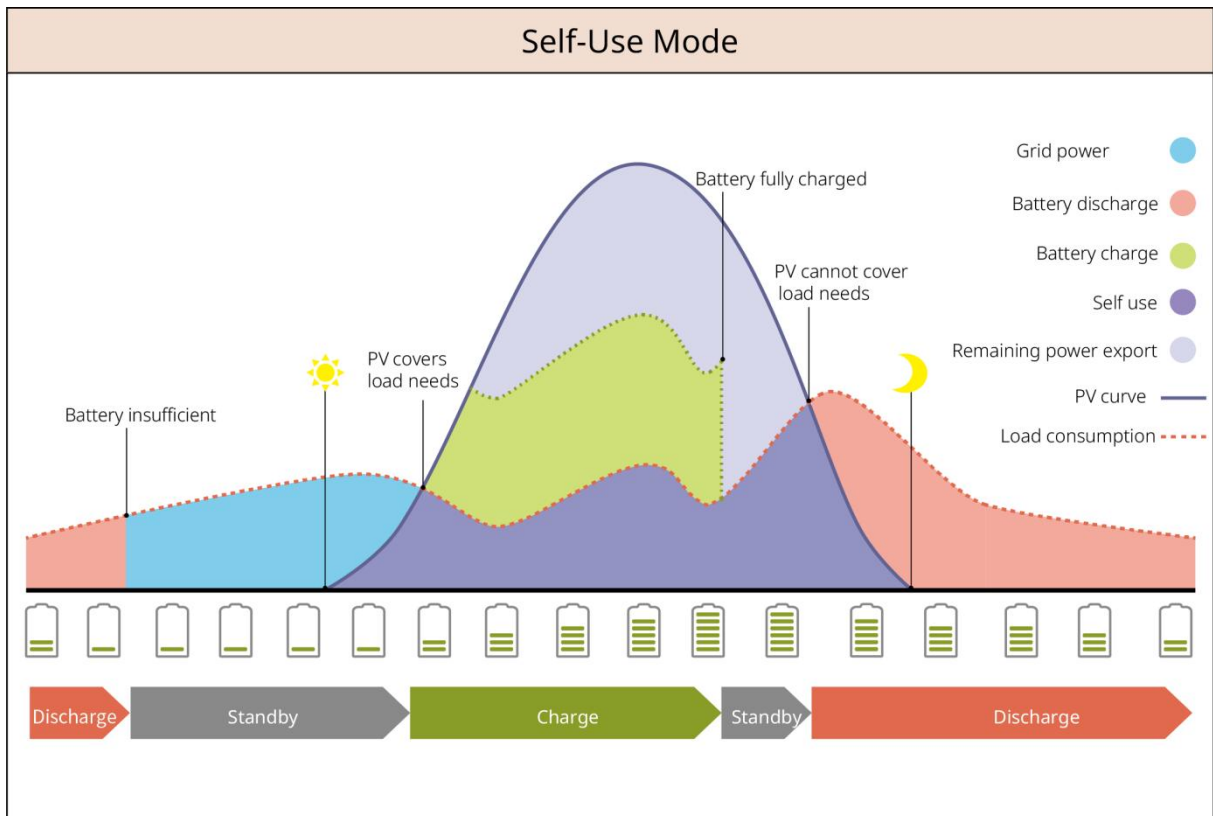

SLG00NET0009

Back-up mode

- The back-up mode is mainly applied to the scenario where the grid is unstable.
- When the grid is disconnected, the inverter turns to off-grid mode and the battery will supply power to the BACK-UP loads; when the grid is restored, the inverter switches to grid-tied mode.
- The battery will be charged to preset SOC protection value by utility grid or PV when the system is running on-grid. So that the battery SOC is sufficient to maintain normal working when the system is off-grid. The purchase of electricity from the power grid to charge the battery must comply with local laws and regulations.

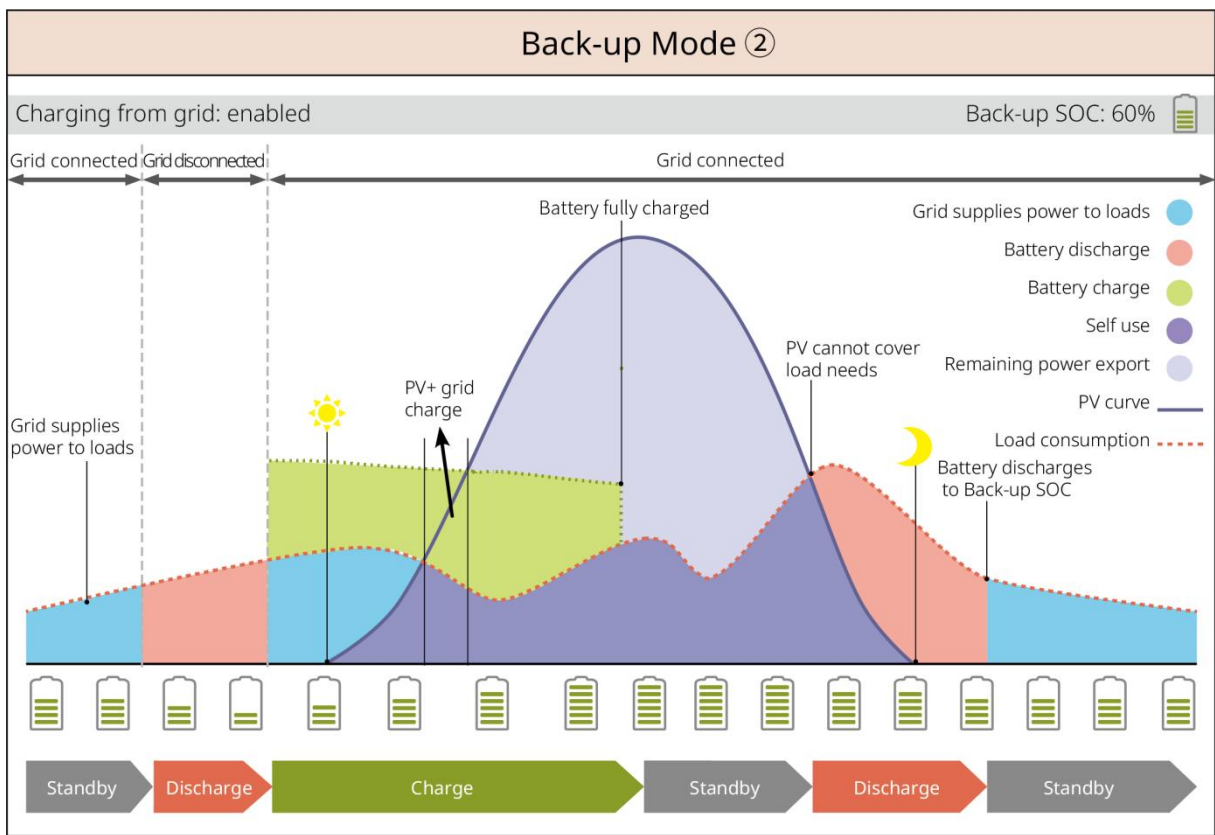
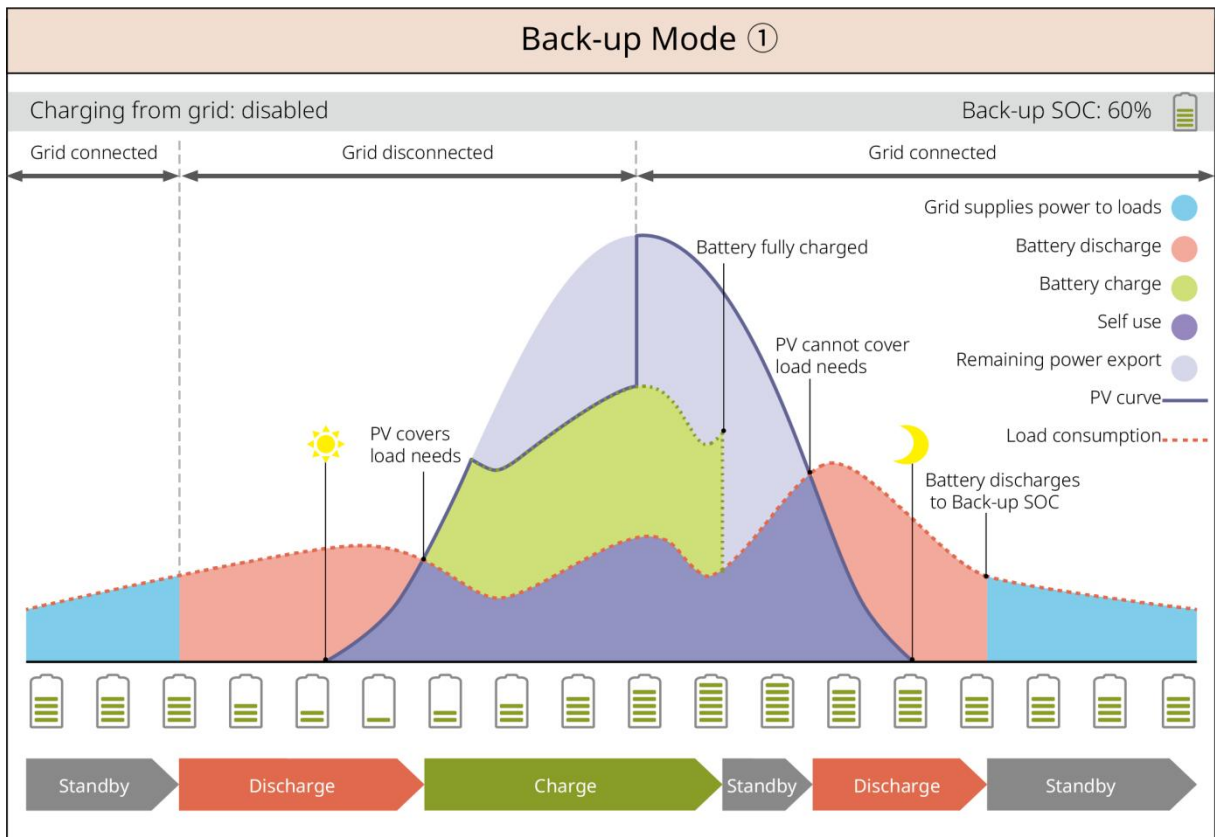

Economic mode

It is recommended to use economic mode in scenarios when the peak-valley electricity price varies a lot. Select economic mode only when it meets the local laws and regulations.

For example, set the battery to charge mode during Valley period to charge battery with grid power. And set the battery to discharge mode during Peak period to power the load with the battery.

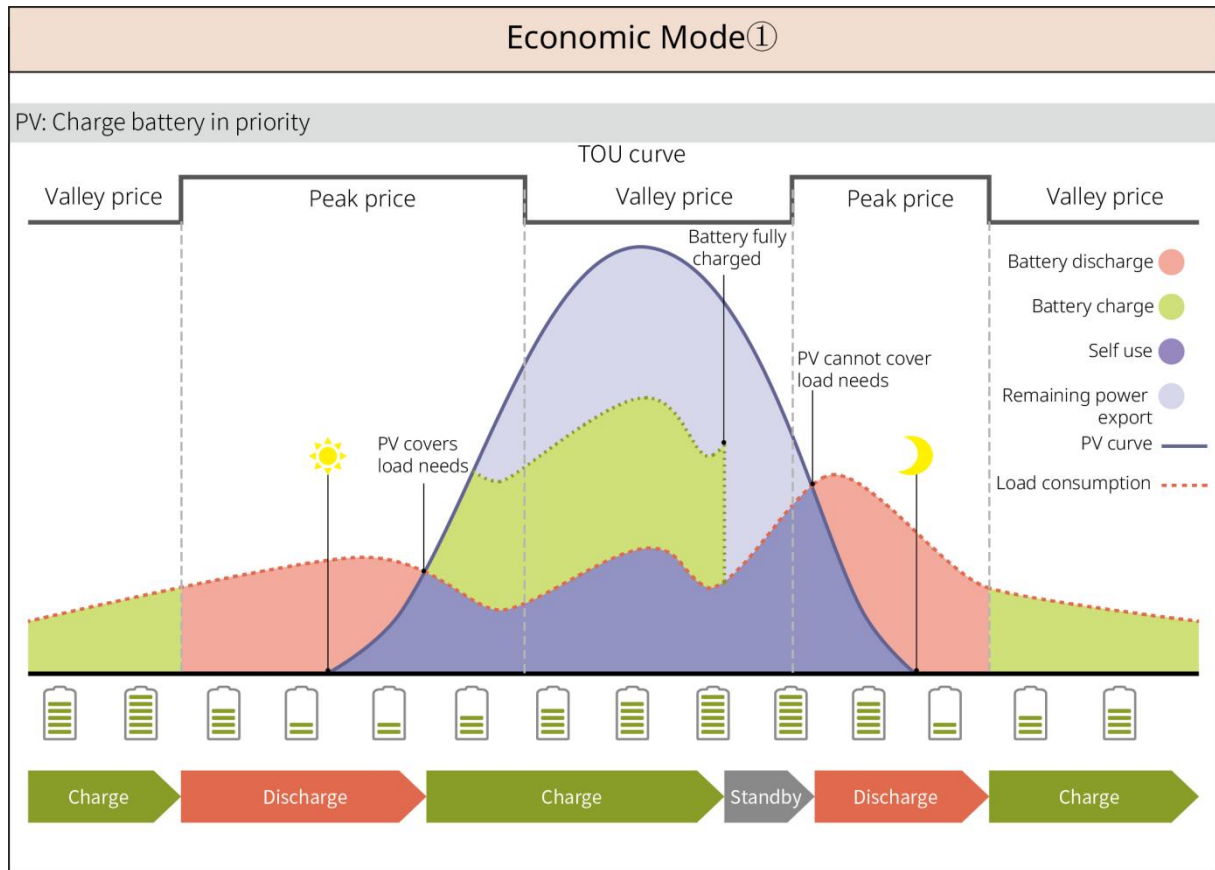

SLG00NET0004

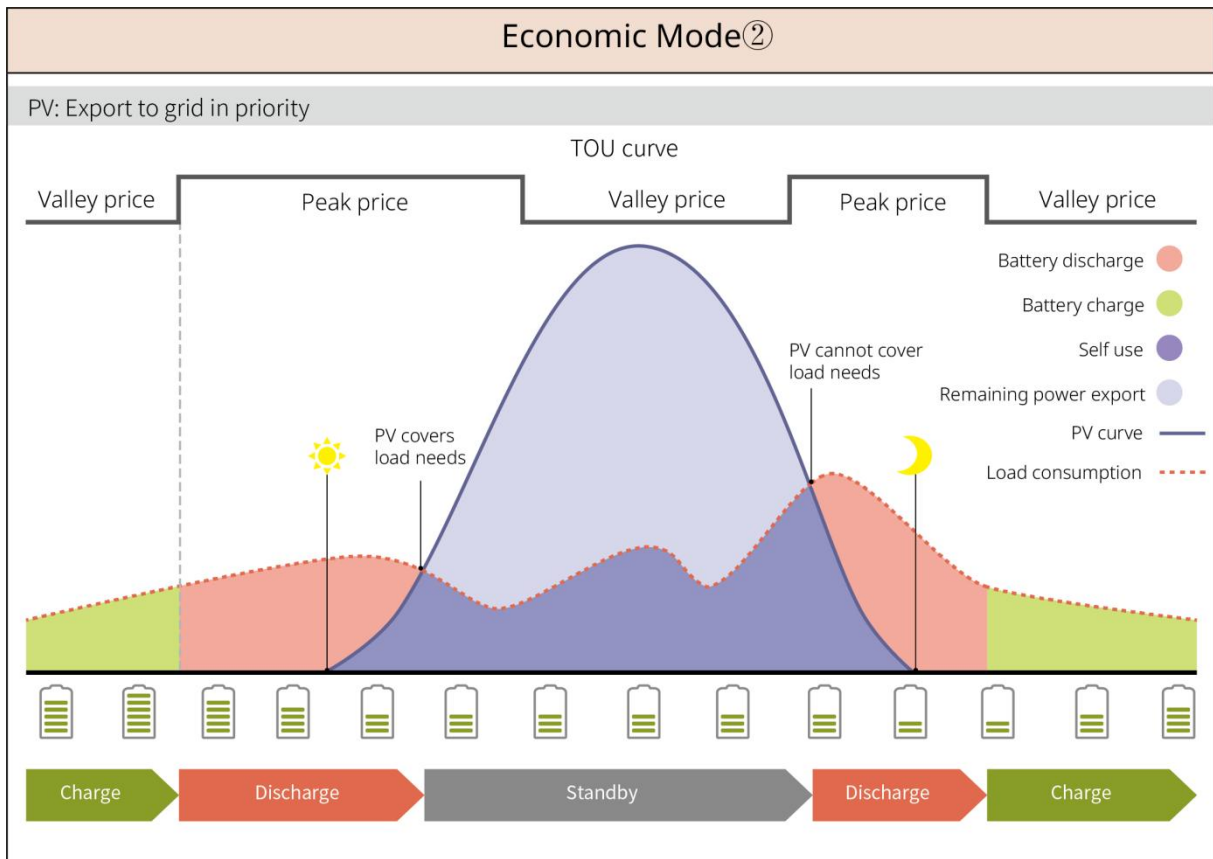

Smart charging

- In some countries/regions, the PV power feed into the utility grid is limited.
- Set peak limit power, charge the battery using the surplus power when the PV power exceeds the peak limit power. Or set charging time, during the charging time, the PV power can be used to charge the battery.

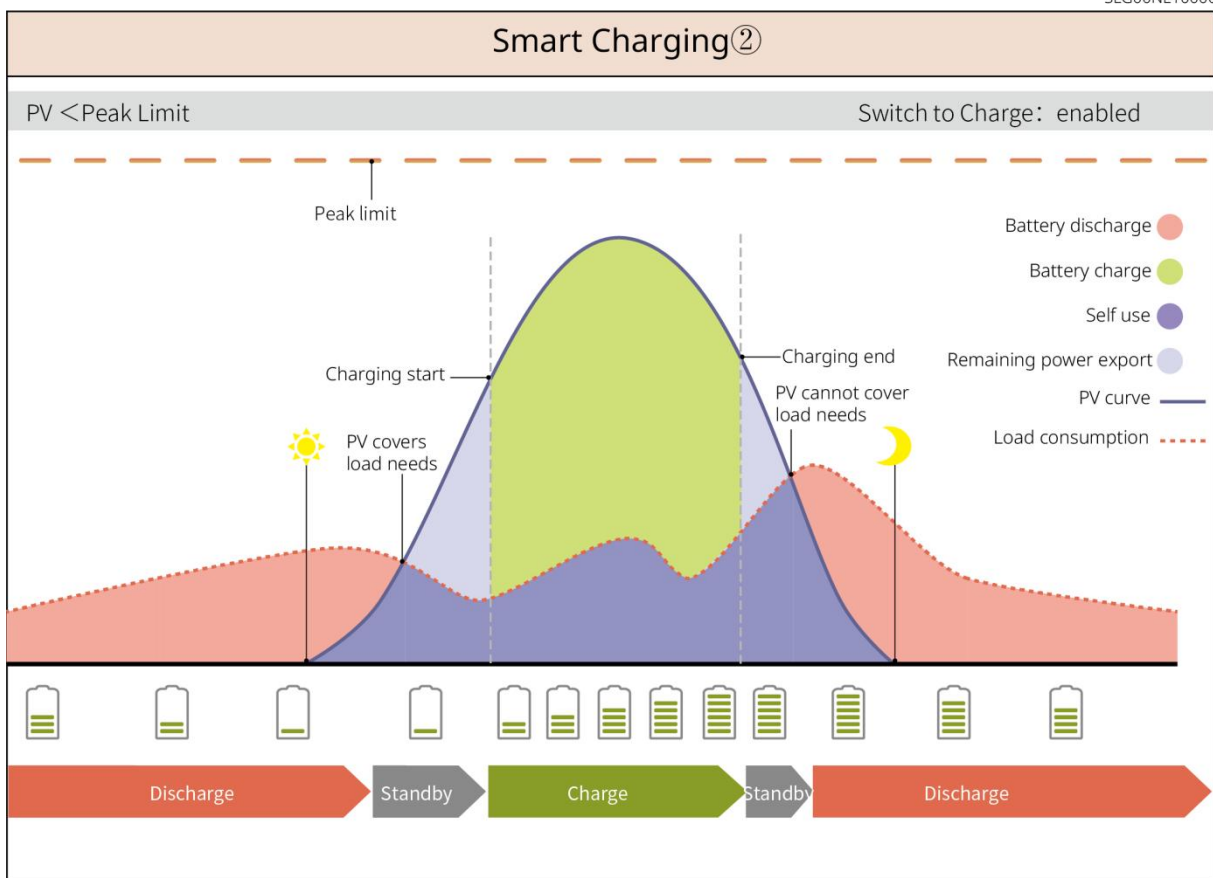
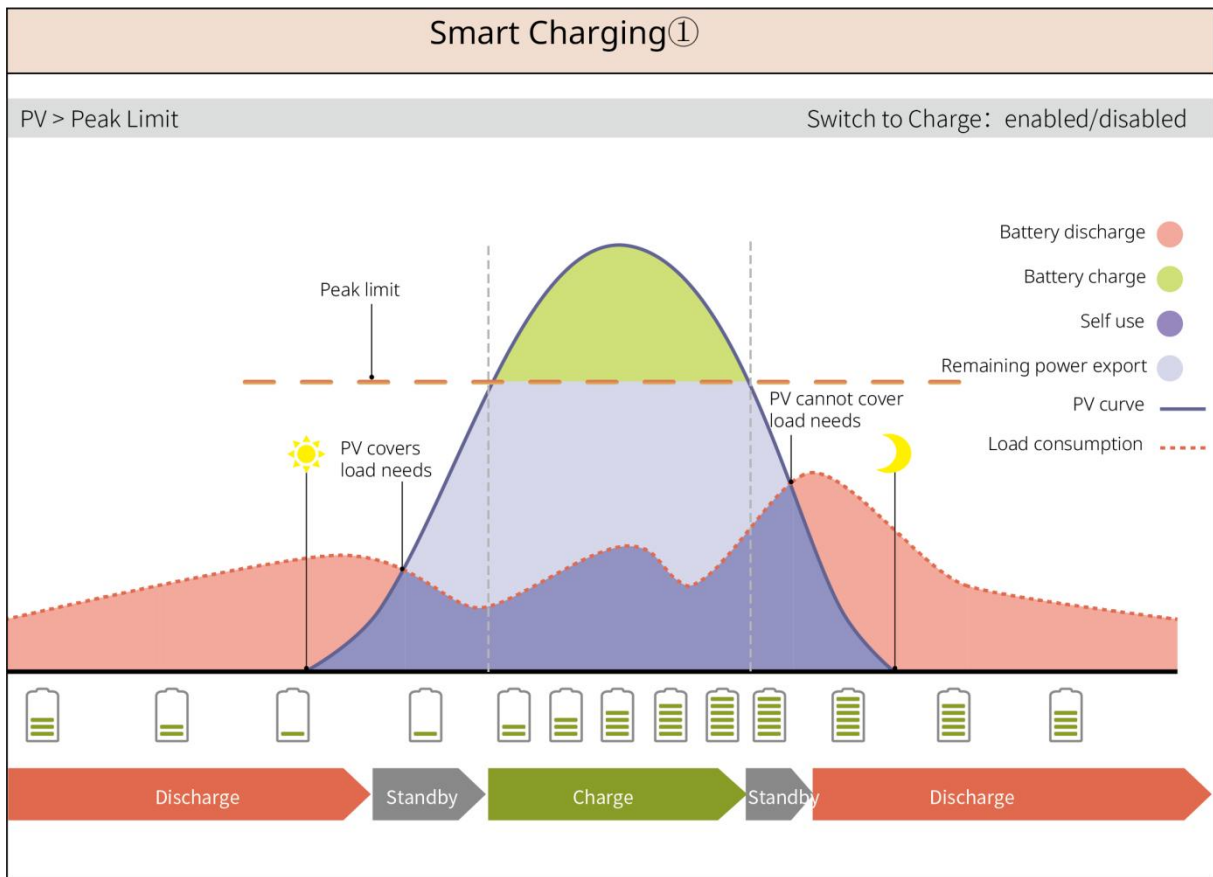

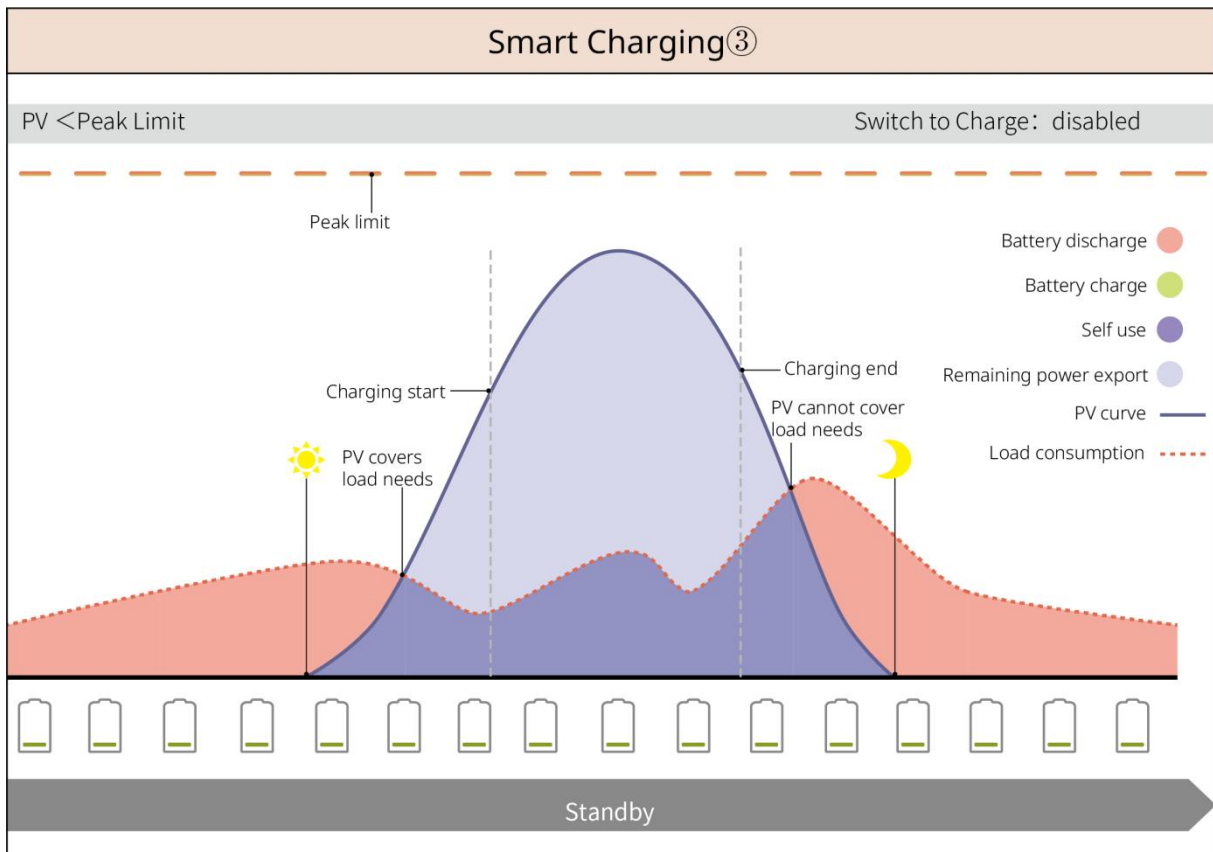

SLG00NET0008

Peakshaving mode

- Mainly suitable for commercial and industrial scenarios.
- When the total Load consumption Power exceeds the electricity quota in a short period, Battery discharge can be utilized to reduce the portion of electricity consumption that exceeds the quota.
- When the SOC of both Inverter circuits Battery is below the reserved SOC for Peakshaving, the system determines based on the time period, Load consumption quantity, and the peak power purchase limit buy power from the grid. When the SOC of only one Inverter circuit Battery is below the reserved SOC for Peakshaving, the system determines based on the Load consumption quantity and the peak power purchase limit buy power from the grid.

Peakshaving ①

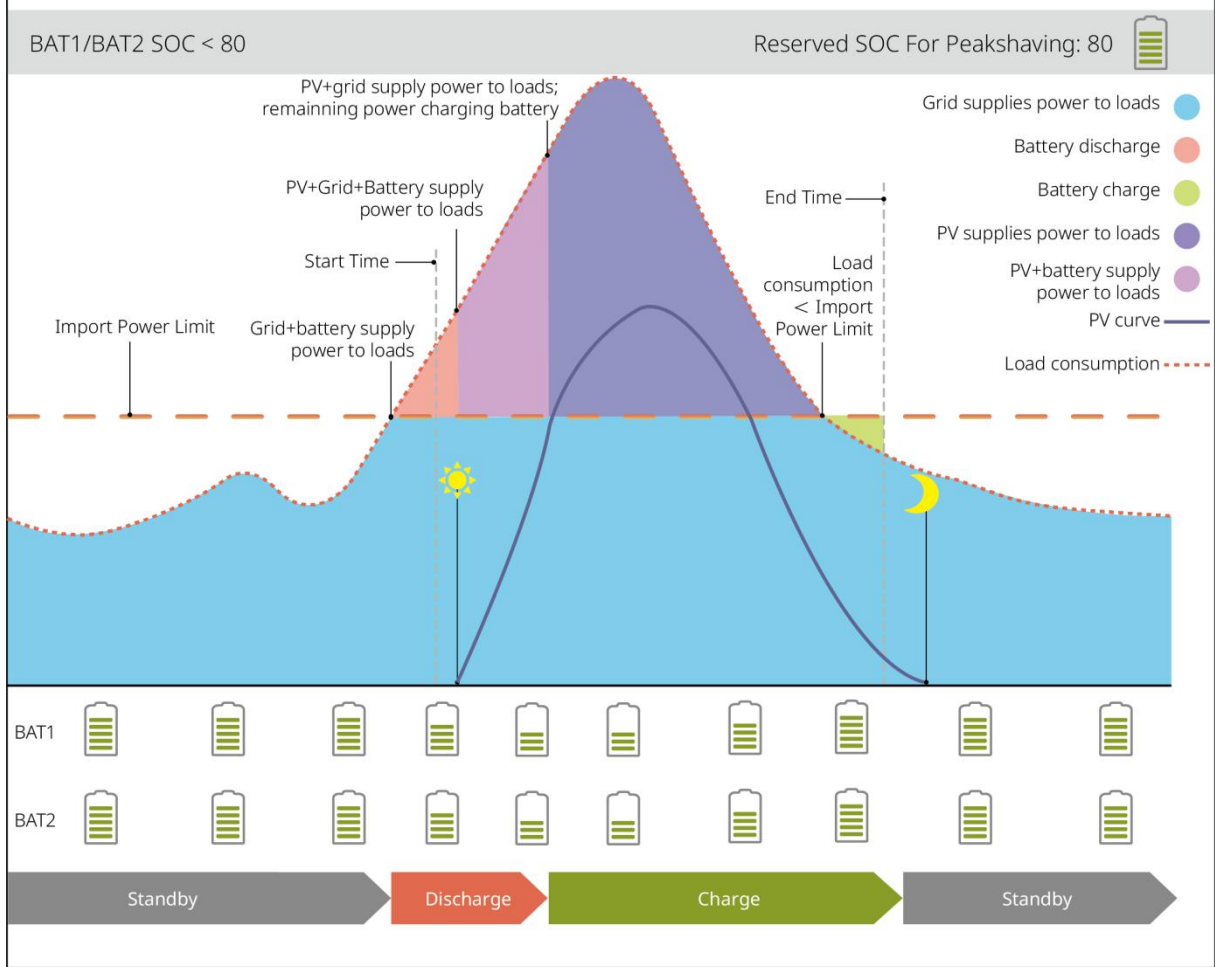

SLG00NET0010

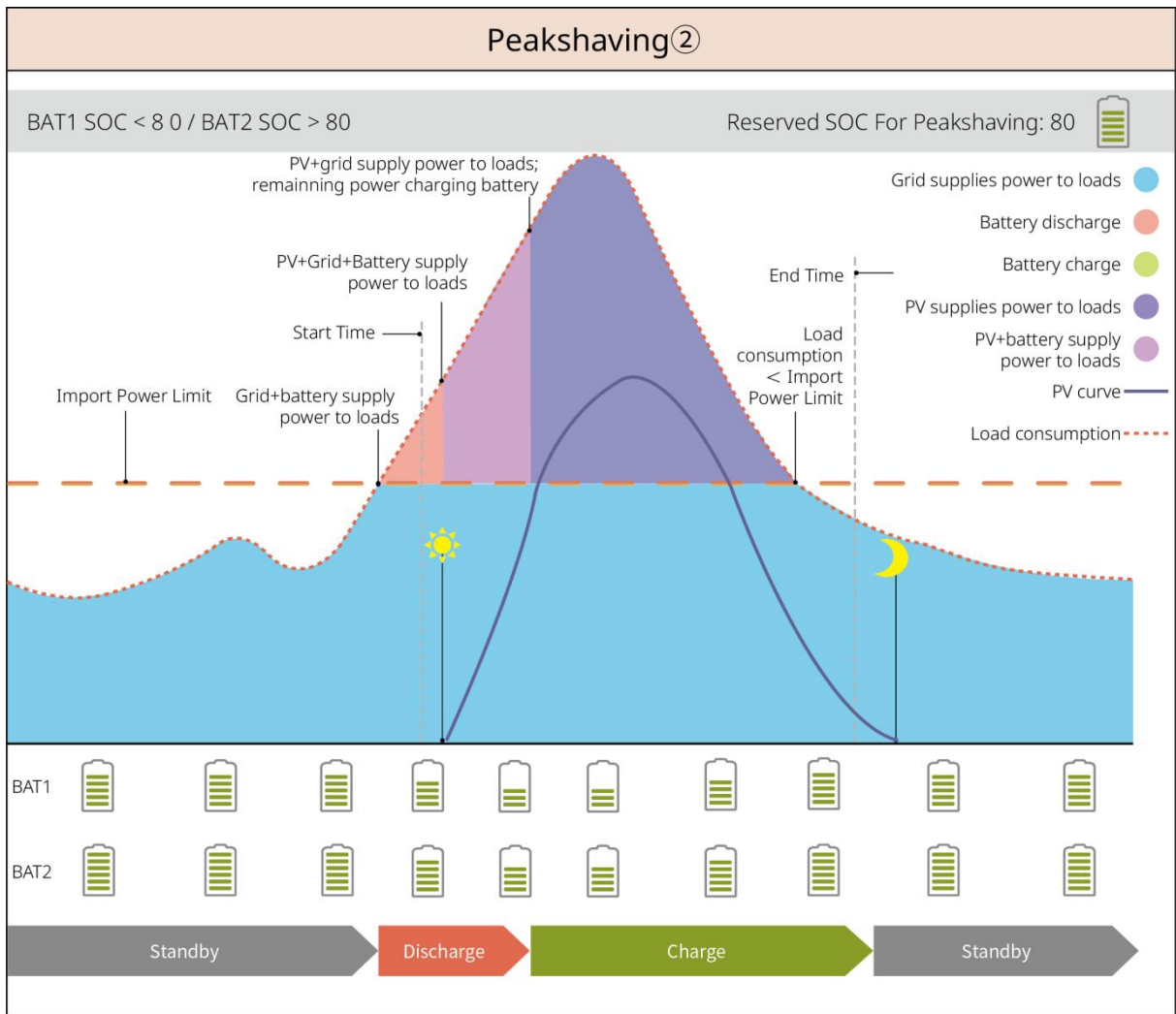

3.5 Features

Three-phase unbalanced output

Both the Inverter on-grid terminal and the BACK-UP terminal support three-phase unbalanced output, with each phase capable of connecting different Power loads. The maximum output Power per phase for different model is shown in the following table:

No.	model	Maximum output per phase Power
1	GW15K-ET	5kW
2	GW20K-ET	6.7kW
3	GW25K-ET	8.3kW
4	GW29.9K-ET	10kW
5	GW30K-ET	10kW

4 Check and Storage

4.1 Check Before Receiving

Before signing for the product, please carefully inspect the following:

1. Check the outer packaging for any damage, such as deformation, punctures, cracks, or other signs that may indicate potential harm to the equipment inside the box. If damage is found, do not open the packaging and contact your distributor.
2. Check the outer packaging of battery cabinet for any damage and inspect the circular indicator on the anti-tipping label. If it appears red, it indicates that the product was tipped during transportation. Do not open the packaging and contact your distributor immediately.
3. Check if the Inverter model is correct. If there is any discrepancy, do not open the package and contact your distributor.
4. After opening the box, check the anti-tipping label of the Battery on the inner front door and side wall. If the circular indicator is white, it indicates no abnormalities during transportation; if it is red, it means the Battery was tipped over during transit. Do not use this Battery and contact the after-sales service center for inspection and repair.

4.2 Package Content









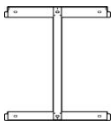
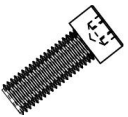
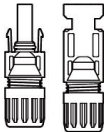

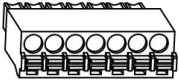
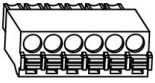
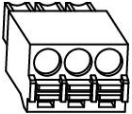
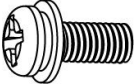
WARNING

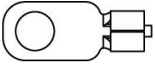
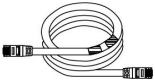
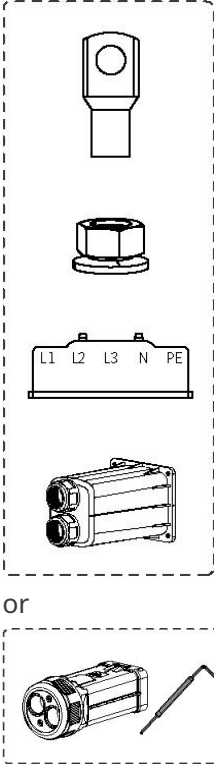
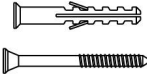
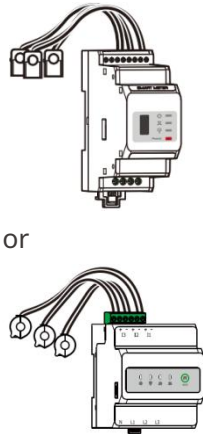
Check the deliverable for correct model, complete contents, and intact appearance. Contact the supplier as soon as possible if any damage is found.

4.2.1 Inverter Deliverables (ET 15-30kW)

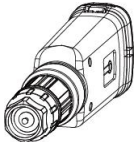

component	Quantity	Component	Quantity
	Inverter x 1		Backsheet x 1
	Rear-mounted fastening screw x 2		PV connector GW15K-ET、GW20K-ET: 4 GW25K-ET、GW29.9K-ET、 GW30K-ET: 6

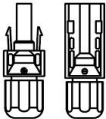
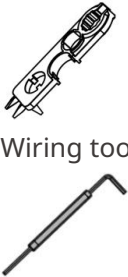
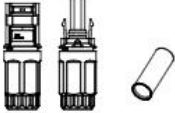







	PV Wiring tool x 1		7PIN communication terminal x 1
	6PIN communication terminal x 1		3PIN communication terminal x 1
	Protective PE screw x 1		PIN terminal x N The configuration varies, and the PIN terminal included with the box may differ. Please refer to the actual contents.
	Grounding terminal x 1		BMS/Meter GW15K-ET、GW20K-ET: 2 GW25K-ET、GW29.9K-ET、GW30K-ET: 3
 <p>Actual shipment shall prevail.</p> <ul style="list-style-type: none"> ● OT terminal x 12 ● AC terminal flange nut x 20 ● Insulation board for AC terminal x 1 ● AC terminal protective cover x 1 ● Internal Hexagon screwdriver x 1 			expansion bolt x 6
			Smart meter and accessories x 1 Subject to actual shipment.
	screwdriver x 1		smart dongle x 1
	Product Information x 1		smart dongle x 1







			
 Wiring tool  Battery connector	(Optional) Terminal tool x 1 Battery connector: GW15K-ET、GW20K-ET: 1 GW25K-ET、GW29.9K-ET、GW30K-ET: 2		
 Wiring tool Hexagon screwdriver  Battery connector	(Optional) Termination tool x 2 Hexagon screwdriver x 1 Battery connector: GW15K-ET、GW20K-ET: 1 GW25K-ET、GW29.9K-ET、GW30K-ET: 2		

4.2.2 Batteries Deliverables

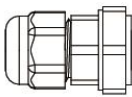
- **GW60KWH-D-10, GW60KWH-D-10 (Extension)**

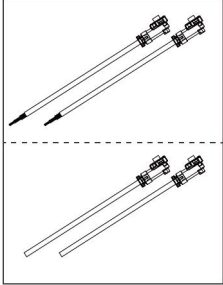
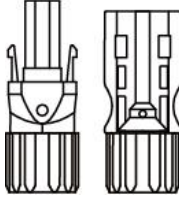
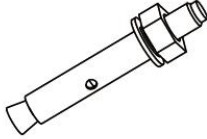
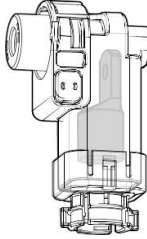
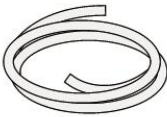

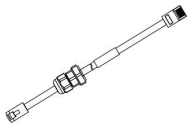

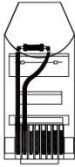



component	Quantity	component	Quantity
	Battery system x 1 GW60KWH-D-10: Including AC Cabin		Battery-Battery connecting aluminum busbar
	GW60KWH-D-10 (Extension): Excluding AC compartment		<ul style="list-style-type: none"> ● All aluminum busbars are shipped with accessories, with a quantity of 10 in the accessories. ● The aluminum busbar parts are shipped with the accessories, with a quantity of 3 in the accessories (other aluminum busbars have

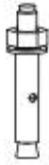



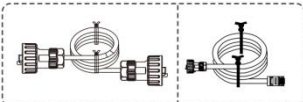
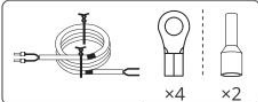

			already been Installation on the Battery).
	<p>Battery-High Voltage Box Connection Aluminum Busbar</p> <ul style="list-style-type: none"> ● Aluminum busbars are shipped with accessories, and the quantity in the accessories is 1. ● Aluminum busbar Installation is shipped on Battery with 0 accessories in the attachment. 		<p>Battery-High voltage box fixing screw x 2</p>
	<p>Battery-Battery fixed screw</p> <ul style="list-style-type: none"> ● All aluminum busbars are shipped with accessories, and the quantity of screw in the accessories is 22. ● The aluminum busbar parts are shipped with the accessories, and the quantity of the screw accessories is 6. 		<p>lifting eye x 4</p>
	<p>Inverter Backup wiring terminal x 5</p>		<p>M12 waterproof module x 2</p>
	<p>M18 waterproof module x 2</p>		<p>M20 waterproof module x 2</p>

	<p>M22 waterproof module x 4</p>		<p>cable tie x 10</p>
	<p>Inverter-High Voltage Box power cable GW60KWH-D-10 (Extension): 0 GW60KWH-D-10: 1</p>		<p>Inverter Battery wiring terminal GW60KWH-D-10 (Extension): 0 GW60KWH-D-10: N N: Refer to the actual shipment of the product.</p>
	<p>Expansion screw x 4</p>		<p>High Voltage Box Power Wiring terminal GW60KWH-D-10 (Extension): 2 GW60KWH-D-10: 1</p>
	<p>Air conditioning water pipe x 1</p>		<p>M5 x9</p>
	<p>Grounding terminal x 1</p>		<p>Inverter-High Voltage Box Communication cable GW60KWH-D-10: 1 GW60KWH-D-10 (Extension): 0</p>
	<p>Product Information x 1</p>		<p>Terminal resistor x 2 GW60KWH-D-10 (Extension): 1 GW60KWH-D-10: 0</p>

	<p>Wrench x 0: Fire Department has a "Do Not Touch" label.</p> <p>Wrench x 1: Others</p>	-	-
---	--	---	---



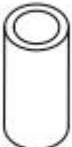

- **GW61.4-BAT-AC-G10, GW92.1-BAT-AC-G10, GW102.4-BAT-AC-G10, GW112.6-BAT-AC-G10**

component	Instructions	component	Instructions
	<p>battery cabinetx 1</p>		<p>Expansion screw x 4</p>
	<p>Grounding M5 screw x 3</p>		<p>Grounding terminal x 3</p>
	<p>Inverter Battery connection terminal 25mm² x 2</p>		<p>Interconnection between Battery with terminal 50mm² x 2</p>
	<p>Inter-pack series harness x N</p>		<p>Pack negative to high-voltage box negative harness x 1</p>
	<p>InverterBattery connection (positive) x 1</p>		<p>InverterBattery connection (Negative) x 1</p>
	<p>Battery and Inverter Communication network cable x 1</p>		<p>Air conditioning power harness x 1</p>

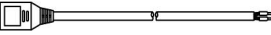
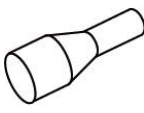

component	Instructions	component	Instructions
	lifting eye x 4		Cable tie x 20
	Air conditioning water pipe insulation x 1		fireproofing mud x 8
	Corrugated pipe connector x N*		25mm ² to 10mm ² Round tube terminal x N*
	Documents x 1		

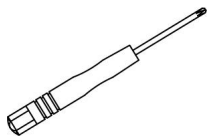
N: The quantity is subject to product configuration.

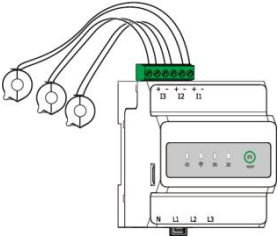
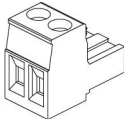
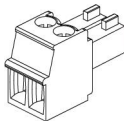
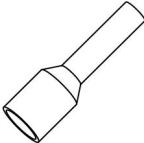
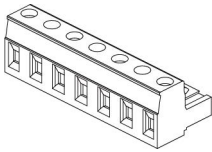
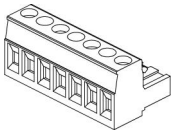
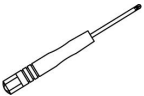
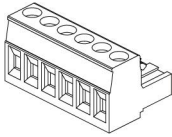

4.2.3 Smart Meter (GM3000)

Parts	Quantity	Parts	Quantity
	Smart meter and CT x 1		2PIN-RJ45 adapter cable x 1
	Tubular terminal x 3		USB plug x 1
	Screws driver x 1		Documents x 1

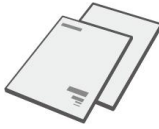
4.2.4 Smart Meter (GM330&GMK330)

Parts	Description	Parts	Description
	<ul style="list-style-type: none"> Smart meter x 1 CT x N^[1] <p>[1] GMK330: CT x 3; GM330: CT can be self-provided or purchased by contacting GoodWe.</p>	 Or 	2PIN terminal x 1
	Tubular terminal x N <ul style="list-style-type: none"> GM330 x 6 GMK330 x 5 	 Or 	7PIN terminal x 1
	Screw driver x 1		6PIN terminal x 1 Only applicable to GM330
	2PIN-RJ45 adapter cable x 1		Documents x 1

4.2.5 Smart Dongle (Wi-Fi Kit)

Parts	Description	Parts	Description
	Smart dongle x 1		Documents x 1
	Unlock tool x 1 Remove the module using the removing tool if it is included. If the tool is not		

provided, remove the module by pressing the unlock button on the module.

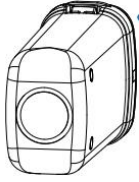

4.2.6 Smart Dongle (LS4G Kit-CN&4G Kit-CN)

Parts	Description	Parts	Description
	4Gsmart dongle x1	-	-

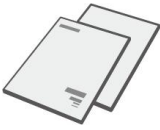

4.2.7 Smart Dongle (WiFi/ LAN Kit-20)

Parts	Description	Parts	Description
	Smart dongle x 1		Documents x 1

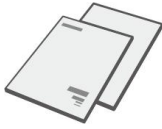
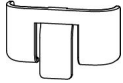
4.2.8 Smart Dongle (Ezlink3000)

Parts	Description	Parts	Description
	Smart dongle x 1		LAN cable connector x 1
	Documents x 1		Unlock tool x 1 Remove the module using the removing tool if it is included. If the tool is not provided, remove the module by pressing the unlock button on the module.

4.2.9 Smart Dongle (4G Kit-CN-G20 & 4G Kit-CN-G21)

Parts	Description	Parts	Description
	smart dongle x 1		Documents x 1

4.3 Storage

If the equipment is not put into use immediately, please store it according to the following requirements. After long-term storage, the equipment must be inspected and confirmed by professionals before it can be used again.

1. If the storage time of Inverter exceeds two years or the non-operational time after Installation exceeds six months, it is recommended to undergo inspection and testing by professionals before being put into use.
2. To ensure the good electrical performance of the electronic components inside the Inverter, it is recommended to power it on every 6 months during storage. If it has not been powered on for more than 6 months, professional inspection and testing are recommended before putting it into operation.
3. To ensure the performance and service life of Battery, it is recommended to avoid prolonged idle storage. Extended storage may lead to deep Discharge of the Battery, causing irreversible chemical degradation, capacity decay, or even complete failure. Timely usage is advised. If Battery requires long-term storage, please follow the maintenance requirements below:

Specific Model	Battery storage initial SOC range	Recommended Storage Temperature	Charing and Discharging Maintaining Period ^[1]	Battery Maintaining Method ^[2]
GW60KWH-D-10 GW60KWH-D-10 (Extension)	30%~40%	0~35°C	-20~0°C, ≤1 month 0~+35°C, ≤6 months 35~+45°C, ≤1months	Contact the dealer or the after-sales service for maintenance methods.
GW61.4-BAT-AC-G10 GW92.1-BAT-AC-G10 GW102.4-BAT-AC-G10 GW112.6-BAT-AC-G10	30%~40%	0~35°C	-20~35°C (≤12 months) 35~+45°C (≤6 months)	

NOTICE

[1] The storage time is calculated from the SN date on the Battery outer packaging. After exceeding the storage cycle, Discharge charging maintenance is required. (Battery Maintenance time = SN date + Discharge charging maintenance cycle). For the method to view the SN date, refer to: [SN code meaning](#).

[2] After the charging maintenance is qualified, if there is a Maintaining Label on the outer box, please update the maintenance information on the Maintaining Label. If there is no Maintaining Label, please record the maintenance time and battery SOC by yourself and keep the data properly for easy maintenance record storage.

Packaging requirements:

1. Ensure the outer packaging box is not dismantle, and the desiccant inside is not missing.
2. It is recommended to complete the Installation of the equipment within 3 days after unpacking the dismantle packaging box dismantle. If the equipment is not Installation, it should be repackaged using the original packaging box for storage.

Environmental requirements:

1. Ensure the Storage is placed in a shaded area and avoid direct sunlight.
2. Ensure the storage environment is clean, with an appropriate temperature range and no condensation. If condensation is observed on the equipment surface, do not power on the device. Recommended storage humidity range: 30%-80%.
3. Ensure that Storage is kept away from flammable, explosive, and corrosive materials.

stack requirements:

1. Ensure the Inverter stack height and orientation are positioned according to the instructions on the packaging label.
2. Ensure there is no risk of tipping after Inverterstack.

5 Installation



Install and connect the equipment using the deliverable included in the package. Otherwise, the manufacturer shall not be liable for the damage.

5.1 System Installation and Commissioning Procedure

Steps	1 Installation		2 PE		3 Battery				4 COM	
Battery	Battery A	Battery B	Battery A	Battery B	Battery A	Battery B	Battery A	Battery B	Battery A	Battery B
Tools	1 D: 80mm d: 14mm 2 M12 50N·m		M5 4.5N·m	M5 4N·m	1 M6 6N·m 2 M8 10N·m Recommend: YQK-70 3 M5 4.5-6N·m	Crimping tool				
Steps	1 Installation	2 PE	3 PV	4 Battery	5 AC	6 COM	7 Communication module			
Inverter							Wi-Fi Kit	WiFi/LAN Kit-20	Ezlink3000	
Tools	1 M5 4.5N·m 2 M5 1.2-2N·m	M5 1.2-2N·m	Recommend: PV-CZM-61100	Recommend: VXC9	1 M5 2-3N·m 2 M6 3-4N·m	M4 1.5N·m	4G Kit-CN LS4G Kit-CN 4G Kit-CN-G20 4G Kit-CN-G21			
Steps	1 Installation		2 Cable Connections		3 Power	4 Commissioning				
Smart meter	GM3000	GM330/GMK330	GM3000	GMK330	GM330	AC breaker	SolarGo APP SEMS Portal APP or SEMS Portal WEB			

Note:

- **Battery A:** GW60KWH-D-10, GW60KWH-D-10 (Extension)
- **Battery B:** GW61.4-BAT-AC-G10, GW92.1-BAT-AC-G10, GW102.4-BAT-AC-G10, GW112.6-BAT-AC-G10

5.2 Installation Requirements

5.2.1 Installation Environment Requirements

1. Do not install the equipment in a place near flammable, explosive, corrosive, or toxic materials.
2. The temperature and humidity at the installation site should be within the appropriate range.
3. keep away from children.
4. The surface temperature of the inverter can be high during operation. Do not touch the surface before it cools down to avoid burns.
5. The equipment should be protected from direct sunlight, rain, and snow.
6. The inverter output power may decrease due to direct sunlight or high temperature.

7. The place to install the equipment shall be well-ventilated for heat radiation and large enough for operations.
8. Check the protection rating of the equipment and ensure that the installation environment meets the requirements. The inverter, battery system, and smart dongle can be installed both indoors or outdoors. But the smart meter can only be installed indoors.
9. Ensure that there are no obstacles within a 10m diameter around the installation location when installing the equipment indoors.
10. Ensure that the equipment bottom is above the local historical highest water level.
11. Install the equipment at a height that is convenient for operation and maintenance, electrical connections, and checking indicators and labels.
12. The altitude to install the equipment shall be lower than the maximum working altitude of the system.
13. Consult the manufacturer before installing the equipment outdoors in salt affected areas. A salt affected area refers to the region within 500 meters offshore, and will be related to the sea wind, precipitation and topography.
14. Install the equipment away from electromagnetic interference. If there is any radio or wireless communication equipment below 30MHz near the equipment, you have to:
 - Inverter: add a multi-turn winding ferrite core at the AC output cable of the inverter, or add a low-pass EMI filter.
 - Other equipment: the distance between the equipment and the wireless EMI equipment should be more than 30m.
15. The DC and communication cables between the battery and inverter should be less than 3 meters. Please ensure that the installation distance between the inverter and the battery meets the cable length requirements.

NOTICE

If installed in an environment below 0°C, the battery will not be able to continue charging to restore energy after being discharged, resulting in undervoltage protection.
GW60KWH-D-10 : Charging temperature range : $0 < T < 55^{\circ}\text{C}$; Discharging temperature range : $-25 < T < 55^{\circ}\text{C}$

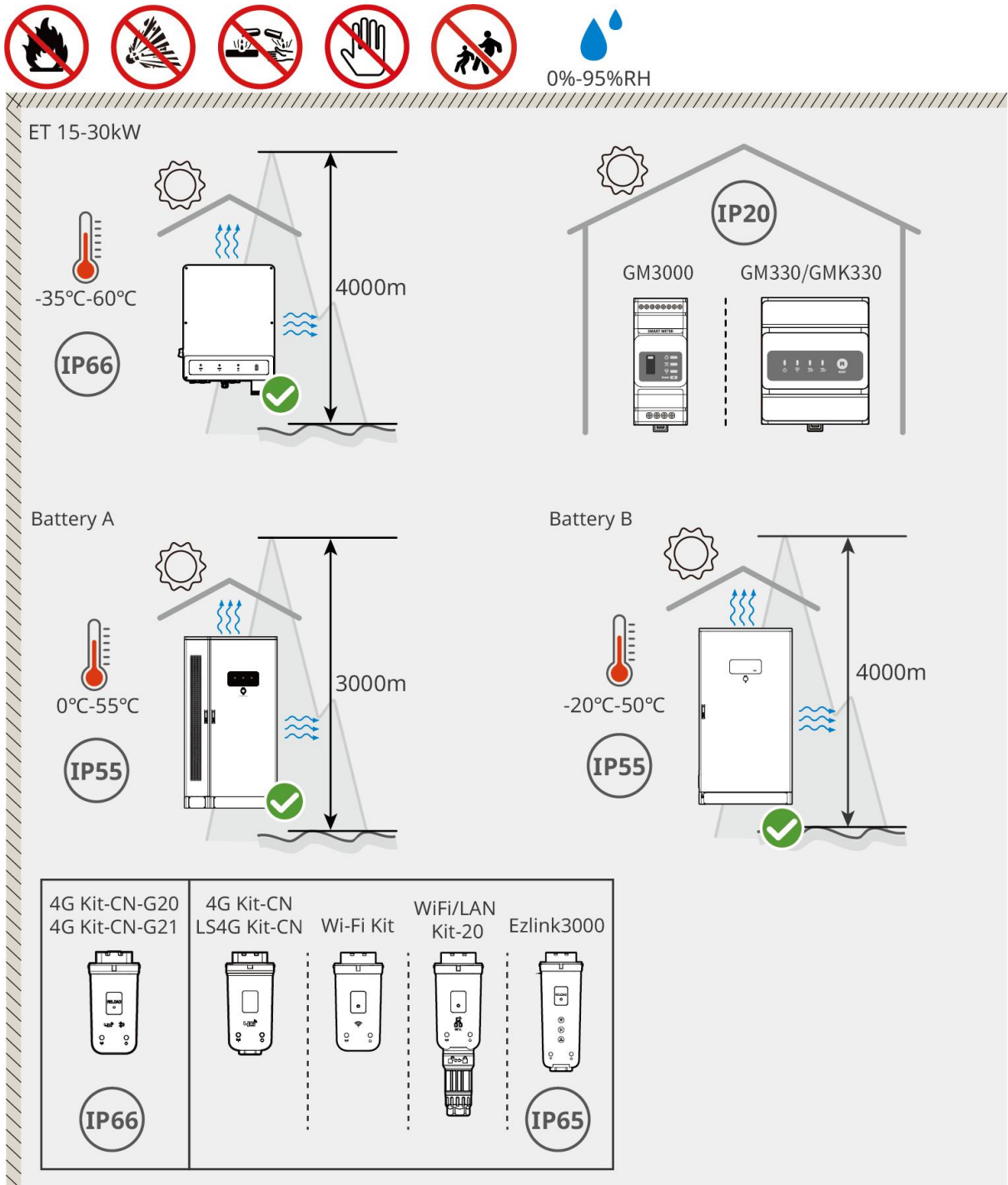

ET3010INT0007

5.2.2 Foundation Requirements

- The installation foundation must be level, dry, and free from depressions or tilts. Do not install in areas with standing water.
- Ensure the ground is level and stable, capable of bearing the weight of the energy storage system.
- The foundation material must be concrete or other non-combustible surface.
- Reserved cable trenches or holes for wiring in the foundation.

- The equipment installation should be adjusted according to the site conditions, including heights, embedded expansion bolts, conduits, etc.
- The top height of the foundation can be adjusted based on the equipment and site requirements.
- Cable trench requirements:
 1. The cables are routed from the bottom of the equipment. The cable trench must be designed with dust and rodent protection to prevent foreign objects from entering.
 2. The cable trench must be waterproof and moisture-proof to prevent cable aging and short circuit, which could affect normal operation of the equipment.
 3. As the cables are thick, the cable trench should reserve sufficient space to ensure smooth connections without abrasion.

NOTICE

The conduit can be replaced with four PVC pipes with a diameter of 125mm, if required by the site. Conduit is not needed for indoor environments.

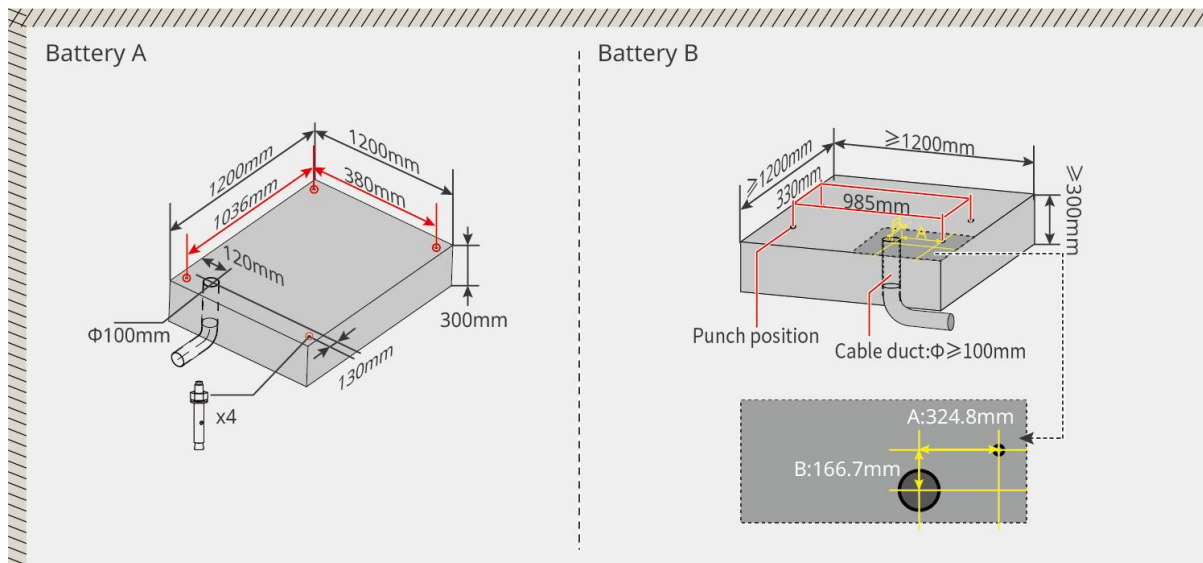

LXC6010INT0001

5.2.3 Installation Space Requirements

Reserve enough space for operations and heat dissipation when installing the system.

NOTICE

The specific value of the battery installation space requirement can be adjusted based on the actual installation scenario and local regulations.

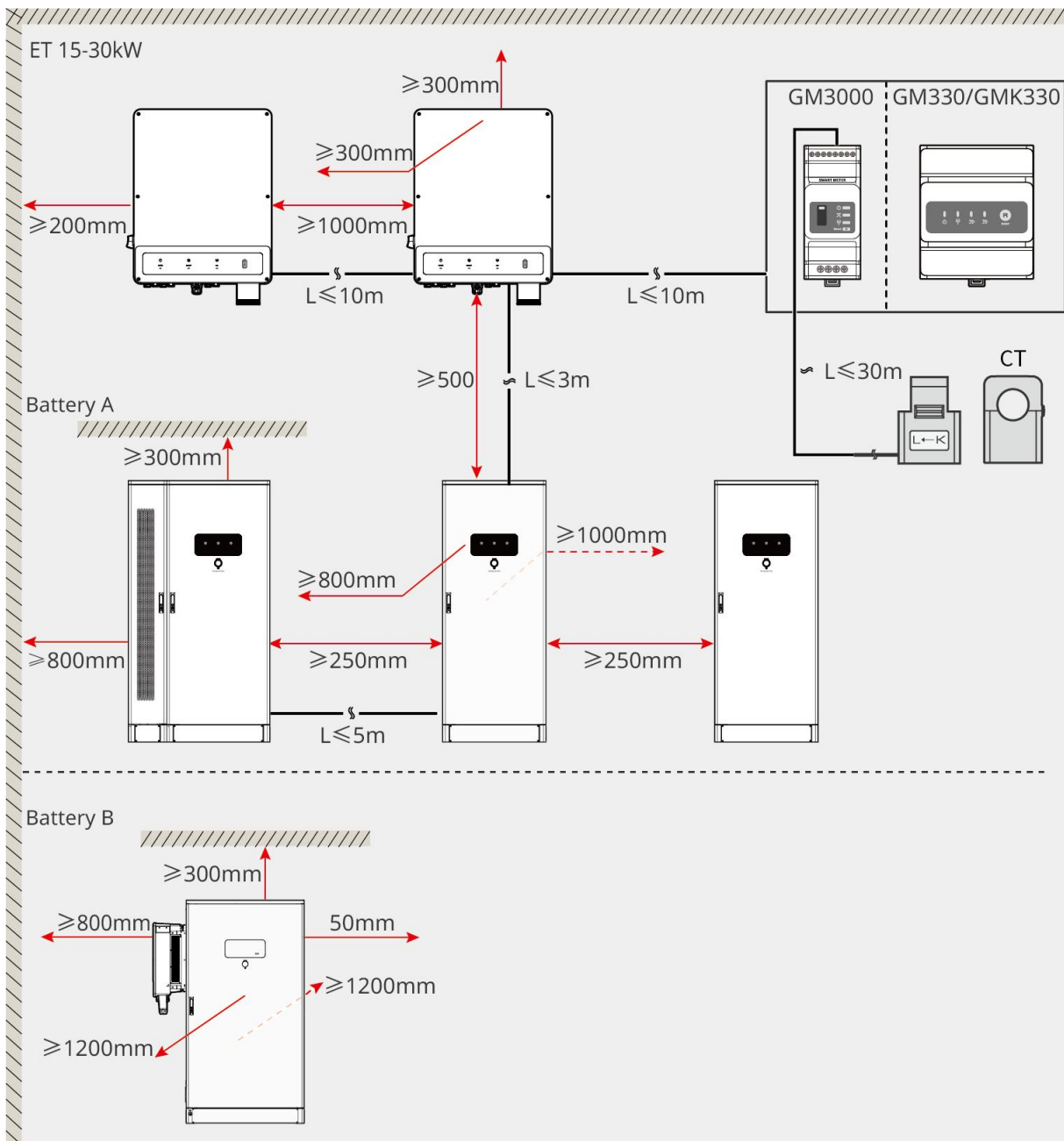

ET3010INT0008

Note:







- **Battery A:** GW60KWH-D-10, GW60KWH-D-10 (Extension)
- **Battery B:** GW61.4-BAT-AC-G10, GW92.1-BAT-AC-G10, GW102.4-BAT-AC-G10, GW112.6-BAT-AC-G10

5.2.4 Tool Requirements

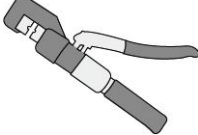

NOTICE

The following tools are recommended when installing the equipment. Use other auxiliary tools on site if necessary.

Installation Tools

Tool Type	Description	Tool Type	Description
	Diagonal pliers		RJ45 crimping tool
	Wire stripper		YQK-70 hydraulic pliers
	Adjustable wrench		PV connector tool PV-CZM-61100
	Hammer drill (Φ8mm)		Torque wrench M5/M6/M8/M12/M16/M18/ M22
	Rubber hammer		Socket wrench set
	Marker		Multimeter Range ≤ 1100V
	Heat shrink tube		Heat gun
	Cable tie		Vacuum cleaner
	Level	-	-

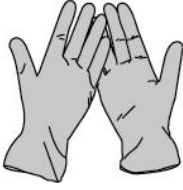
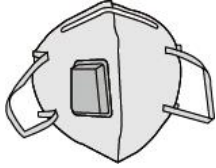
Personal Protective Equipment

Tool Type	Description	Tool Type	Description
	Insulation gloves and safety gloves		Dust mask
	Goggles		Safety shoes

5.2.5 Transportation Requirements

WARNING

- During transportation, handling, and Installation operations, it is necessary to comply with the laws, regulations, and relevant standards of the country or region where the operations are conducted.
- Before Installation, it is necessary to move Equipment Handling to the Installation location. To prevent personal injury or equipment damage during the handling process, please NOTICE the following matters:
 1. Please equip the corresponding personnel according to the device Weight to prevent the equipment from exceeding the human body's Weight handling range and causing injury to personnel.
 2. Please wear safety gloves to avoid injury.
 3. Please ensure the equipment is kept balanced during handling to avoid dropping and tipping over.
 4. During transportation, ensure that the cabinet doors are securely locked.

NOTICE

- The equipment can be transported to the Installation location by hoisting or forklift.
- When lifting and moving equipment using a hoisting method, please use flexible slings or straps, with a single strap load-bearing capacity of $\geq 2t$.
- When using forklift handling equipment, the forklift load-bearing capacity must be $\geq 2t$.

- **GW60KWH-D-10, GW60KWH-D-10 (Extension)**

Forklift transportation method I

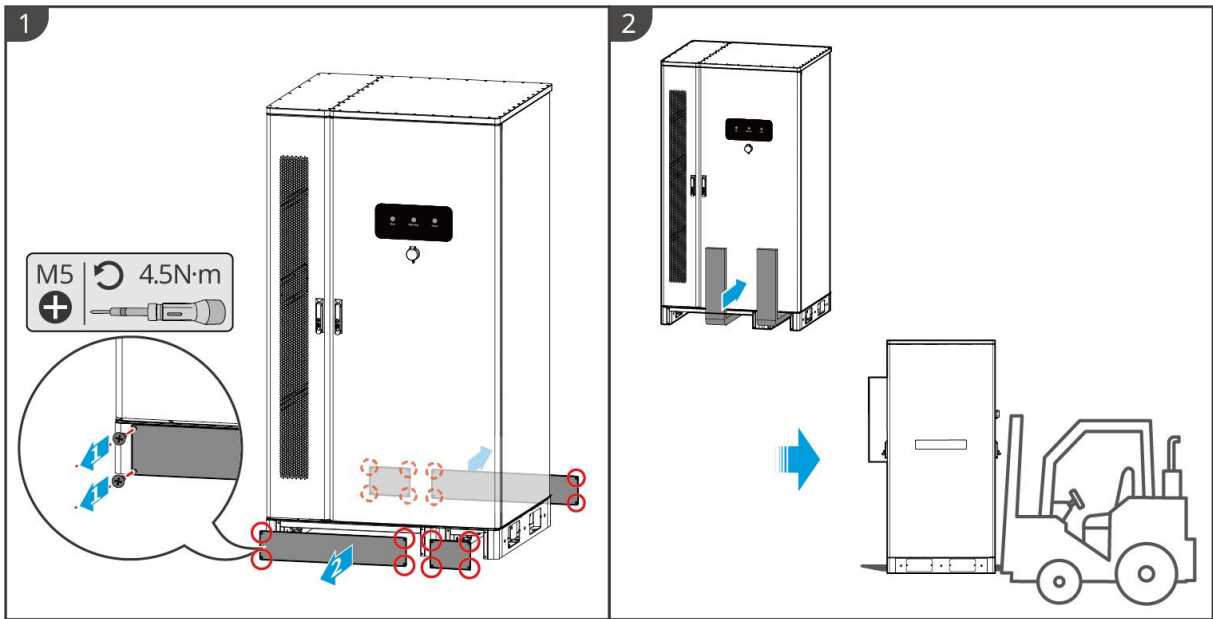

LXC6010INT002

Forklift transportation method II

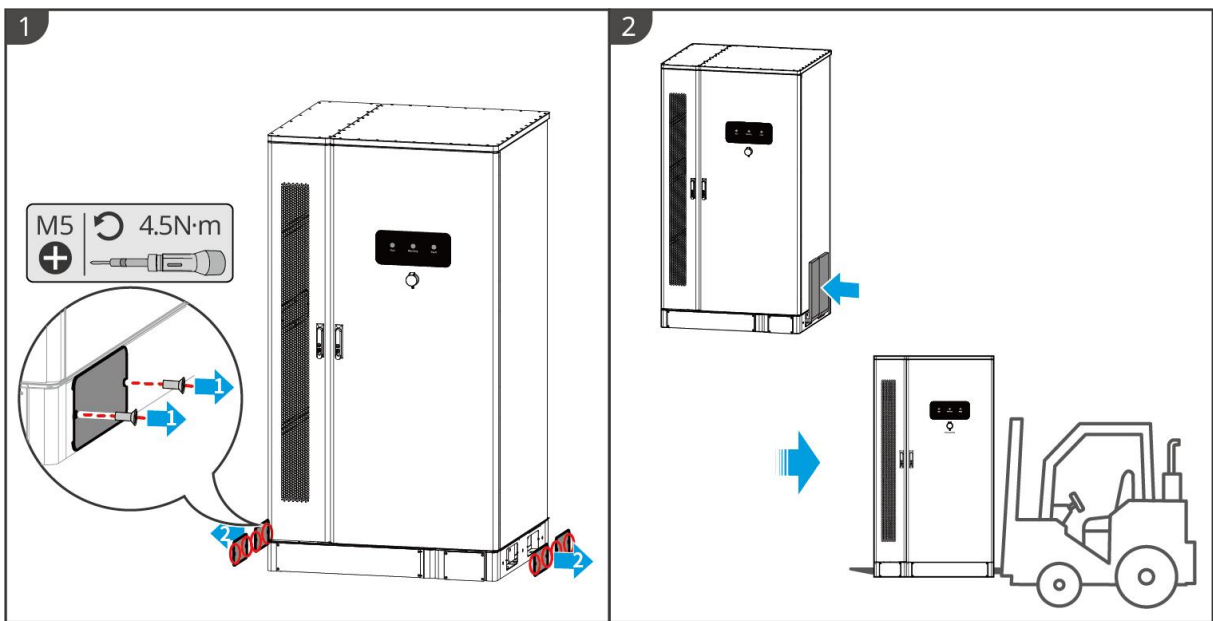

LXC6010INT003

Hoist transportation

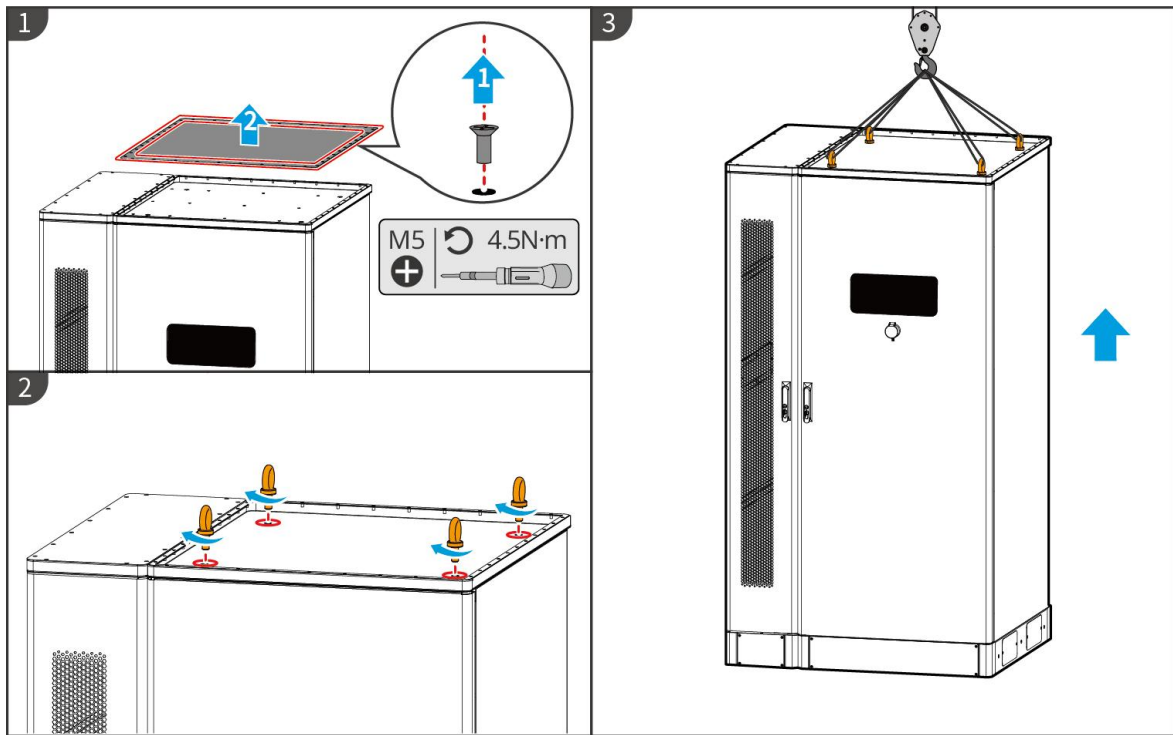

LXC6010INT0004

- **GW61.4-BAT-AC-G10, GW92.1-BAT-AC-G10, GW102.4-BAT-AC-G10, GW112.6-BAT-AC-G10**

NOTICE

- Remove the front panels before using a forklift to handle the batteries.
- The battery system is fastened to the skid plate with bottom screws when shipped. Remove the skid plate first before installation.

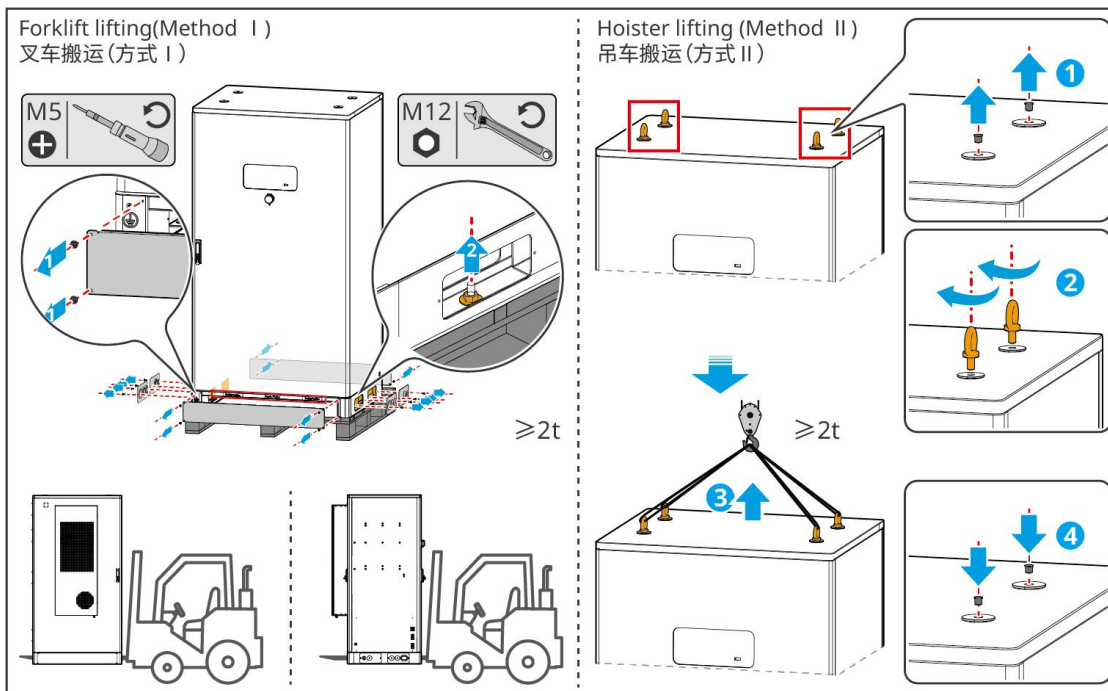

BAT10INT0003

5.3 Installing the Battery System



WARNING

- Check and ensure that the ground is level and has no slope before installation.
- Ensure that the energy storage system is vertically cling to the ground without risk of tipping.

5.3.1 Installing GW60KWH-D-10、 GW60KWH-D-10(Extension)

Step 1 Mark the drilling position on the level ground.

Step 2 Drill the holes to a depth of 80mm using a drill with a 14mm drill bit, and install the expansion bolts.

Step 3 Transport the energy storage system to the marked position, and tighten the expansion bolts using a socket wrench.

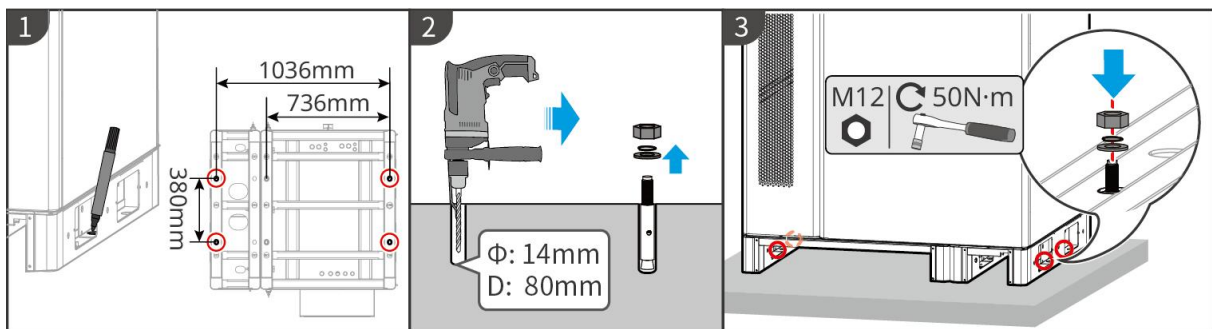

LXC6010INT005



WARNING

- Do not open the cabinet door during transportation or installation.
- Close the cabinet door after system installation, wiring and commissioning.

Step 1 Unlock the cabinet door with the key.

Step 2 Rotate the door handle to open the cabinet door.

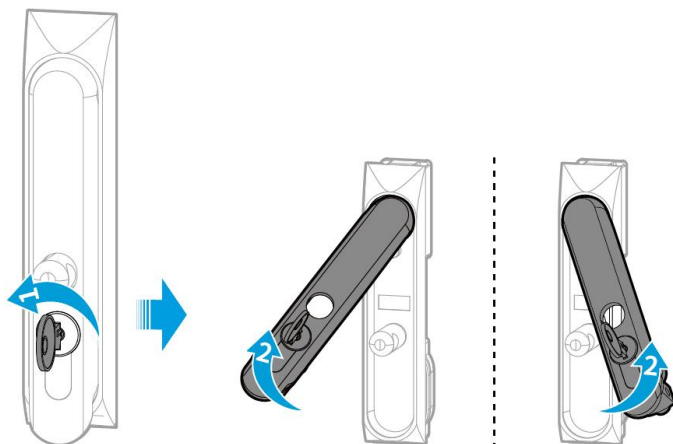

LXC6010INT0006

5.3.2 Installing GW61.4-BAT-AC-G10, GW92.1-BAT-AC-G10, GW102.4-BAT-AC-G10, GW112.6-BAT-AC-G10

Remove the the protecting cover of temperature alarm and smoke alarm

When the batteries are shipped, smoke alarms and temperature alarms are equipped with protective covers. The protective covers need to be removed for the alarms to work properly.

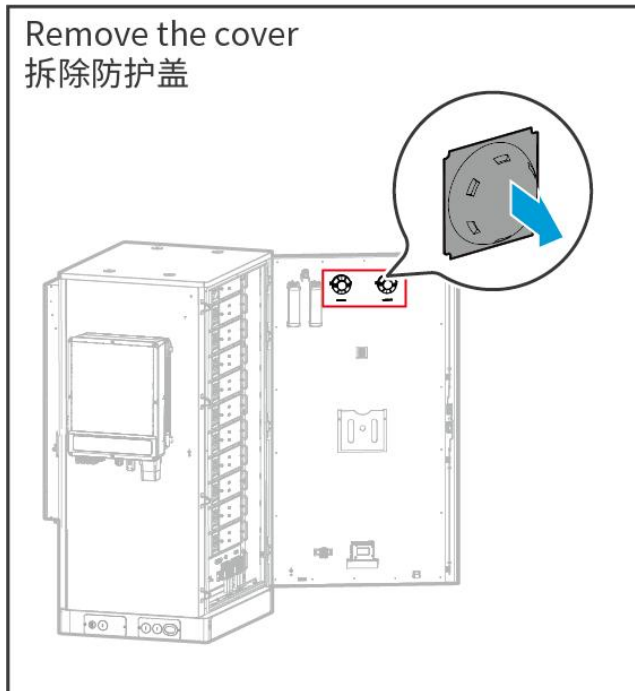

BAT10INT0016

Secure the battery system to the foundation

Step 1: Mark the drilling positions according to the dimensions shown in the diagram.

Step 2: Use an impact drill to drill holes and install expansion bolts.

Step 3: Move the battery rack to the hole positions and secure the batteries to the foundation with expansion bolts.

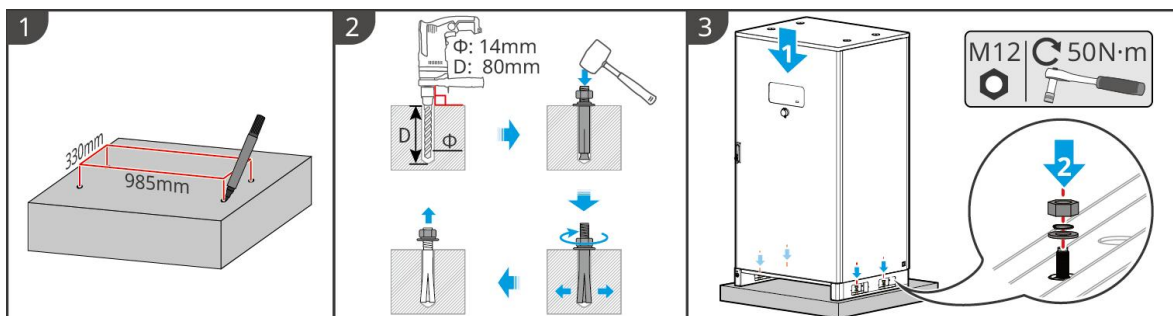

BAT10INT0005

Install the air conditioner drain pipe

Step 1: Install the drain pipe joint.

Step 2: Tighten the fixing screws of the air conditioner drain pipe and connect the drain pipe to the drainage system.

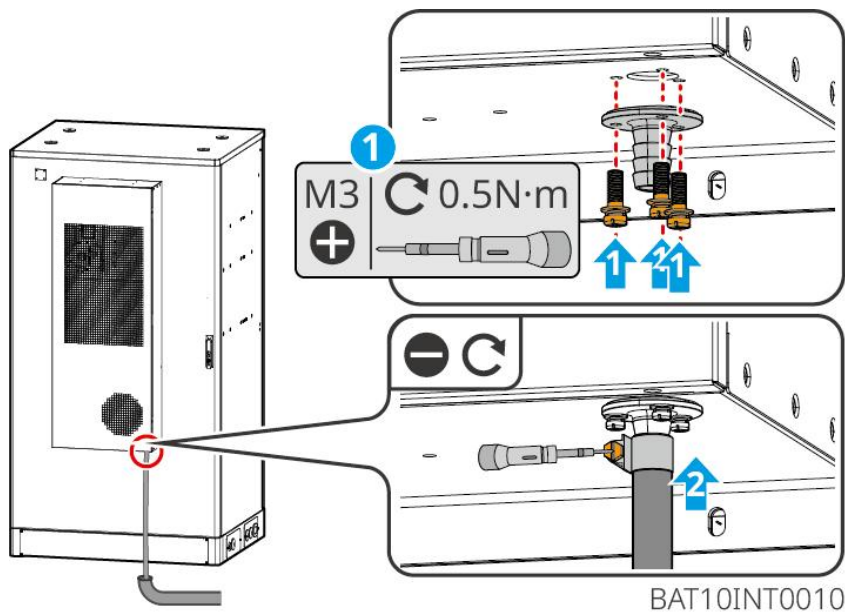

5.4 Installing the Inverter

Inverter Installation in the Battery system cabinet



CAUTION

Ensure the Inverter Installation is securely fastened to prevent falling and injuring personnel.

Step 1 Secure the Inverter mounting plate bracket onto the Battery system cabinet.

Step 2 (Optional) Use a DC switch lock to secure the DC switch in the "OFF" position and mount the Inverter onto the backplate. The DC switch lock is to be provided by the user; ensure that the aperture of the DC switch lock meets the requirements.

Step 3 Tighten the screw on both sides to secure the backsheet and Inverter, ensuring the Inverter Installation is stable.

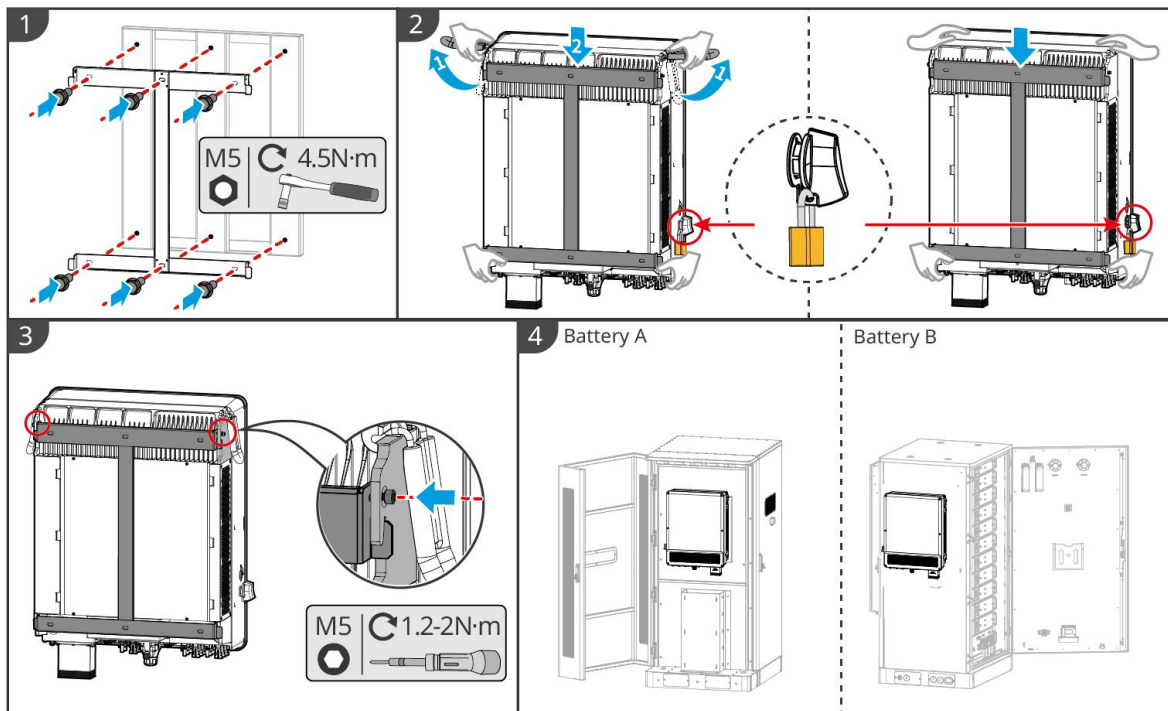

ET3010INT0006

Inverter Installation on the wall



- When drilling, ensure the hole location avoids water pipes, cables, etc. inside the wall to prevent DANGER.
- When punching holes, wear goggle and a dust mask to prevent dust from inhalation entering the respiratory tract or falling into the eyes.
- Ensure the Inverter Installation is securely fastened to prevent falling and injuring personnel.

Step 1 Place the mounting plate horizontally on the wall surface and mark the drilling positions with a marker pen.

Step 2 Use hammer drill for punching.

Step 3 Secure the Inverter mounting plate bracket to the wall using expansion bolt.

Step 4 (Optional) Use a DC switch lock to secure the DC switch in the "OFF" position and mount the Inverter on the backplate. The DC switch lock is user-supplied; please ensure the aperture of the DC switch lock meets the requirements.

Step 5 (Optional) Lower the Handle.

Step 6 Tighten the screw on both sides to secure the backsheet and Inverter, ensuring the Inverter Installation is stable.

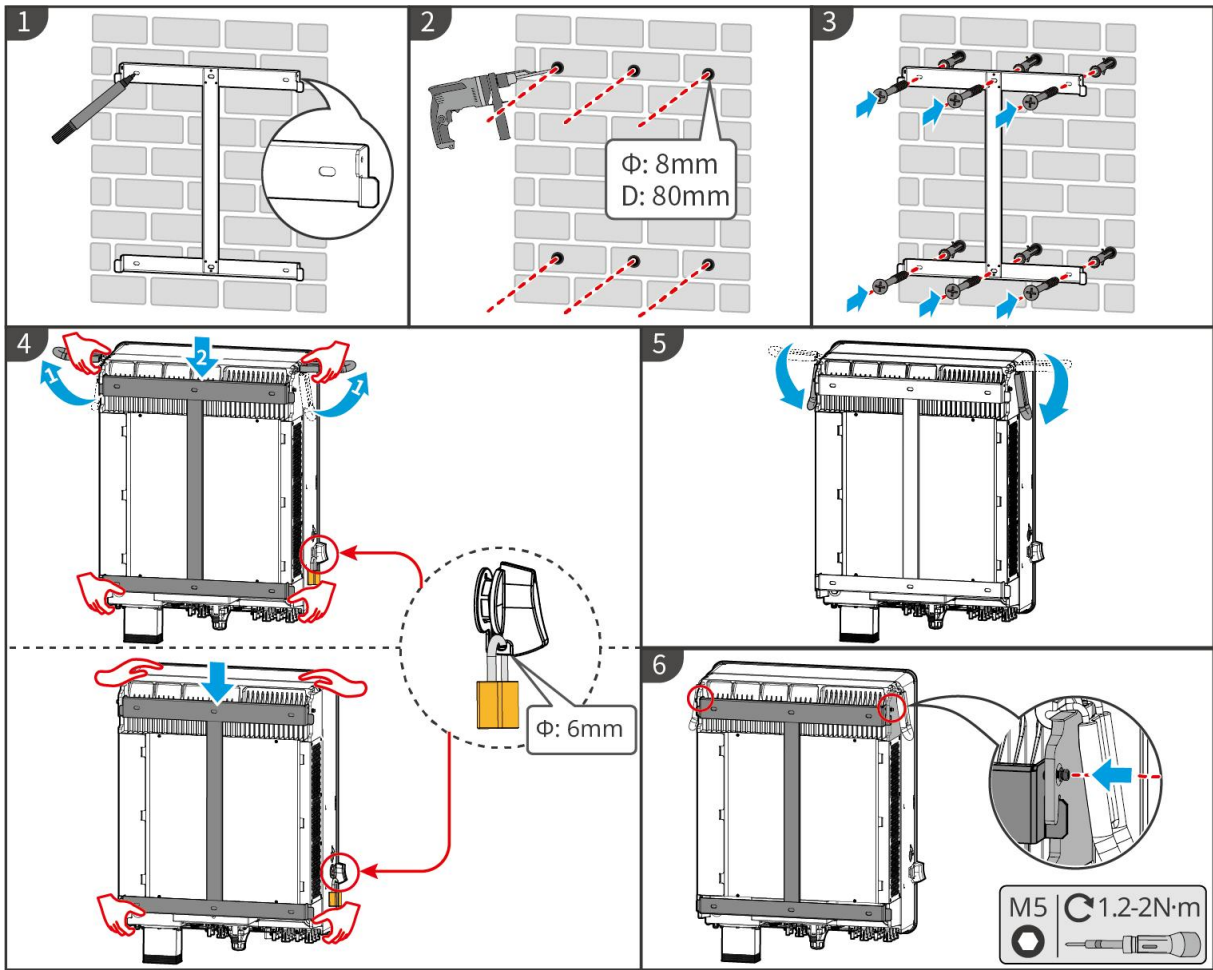

ET3010INT0002

5.5 Installing the Smart Meter



In areas at risk of lightning, if the meter cable exceeds 10m and the cables are not wired with grounded metal conduits, you are recommended to use an external lightning protection device.

GM3000

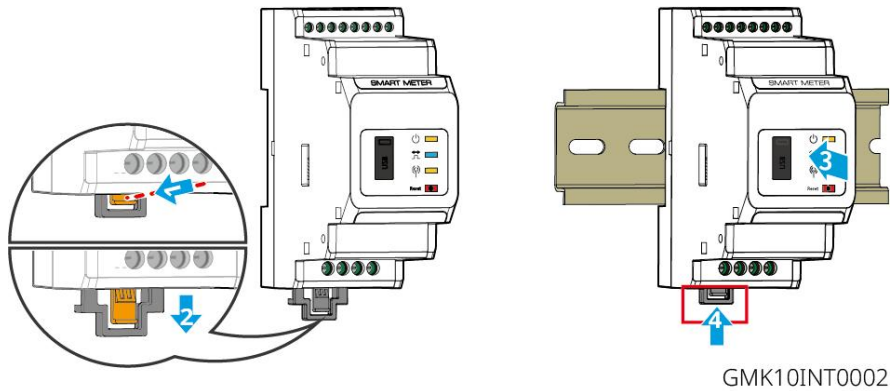

GM330 & GMK330

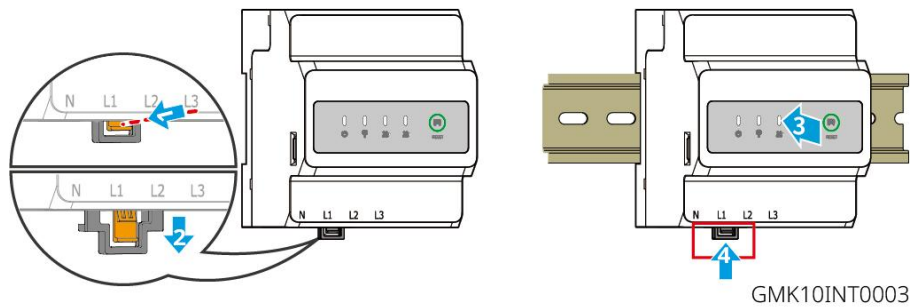

6 System Wiring



DANGER

- Perform electrical connections in compliance with local laws and regulations. Including operations, cables, and component specifications.
- Disconnect the DC switches and the AC output switches to power off the equipment before any electrical connections. Do not work with power on. Otherwise, an electric shock may occur.
- Tie the same type cables together, and place them separately from cables of different types. Do not place the cables entangled or crossed.
- If the cable bears too much tension, the connection may be poor. Reserve a certain length of the cable before connecting it to the Inverter cable port.
- Ensure the cable conductor is in full contact with the terminals during crimping. Do not crimp the cable jacket with the terminal. Otherwise the equipment may not be able to operate, or its terminal block getting damaged due to heating and other phenomenon because of unreliable connection after operation.

NOTICE

- Wear personal protective equipment like safety shoes, safety gloves, and insulating gloves during electrical connections.
- All electrical connections should be performed by qualified professionals.
- Cable colors in this document are for reference only. The cable specifications shall meet local laws and regulations.
- For parallel systems, Follow the safety precautions in the user manuals of related products in the system.

6.1 System Wiring Diagram

NOTICE

- N and PE wiring ON-GRID and BACK-UP of the inverter are different based on the regulation requirements of different regions. Refer to the specific requirements of local regulations.
- There are built-in relays inside of the inverter's ON-GRID and BACK-UP AC ports. When the inverter is in the off-grid mode, the built-in ON-GRID relay is open; while when the inverter is in grid-tied mode, it is closed.
- When the inverter is powered on, the BACK-UP AC port is energized. Power off the inverter first if maintenance is required on the BACK-UP loads. Otherwise, it may cause electric shock.

N and PE cables are connected together in the Main Panel for wiring.

NOTICE

- To maintain neutral integrity, the neutral cable of ON-GRID side and BACK-UP side must be connected together, otherwise BACK-UP function will not work.
- The following diagram is applicable to areas in Australia and New Zealand.

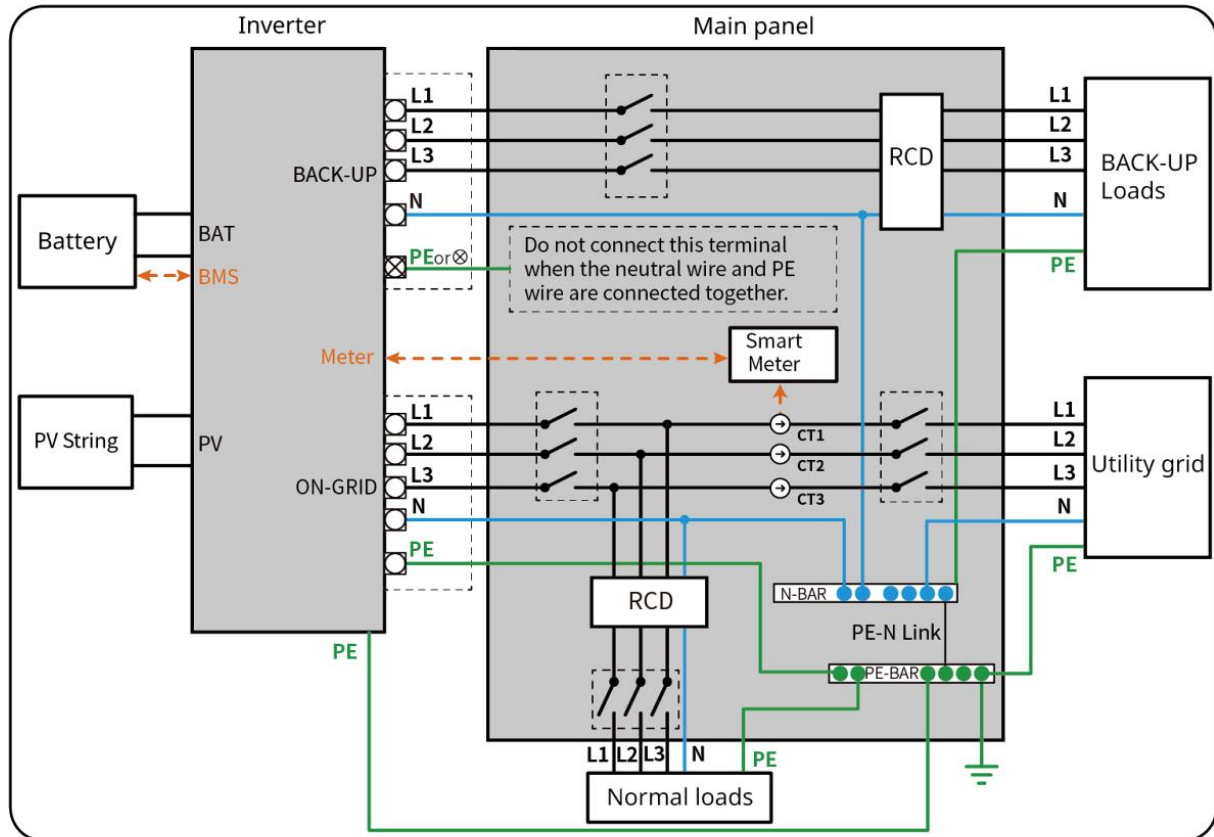

ET3010NET0015

N and PE cables are separately wired in the Main Panel.

NOTICE

- Ensure that the grounding of BACK-UP is correctly and tightened. Otherwise, the BACK-UP function may be abnormal in case of grid failure.
- The following diagram is applicable to areas except Australia or New Zealand.
- In Germany, the internal relay will automatically connect the N wire and PE cable in back-up mode within 100ms and automatically disconnect in on-grid mode.
- In areas other than Germany, the internal relay is disconnected by default in either mode.

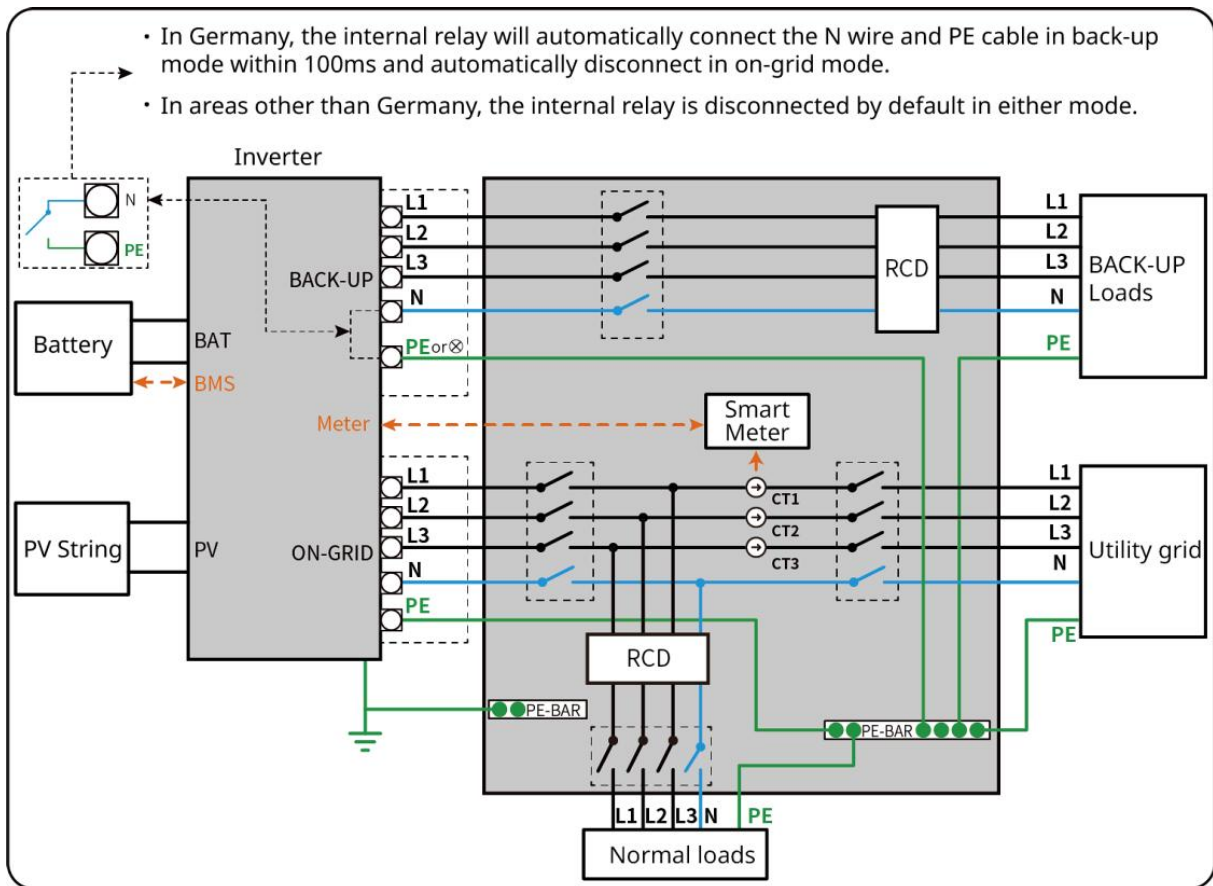

ET3010NET0016

6.2 Detailed System Wiring Diagram

6.2.1 Detailed System Wiring Diagram For Single Inverter

Use GM3000 in the system

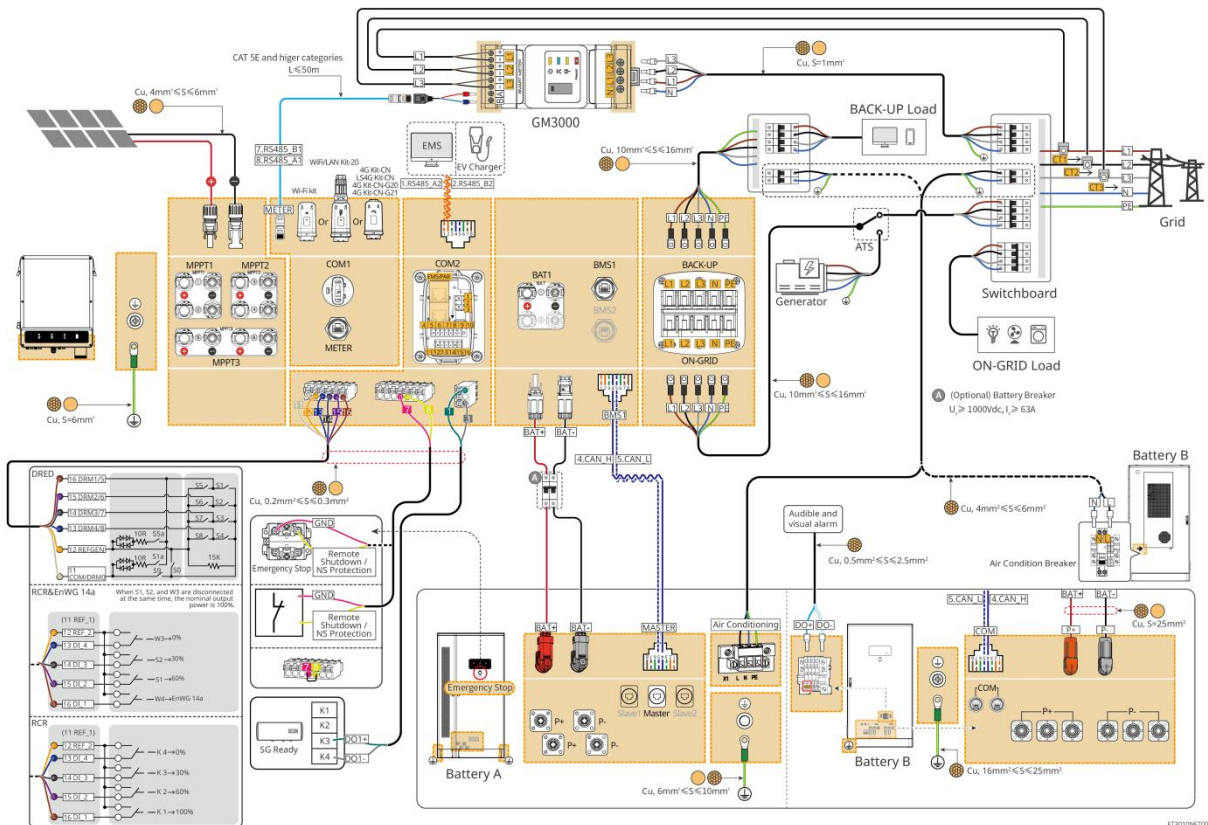

Use GM330 in the system

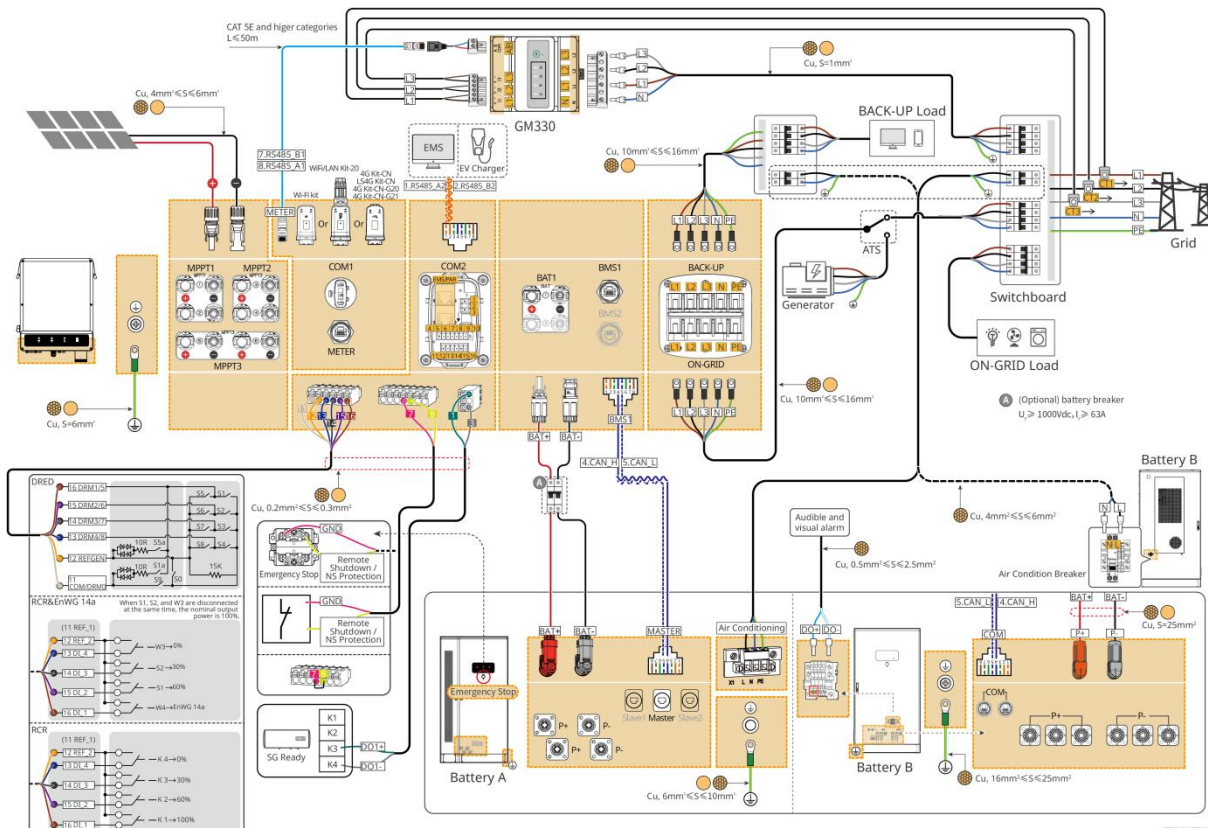

Use GMK330 in the system

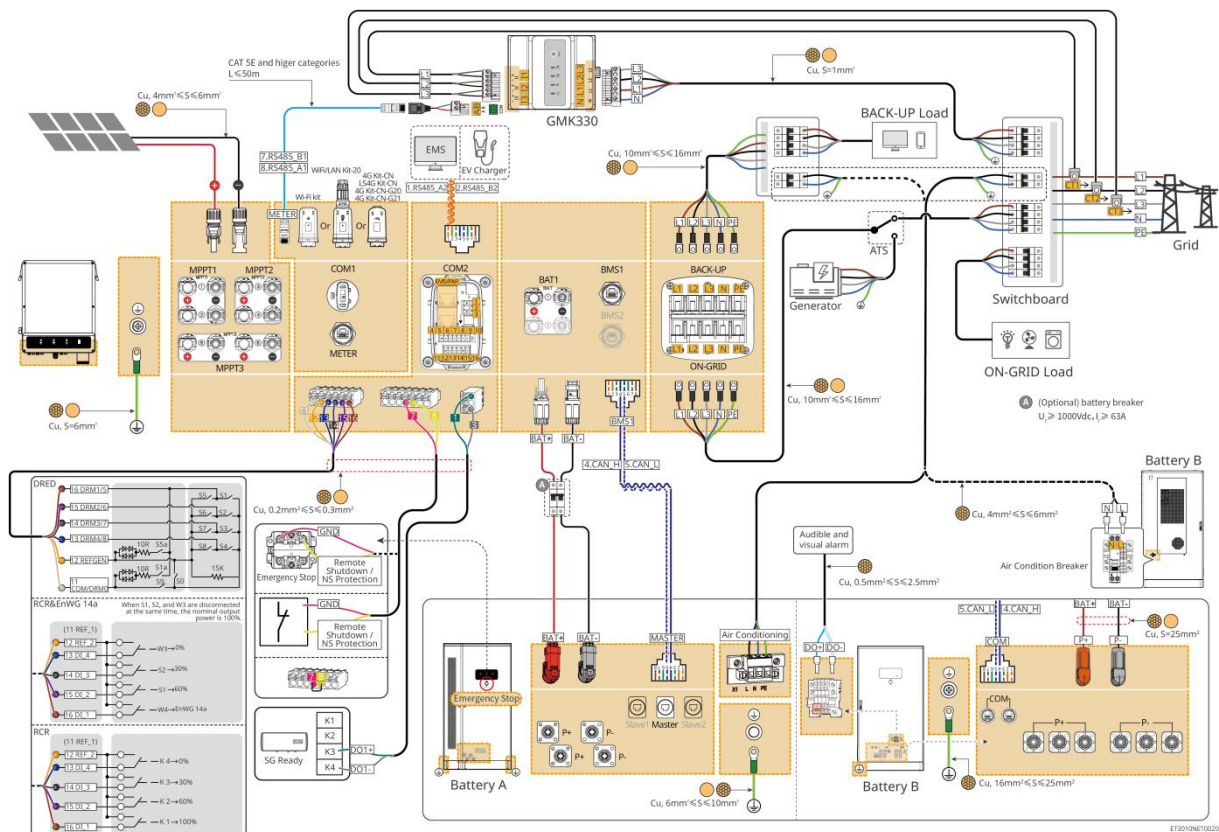

6.2.2 Detailed System Wiring Diagram For Parallel System

- In parallel scenarios, the inverter connecting to Ezlink and smart meter is considered as the master inverter, while all the others are slave inverters. Do not connect any smart dongle to the slave inverters.
- Devices like DRED device, RCR device, remote shutdown device, NS protection device, SG Ready heat pump should be connected to the master inverter.
- The following diagram mainly introduces parallel connections. For other port connections, refer to the single system.

Use GM3000 in the system

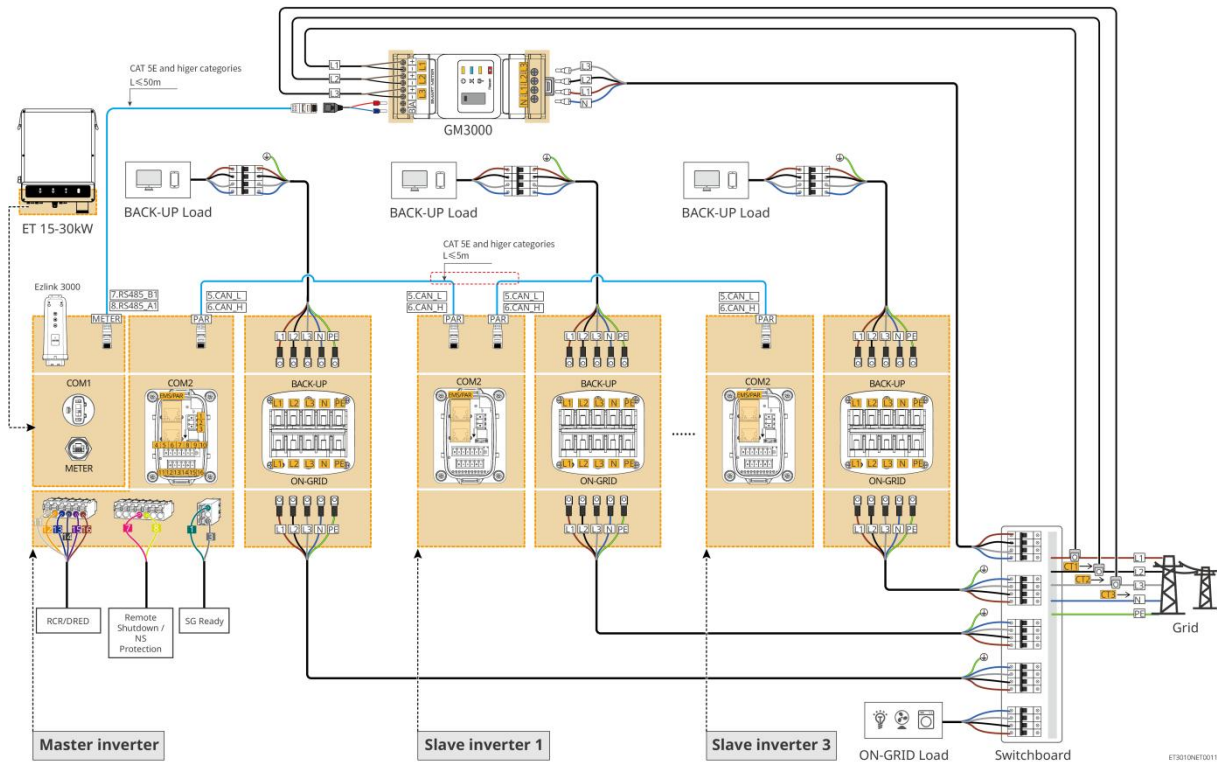

Use GM330 in the system

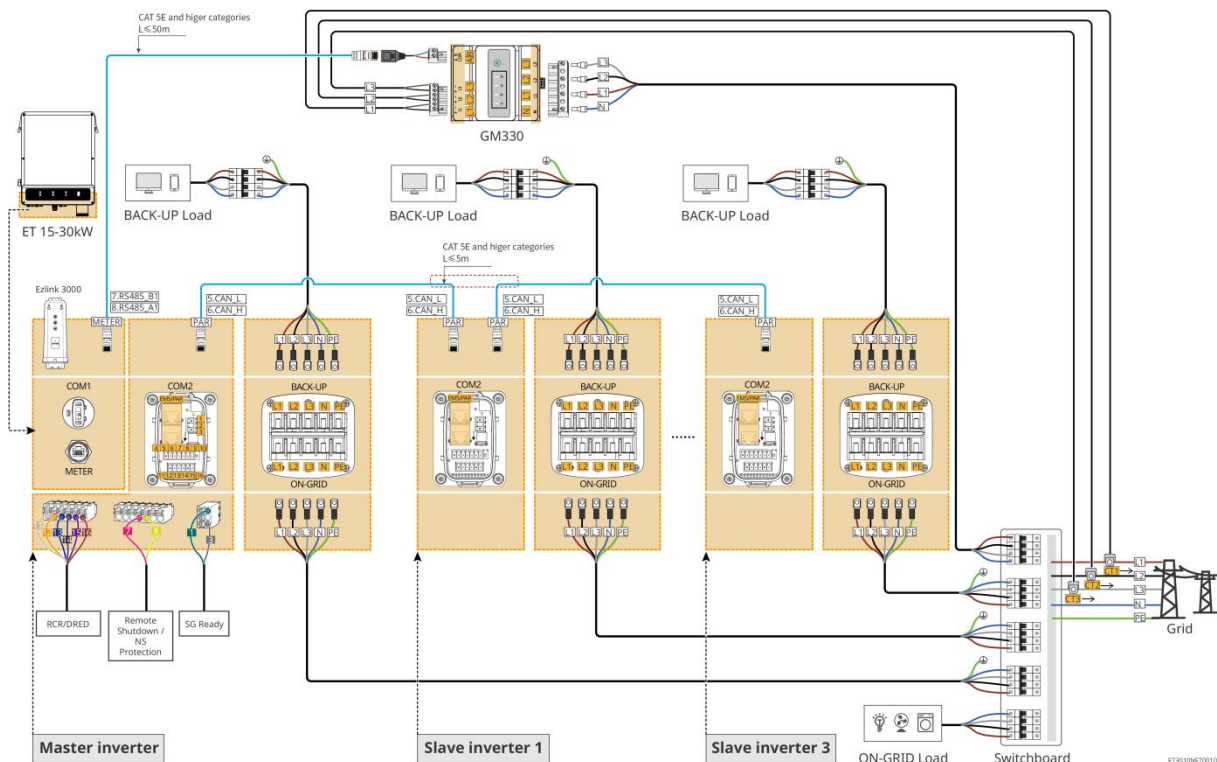

Use GMK330 in the system

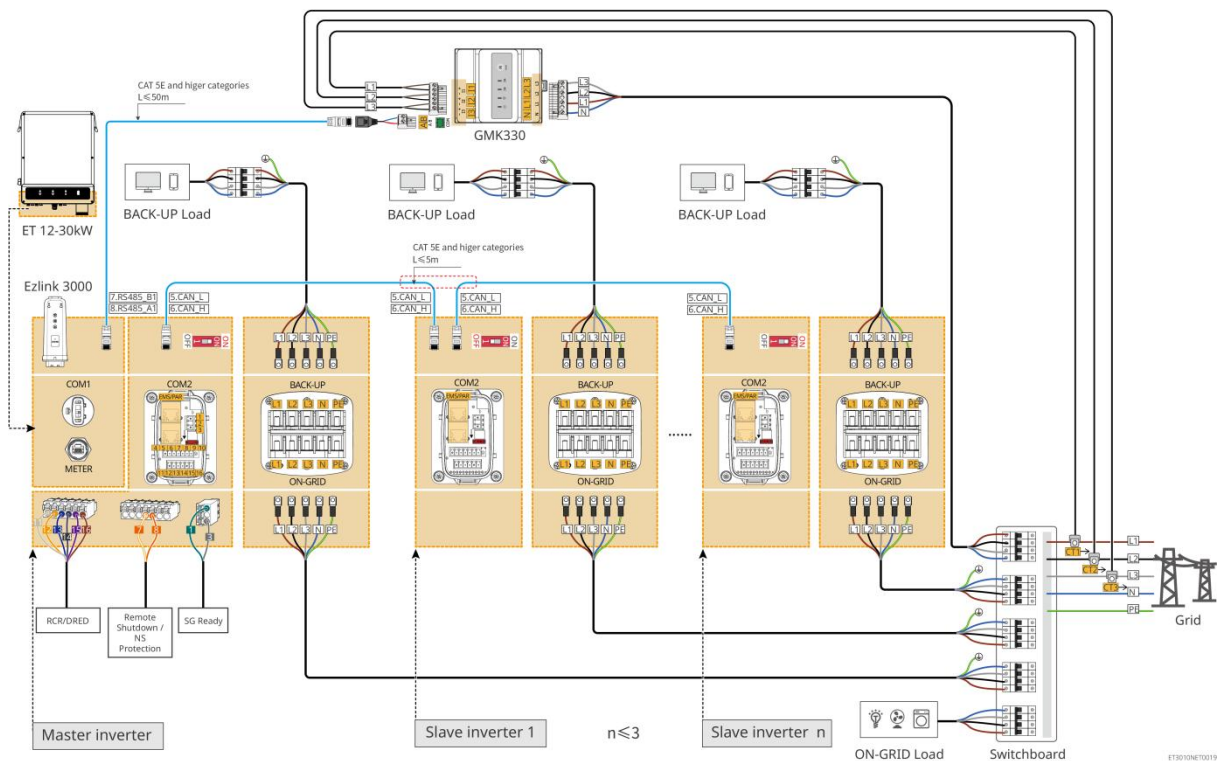

6.3 Preparations Before Wiring



WARNING

- Do not connect loads between the inverter and the AC switch directly connected to the inverter.
- Install one AC output circuit breaker for each inverter. Multiple inverters cannot share one AC circuit breaker.
- An AC circuit breaker shall be installed on the AC side to make sure that the inverter can safely disconnect the grid when an exception happens. Select the appropriate AC circuit breaker in compliance with local laws and regulations.
- When the inverter is powered on, the BACK-UP AC port is energized. Power off the inverter first if maintenance is required on the BACK-UP loads. Otherwise, it may cause electric shock.

6.3.1 Preparing Breakers

No.	Circuit breaker	Recommended specifications	Source	Remark
1	ON-GRID circuit breaker	<p>When the BACK-UP port is not loaded, the rated voltage is $\geq 400V$, and the rated current requirements are as follows:</p> <ul style="list-style-type: none"> ● GW15K-ET: Nominal current $\geq 32A$ ● GW20K-ET: Nominal current $\geq 40A$ ● GW25K-ET: Nominal current $\geq 50A$ ● GW29.9K-ET, GW30K-ET: Nominal current $\geq 63A$ <p>When the BACK-UP port is loaded:</p> <ul style="list-style-type: none"> ● GW15K-ET: Nominal current $\geq 50A$; Nominal voltage $\geq 400V$ ● GW20K-ET、GW25K-ET、GW29.9K-ET、GW30K-ET: Nominal current $\geq 63A$; Nominal voltage $\geq 400V$ 	Prepared by customers.	If the inverter's BACK-UP port is not used, a suitable circuit breaker can be selected based on the maximum AC output current.
2	BACK-UP circuit breaker	<p>Nominal voltage $\geq 400V$, nominal current:</p> <ul style="list-style-type: none"> ● GW15K-ET: Nominal current $\geq 32A$ ● GW20K-ET: Nominal current $\geq 40A$ ● GW25K-ET: Nominal current $\geq 50A$ <p>GW29.9K-ET, GW30K-ET: Nominal current $\geq 63A$</p>	Prepared by customers.	-
3	Battery breaker	<p>Optional in compliance with local laws and regulations:</p> <ul style="list-style-type: none"> ● 2P DC breaker ● Nominal current $\geq 63A$ ● Nominal Voltage $\geq 1000V$ 	Prepared by customers.	-
4	RCD	Optional in compliance with local laws and regulations:	Prepared by	-

No.	Circuit breaker	Recommended specifications	Source	Remark
		<ul style="list-style-type: none"> ● Type A ● ON-GRID RCD: 300mA ● BACK-UP RCD: 30mA 	customers.	
5	Smart meter breaker	<ul style="list-style-type: none"> ● Nominal voltage: 300V ● Nominal current: 0.5A 	Prepared by customers.	-

6.3.2 Preparing Cables

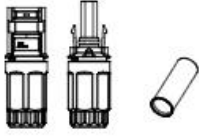
No.	Circuit breaker	Recommended specifications	Source
1	Inverter PE cable	-	Pre-installed in the Battery AC compartment
2	Battery PE cable	<ul style="list-style-type: none"> ● single core Outdoor copper cable ● Conductor cross-sectional area: 6mm²-10mm² 	Self-contained
3	PV DC line	<ul style="list-style-type: none"> ● Industry-standard outdoor photovoltaic cables ● Conductor cross-sectional area: 4mm²-6mm² ● Cable outer diameter: 5.9mm-8.8mm 	Self-supply
	Battery DC line GW60KWH-D-10 GW60KWH-D-10 (Extension)	-	Supplied with the box
4	Battery DC line GW61.4-BAT-AC-G10 GW92.1-BAT-AC-G10 GW102.4-BAT-AC-G10 GW112.6-BAT-AC-G10	<p>Type I terminal</p>  <ul style="list-style-type: none"> ● single core Outdoor copper cable ● Conductor cross-sectional area: 10mm² ● Cable outer diameter: 6.0mm-9.5mm 	Self-supply

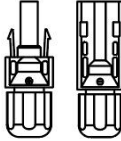
No.	Circuit breaker	Recommended specifications	Source
		Type II terminal  <ul style="list-style-type: none"> ● single core Outdoor copper cable ● Conductor cross-sectional area: 10mm² ● Cable outer diameter: 6.5mm-8.5mm 	
5	Cluster DC bus line GW60KWH-D-10 GW60KWH-D-10 (Extension)	<ul style="list-style-type: none"> ● single core Outdoor copper cable ● Conductor cross-sectional area: 32mm²-35mm² ● Cable outer diameter: 10mm-12mm 	Self-contained
6	AC line	<ul style="list-style-type: none"> ● multi-core outdoor copper cable ● Conductor cross-sectional area: 10mm²-16mm² ● Cable outer diameter: 21mm-26mm 	Self-contained
7	Smart Meter power cable	<ul style="list-style-type: none"> ● Outdoor copper cable ● Conductor cross-sectional area: 1mm² 	Self-contained
8	Battery Management System (BMS)	-	Supplied with the box
9	Electric meter RS485	-	RJ45-2PIN terminal conversion cable and standard network cable, included with the case.
10	Battery cluster combiner Communication cable	CAT 5E and above specifications standard network cable and RJ45 RJ45 connector	Self-supply
11	load control DOC Communication cable	<ul style="list-style-type: none"> ● Shielded wire compliant with local standards 	Self-supply
12	remote shutdown Communication cable	<ul style="list-style-type: none"> ● Conductor cross-sectional area: 0.2mm²-0.3mm² ● Cable outer diameter: 	Self-supply
13	RCR/DRED signal line	<ul style="list-style-type: none"> ● Cable outer diameter: 5mm-8mm 	Self-supply

No.	Circuit breaker	Recommended specifications	Source
14	Inverter parallel operation Communication cable	CAT 5E and above specifications standard network cable and RJ45 RJ45 connector	Self-supply
15	Energy Management System (EMS)	CAT 5E and above specifications standard network cable and RJ45 RJ45 connector	Self-supply
16	12V external power supply	Outdoor copper cable Conductor cross-sectional area: 0.2mm ² -0.3mm ² Cable outer diameter: 5mm-8mm	Self-supply
17	Air conditioner power cable GW60KWH-D-10 GW60KWH-D-10 (Extension)	-	Pre-installed
	Air conditioning power cable GW61.4-BAT-AC-G10 GW92.1-BAT-AC-G10 GW102.4-BAT-AC-G10 GW112.6-BAT-AC-G10		Supplied with the box

6.3.3 Removing the Base Plate

WARNING

- After completing the system Installation, before starting the wiring, please dismantle the baffle.
- After completing the System Wirings, please install the baffle Installation into the enclosure.

Bottom baffle

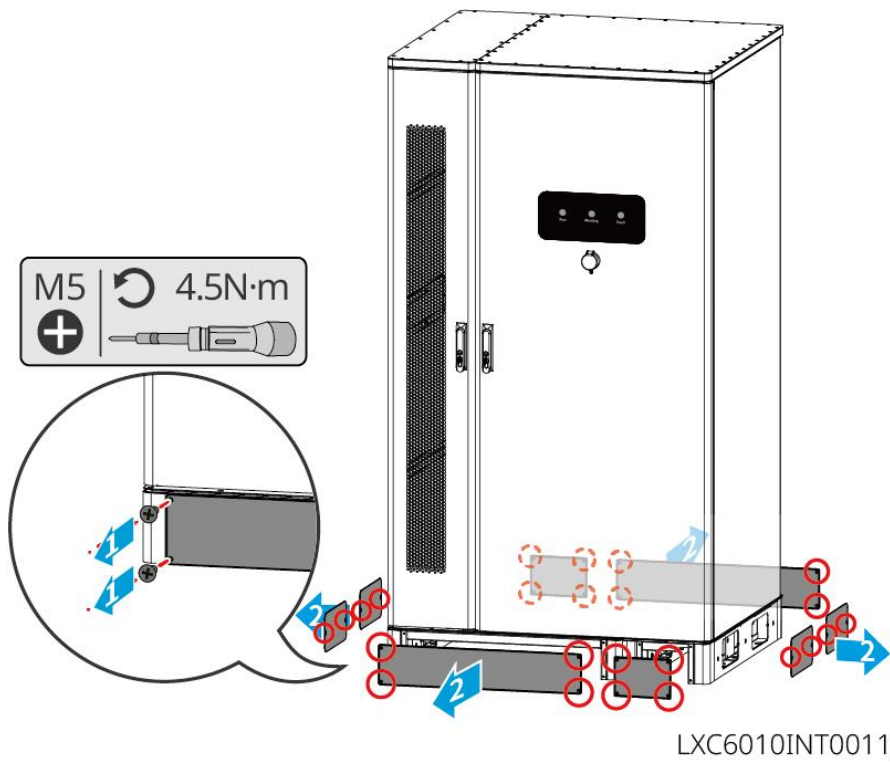

Inverter Terminal Block Baffle

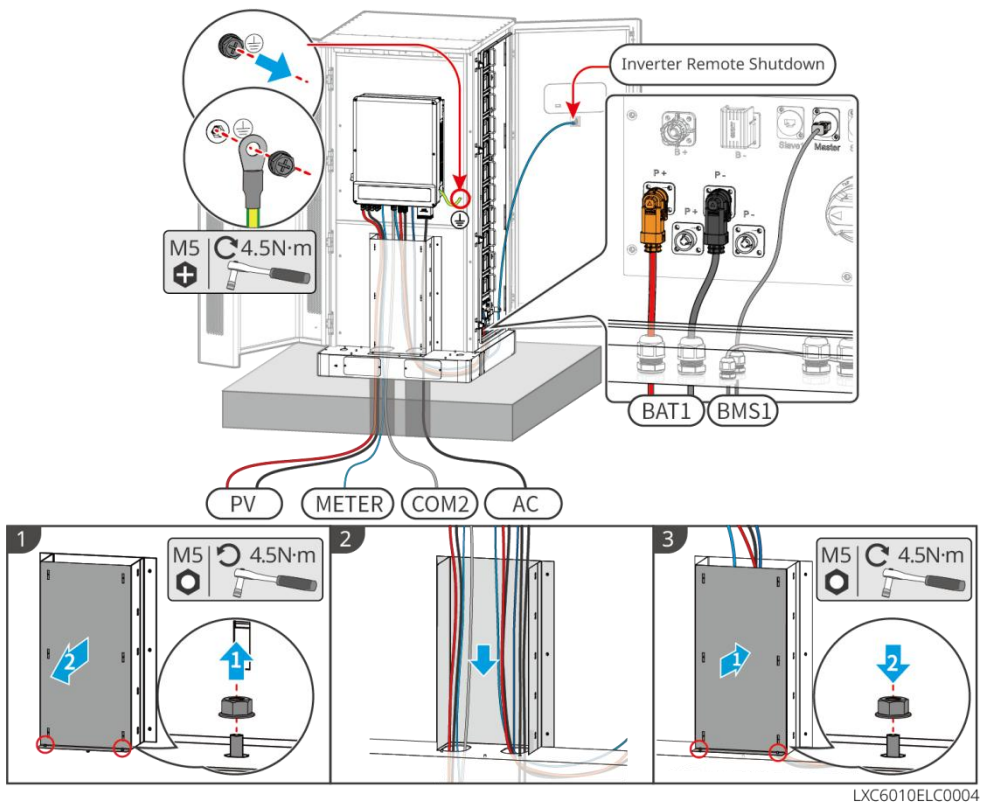

6.4 Connecting the PE cable



WARNING

- Connect the PE cable first before installing the equipment. Disconnect the PE cable before dismantling the equipment.
- Make sure that all the grounding points on the enclosures are equipotentially connected when there are multiple inverters.
- To improve the corrosion resistance of the terminal, you are recommended to apply silica gel or paint on the ground terminal after installing the PE cable.
- The PE cable should be prepared by the customer.

Inverter



WARNING

The grounding point of the inverter enclosure cannot replace the grounding point of the AC output port. Ensure that both two grounding cables are securely connected.

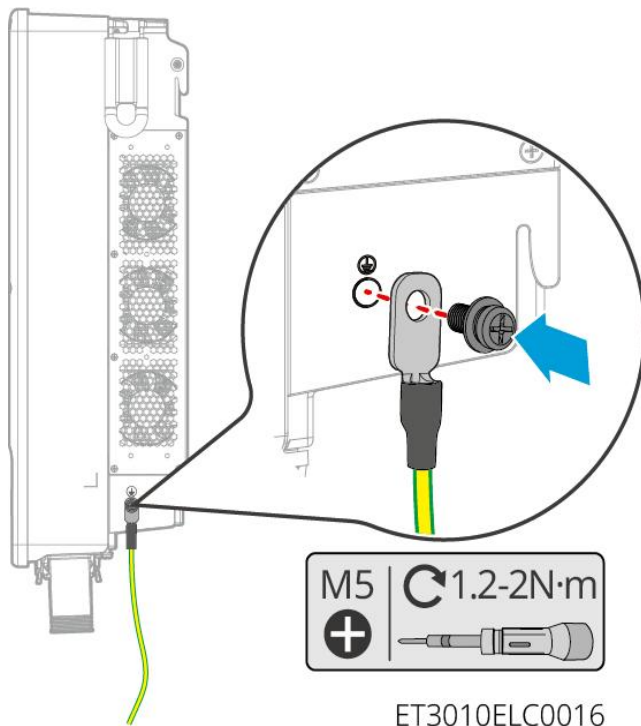

Battery system



WARNING

Choose and connect one grounding point on either side of the battery system based on actual situation.

- **GW60KWH-D-10, GW60KWH-D-10 (Extension)**

Type I

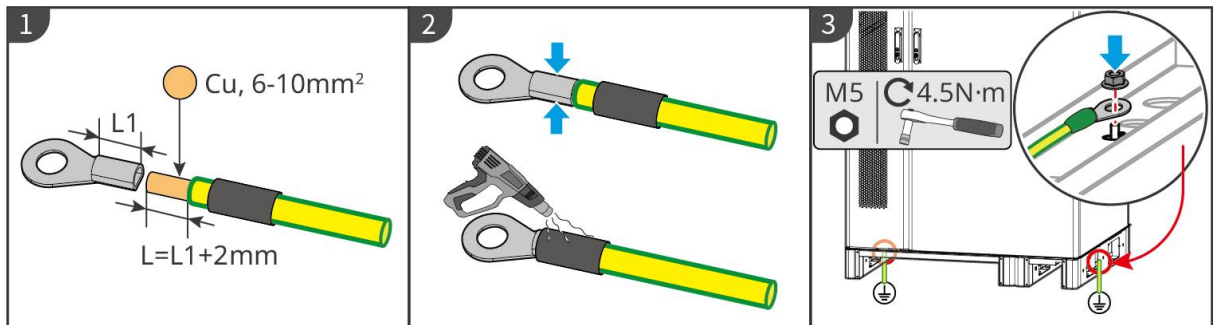

LXC6010ELC0001

Type II

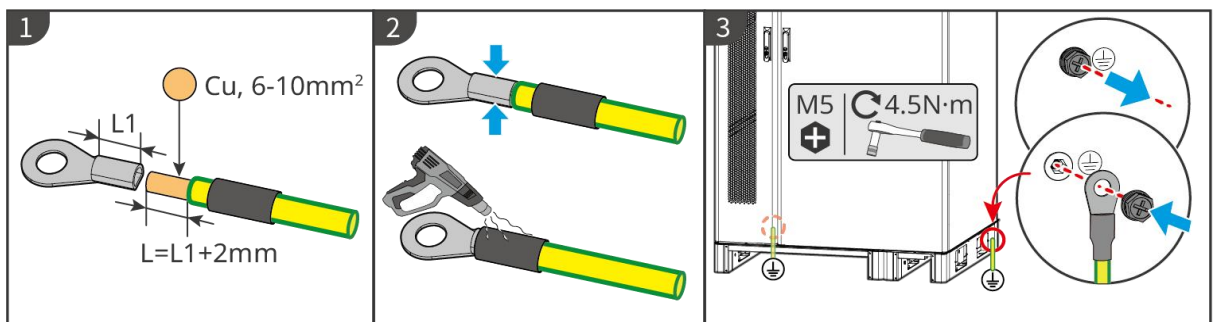

LXC6010ELC0001

- **GW61.4-BAT-AC-G10, GW92.1-BAT-AC-G10, GW102.4-BAT-AC-G10, GW112.6-BAT-AC-G10**

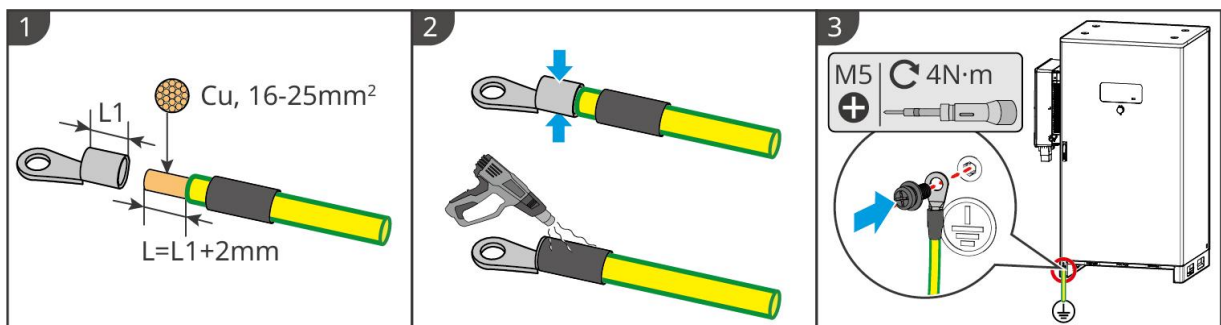

BAT10ELC0007

6.5 Connecting the PV Cable



- Do not connect one PV string to more than one inverter at the same time. Otherwise, it may cause damage to the inverter.
- Confirm the following information before connecting the PV string to the inverter. Otherwise, the inverter may be damaged permanently or even cause fire and cause personal and property losses.

1. Make sure that the max short circuit current and the max input voltage per MPPT are within the permissible range.
2. Make sure that the positive pole of the PV string connects to the PV+ of the inverter. And the negative pole of the PV string connects to the PV- of the inverter.

! WARNING

- The PV strings cannot be grounded. Ensure the minimum insulation resistance of the PV string to the ground meets the minimum insulation resistance requirements before connecting the PV string to the inverter ($R = \text{maximum input voltage} / 30\text{mA}$).
- Ensure the DC cables are connected tightly, securely and correctly.
- Measure the DC cable using the multimeter to avoid reverse polarity connection. Also, the voltage should be within the permissible range.

NOTICE

The two input strings per MPPT should be of the same type, the same number of modules, the same tilt and angle to ensure the best efficiency.

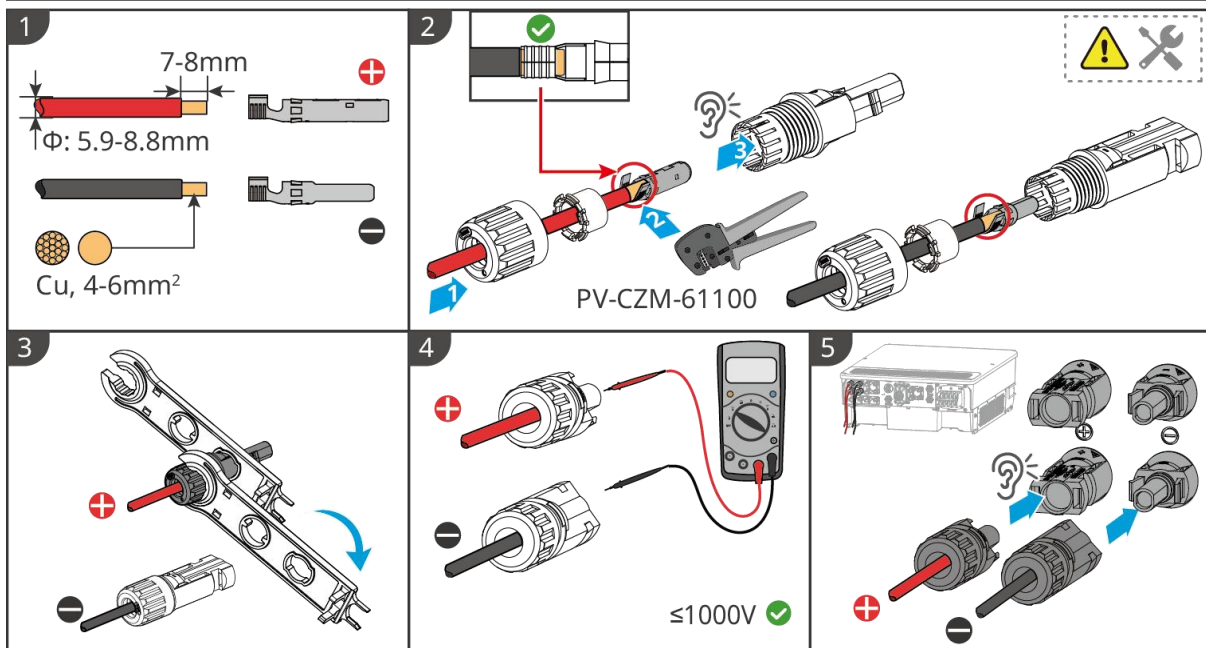

ET3010ELC0002

6.6 Connecting the Battery Cables

! DANGER

- Do not connect the same Battery group to multiple Inverters, as this may cause damage to the Inverter.
- Do not connect any load between Inverter and Battery.
- When Connecting the Battery Cable, use insulated tools to prevent accidental electric

shock or Battery short circuit.

- Please ensure that Battery open-circuit voltage is within the allowable range of Inverter.
- Before Connecting the Battery Cable, ensure that the Battery module and the high-voltage box are POWER OFF, and that both the Battery cluster switch and the DC power supply switch are turned off.
- Between Inverter and Battery, please decide whether to configure DC switch based on local laws and regulations.



WARNING

- Use a multimeter to measure the positive and negative poles of the DC cable, ensuring correct polarity without reverse connection; and confirm the voltage is within the allowable range.
- When wiring, the Battery wire must fully match the "BAT+", "BAT-", and grounding port of the Battery terminal. Incorrect cable connections will result in equipment damage.
- Please ensure the conductor is fully inserted into the terminal terminal hole without any exposure.
- Please ensure that the cable connections are securely fastened, otherwise, loose connections may cause overheating of the terminal during equipment operation, leading to potential damage.
- Do not connect the same Battery group to multiple Inverters, as this may cause damage to the Inverter.

Battery system wiring diagram

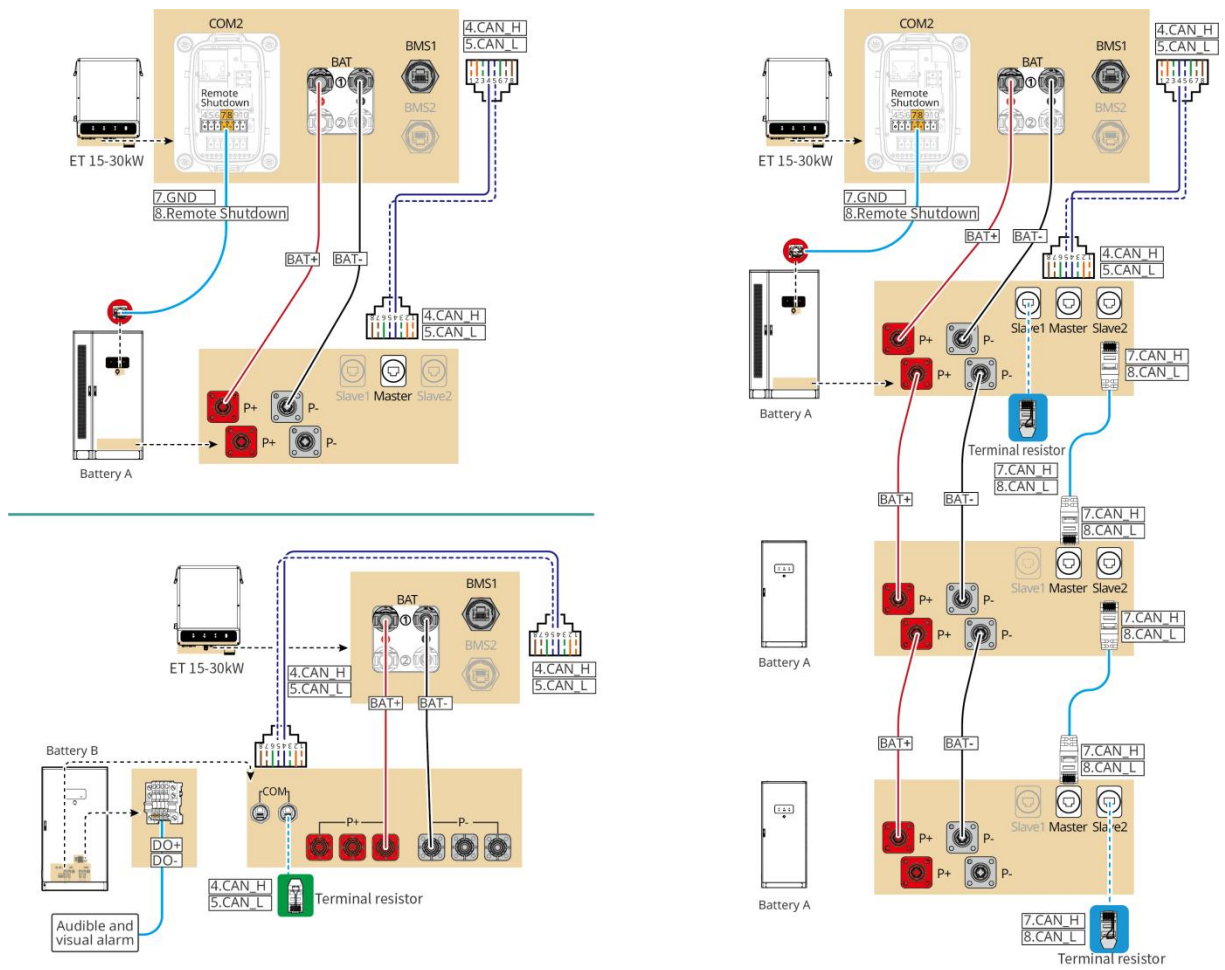

CAT 5E and higher categories

ET3010NET0012

6.6.1 Compatible with GW60KWH-D-10, GW60KWH-D-10

(Extension)

6.6.1.1 Introduction to wiring holes

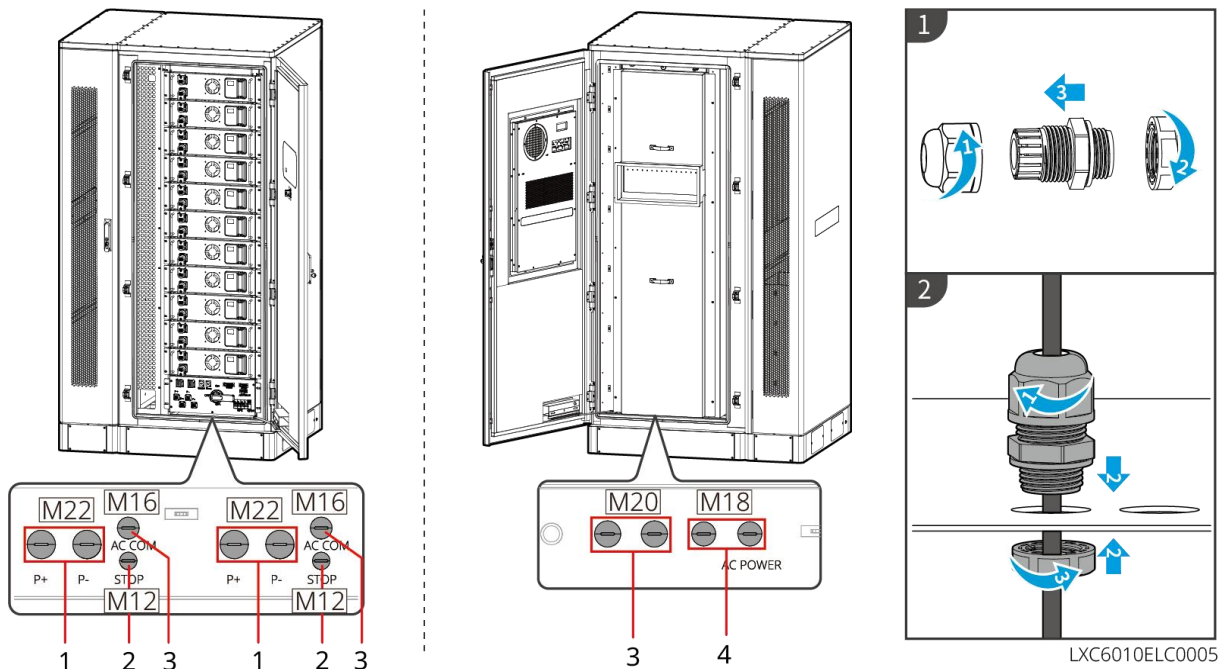

No.	Description	No.	Description
1	Hole for battery power cable	2	Hole for emergency button cable
3	Hole for communication cable	4	Hole for air conditioner cable
5	Reserved	-	-

6.6.1.2 Connecting Power Cable Between the Inverter and Battery

⚠ WARNING

- Measure the DC cable using the multimeter to avoid reverse polarity connection. Also, the voltage should be within the permissible range.
- When wiring, ensure that the P+ of the power control unit connects to the BAT+ of the inverter, and the P- connects to the BAT-. If the cable connection is incorrect, it will cause equipment damage. Incorrect wiring will damage the equipment.
- Ensure that the whole cable cores are inserted into the terminal holes. No part of the cable core can be exposed.
- Ensure that the cables are connected securely. Otherwise it will cause damage to the

inverter due to overheat during its operation.

- Do not connect one battery pack to more than one inverter at the same time. Otherwise, it may cause damage to the inverter.

NOTICE

- The battery system comes with power cables for connection to the inverter.
 - If the inverter accessory kit includes Type I terminals, cut off the terminals on the power cable in the battery accessory kit that connect to the inverter, and use the battery connector shipped with the inverter to remake the power cable.
 - If type II terminals are shipped with the inverter accessories, the power cables shipped with the battery accessories can be used directly.
 - If there are no terminals connected to the inverter on the power cable in the battery accessories, use the connector in the inverter accessories to make the power cable.
- Prepare the battery power cable for parallel connections.
- Connect the battery system to the BAT1 port of the inverter.

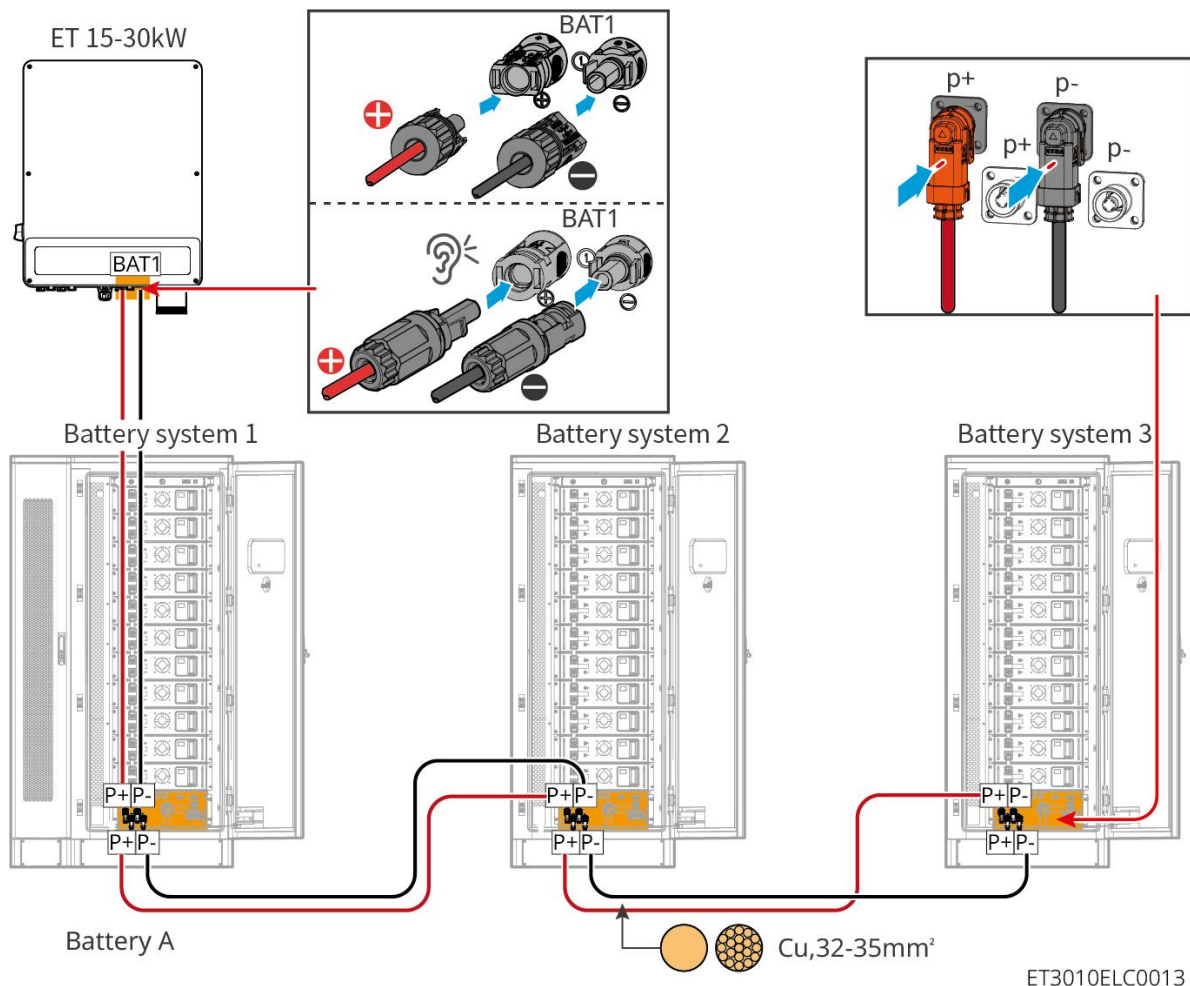

Make the inverter power cable

Type I

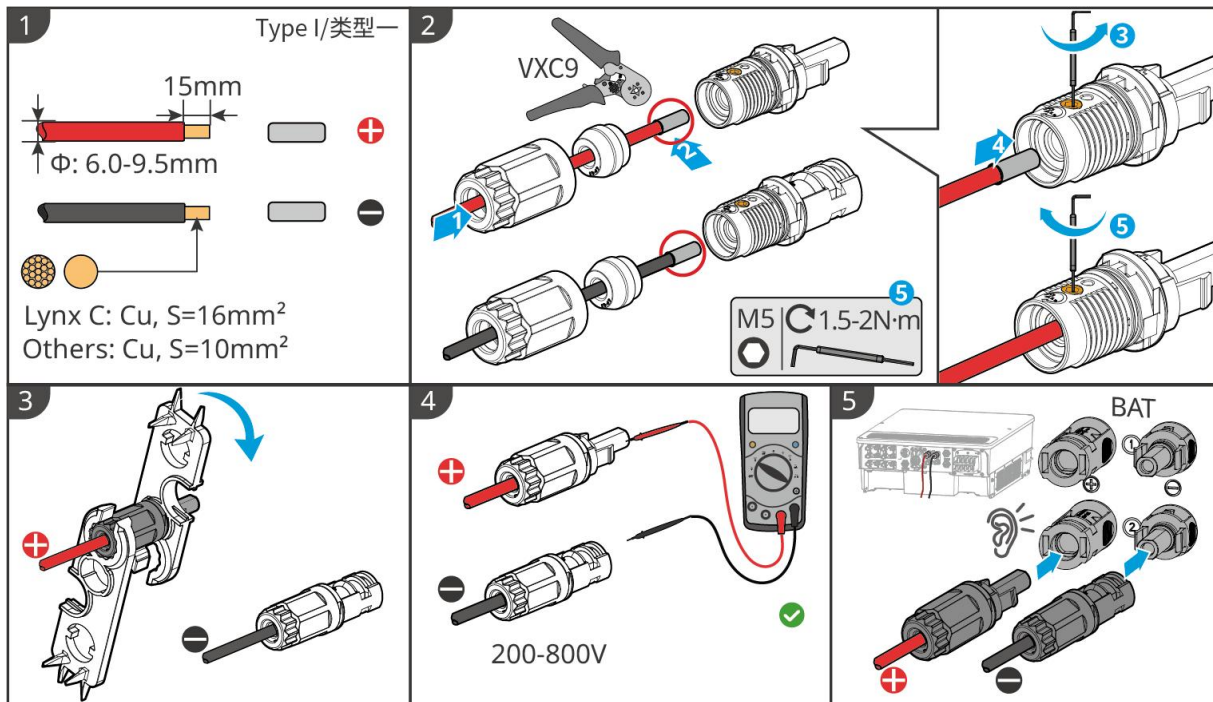

ET3010ELC0031

Type II

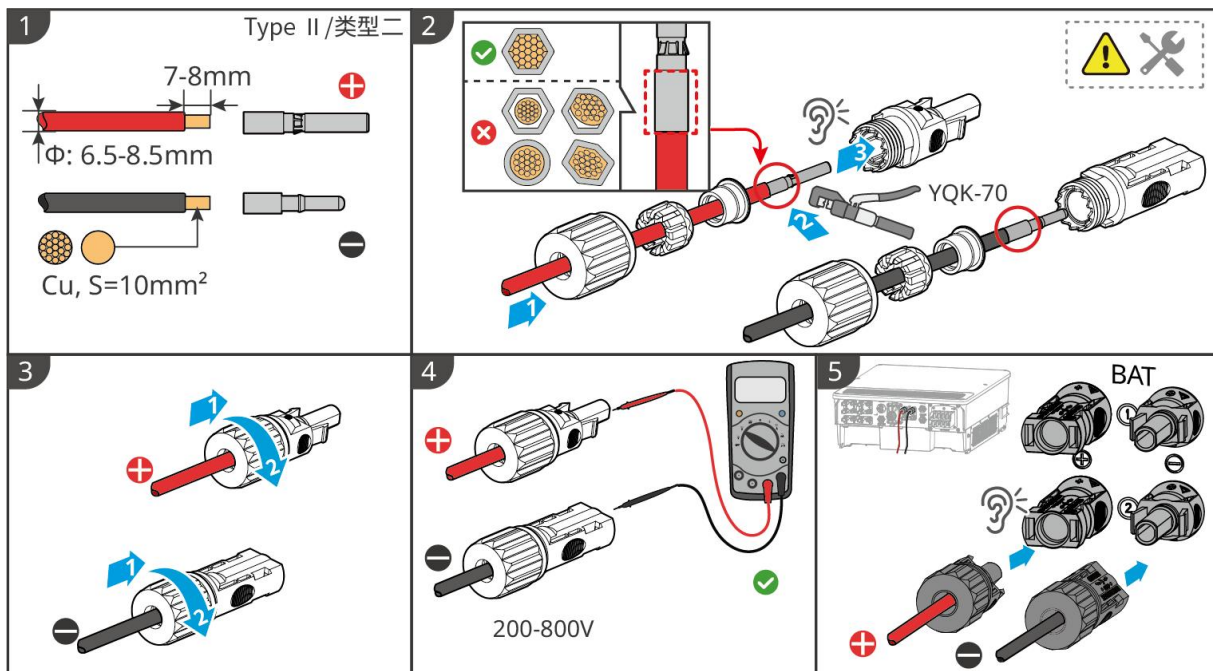

ET3010ELC0032

Make the battery power cable for parallel connections

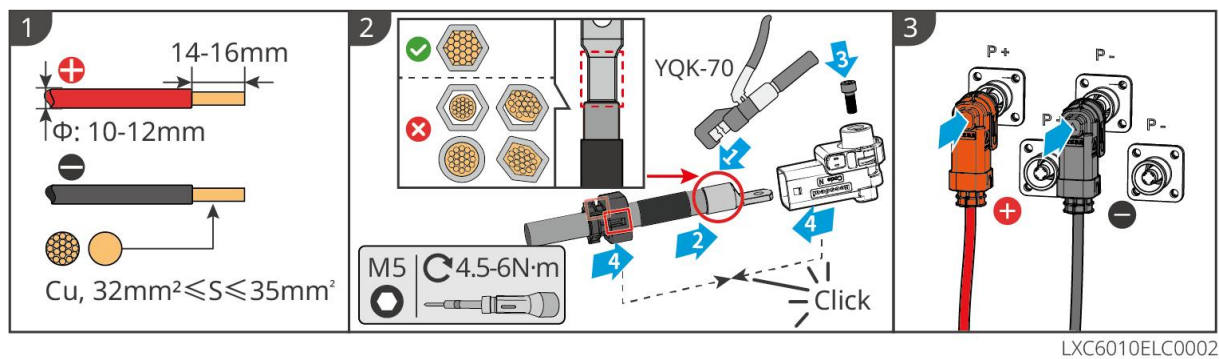

6.6.1.3 Connecting the Battery Communication Cable

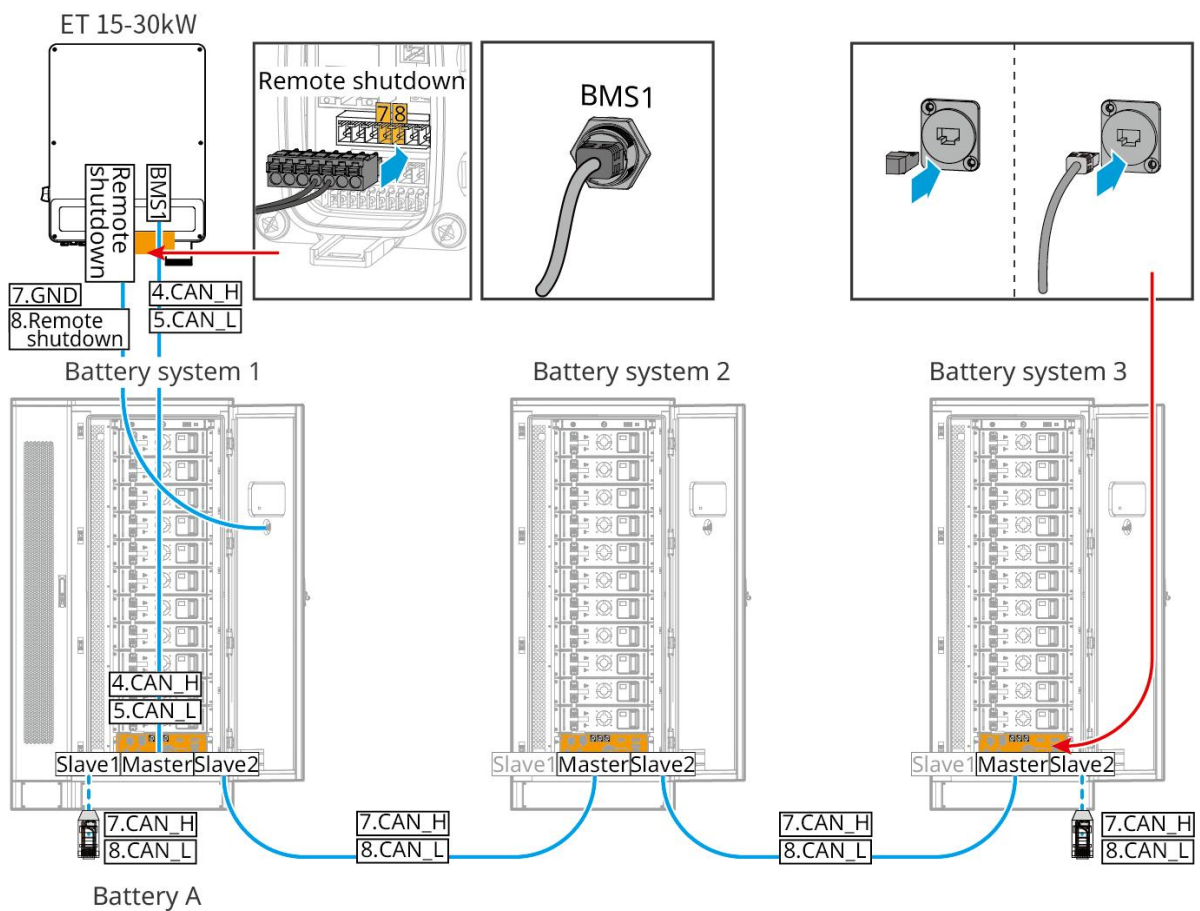

WARNING

Do not forget the terminal resistor of the battery system. Otherwise, the communication between the battery systems may fail.

NOTICE

- Use the BMS battery communication cable provided with the battery system. If the communication cable supplied is not sufficient, prepare shielded network cables and

shielded RJ45 connectors.

- Connect the battery system to the BMS1 communication port of the inverter, otherwise, the communication may fail.
- The emergency stop switch communication cable is pre-installed in the cabinet. If the provided cable is insufficient, prepare additional communication cables.
- Prepare EIA/TIA-568B shielded network cables and shielded RJ45 connectors for communication between parallel connected battery systems.
- PIN4 and PIN5 are for inverter communication only. It is not necessary to crimp PIN4 and PIN5 for communication between parallel connected battery systems.
- For parallel connected battery systems, connect the remote shutdown port of the inverter to the master battery system.

BMS communication connections between the inverter and the battery:

Equipment	Ports	Definition	Description
Inverter	BMS1	4: CAN_H 5: CAN_L	CAN communication between inverter and battery
	Remote Shutdown	7: GND 8: Remote shutdown	Connects to battery system to control battery emergency shutdown
Battery	Slave1	7: CAN_H 8: CAN_L	CAN communication between battery systems
	Master	1: RS485_A1 2: RS485_B1	Reserved for inverter communication
		4: CAN_H 5: CAN_L	Communicates with the inverter
		7: CAN_H 8: CAN_L	CAN communication between battery systems
	Slave2	7: CAN_H 8: CAN_L	CAN communication between battery systems
	Emergency stop switch	1: NC 2: COM	Connects to the inverter to control battery emergency stop

6.6.1.4 Connecting the Battery Power Cables

NOTICE

If the aluminum bars of the battery system have been installed before leaving the factory, please use tools to recheck the torque.

Part of aluminum bars between batteries have been installed:

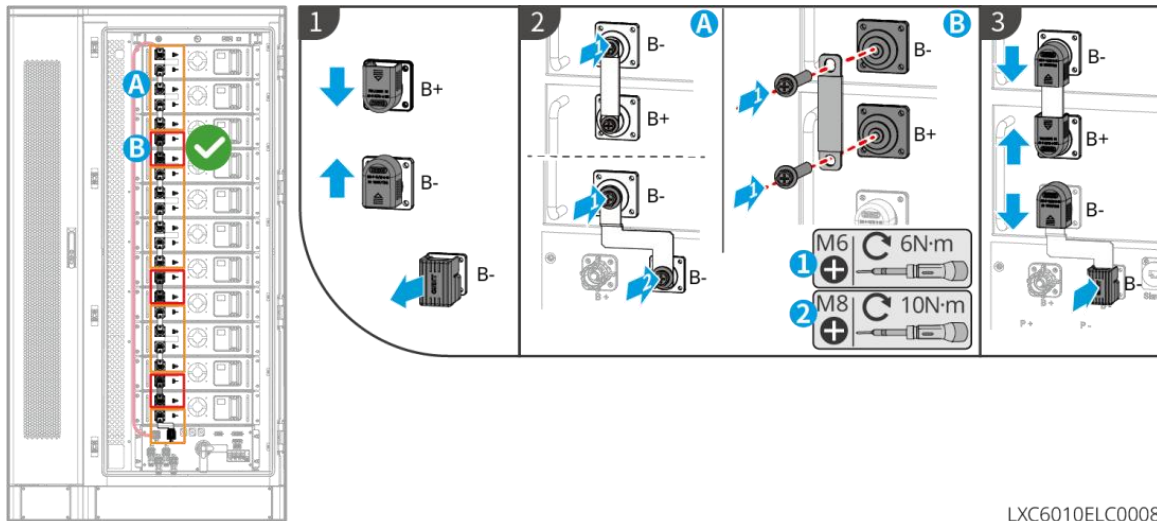

Aluminum bars between batteries are not installed:

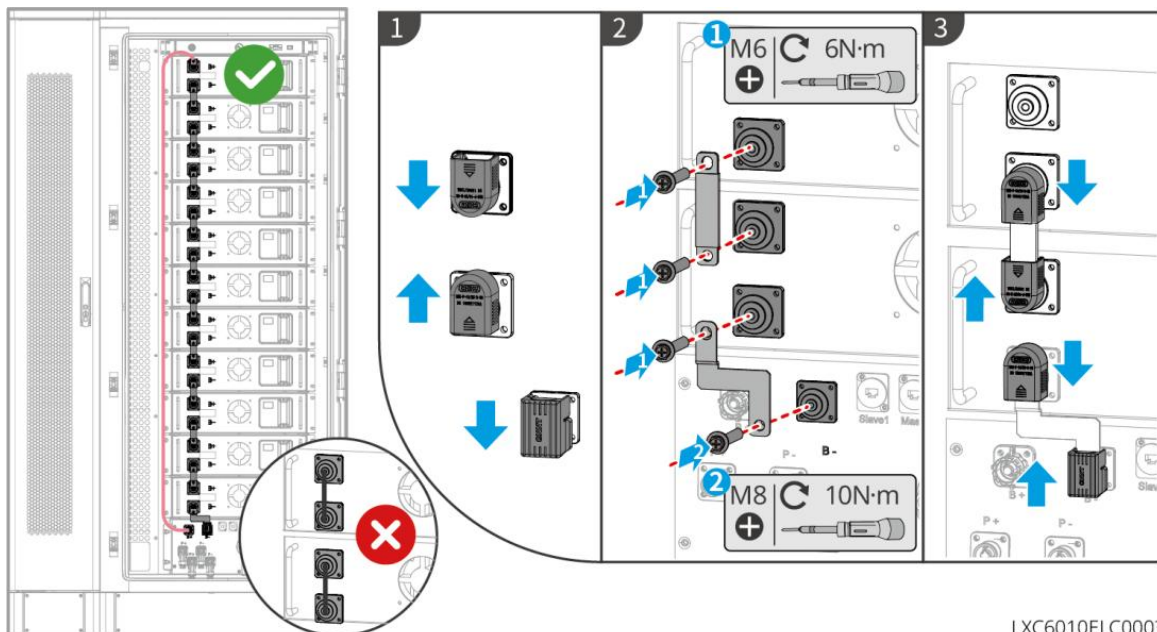

6.6.1.5 Connecting the Air Conditioner Power Cable

NOTICE

- The air conditioner power cable is pre-installed in the battery system cabinet. If the supplied power cable is insufficient, prepare extension cables.
- It is recommended to connect the air conditioner power cable to the power distribution box.
- Connect the air conditioner power cable to the BACK UP port of the inverter for emergency use.
- To ensure safe disconnection in case of emergencies, install an AC switch between the air conditioner and the distribution box. The AC switch should be at least 16A.
- To ensure the heat dissipation performance, do not arbitrarily change the default temperature parameter settings of the air conditioner.

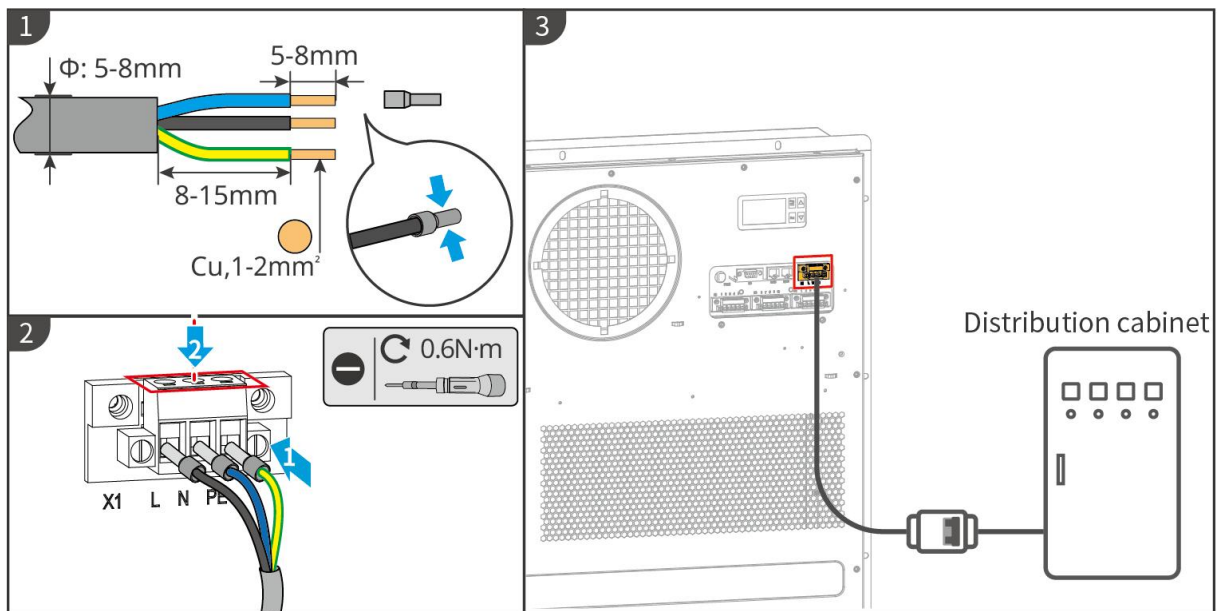

LXC6010ELC0006

6.6.1.6 Connecting the Air Conditioner Hose

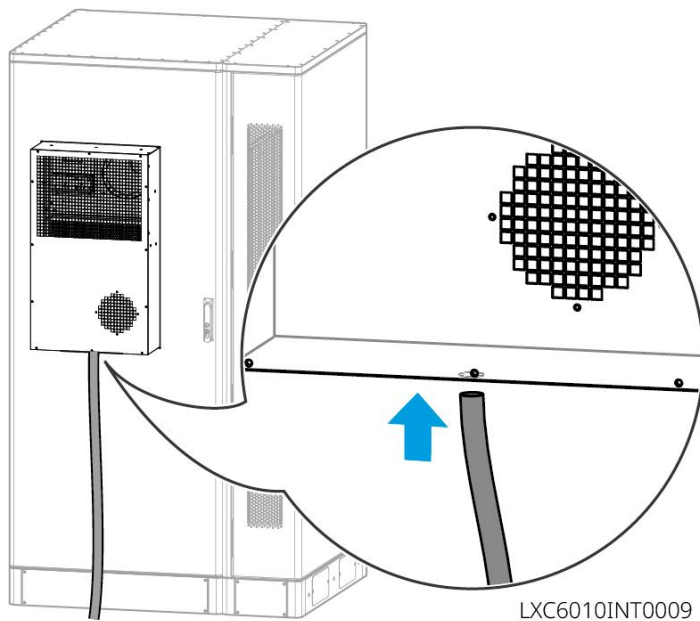

6.6.1.7 Turn On the Fire Switch

NOTICE

The "open" (turn on) and "close" (turn off) functions of firefighting equipment can only be activated during professional maintenance or replacement of the thermal activation component.

Fire equipment switch operation scenario:

- Do not operate if there is a "Do Not Operate" tag.

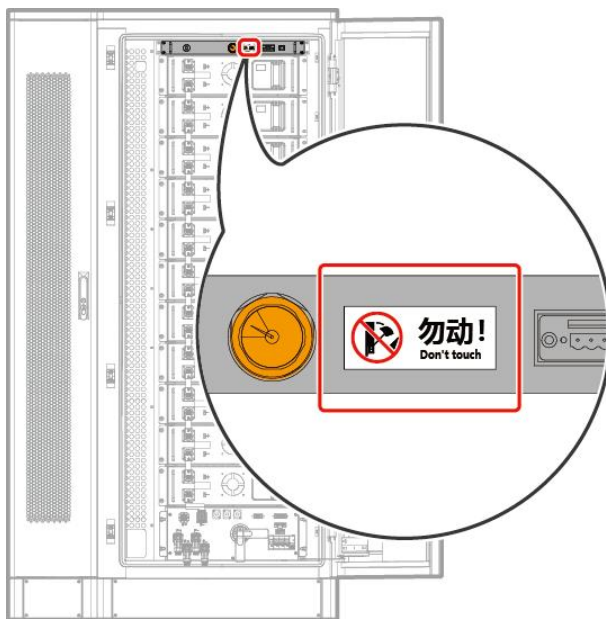

- If there is no label, please follow the steps below to open the fire switch. Using a 14mm wrench, turn the screw behind the pressure gauge counterclockwise approximately 1.5 turns until it is fully tightened, and the fire protection system will be successfully activated.

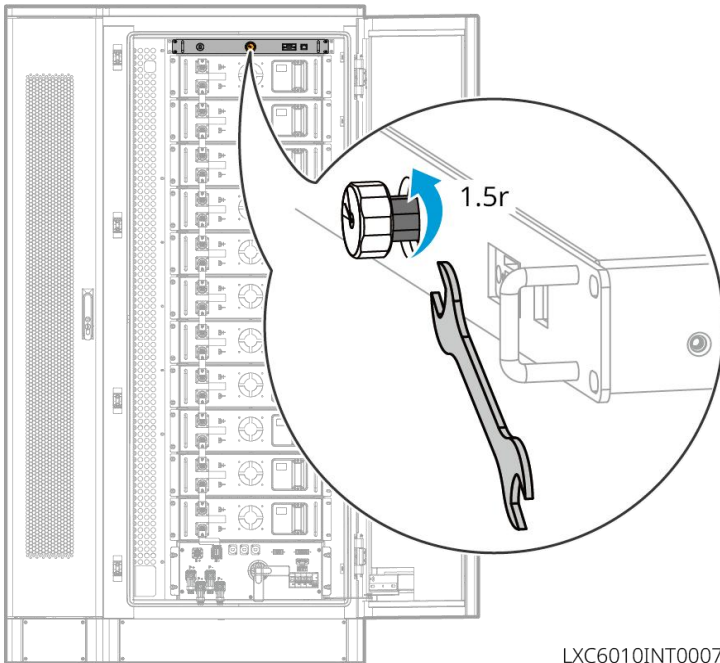

LXC6010INT0007

6.6.1.8 Install the baffle

After the cable connection is completed, the bottom baffle needs to be installed.

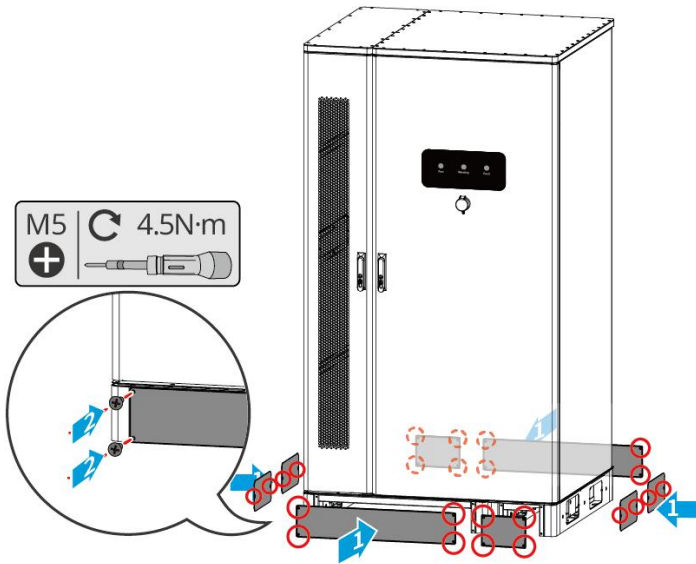

LXC6010INT0008

6.6.2 Compatible with GW61.4-BAT-AC-G10, GW92.1-BAT-AC-G10, GW102.4-BAT-AC-G10, GW112.6-BAT-AC-G10

6.6.2.1 Battery Wiring Hole and System Wiring Introduction

! WARNING

All cut cable routing holes must be sealed with fireproof mud.

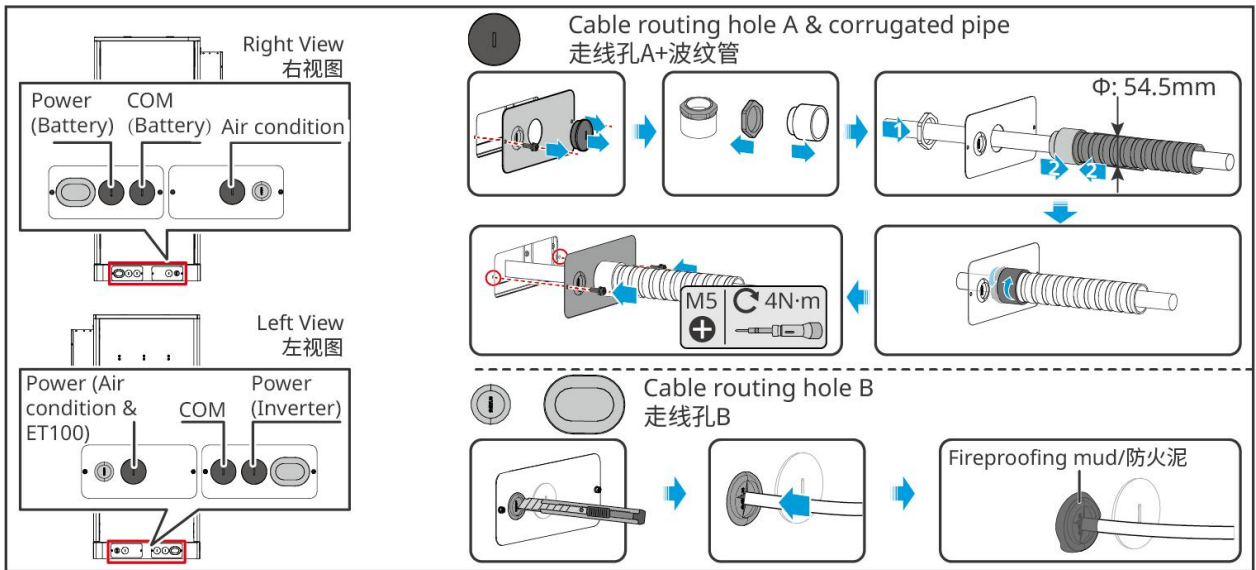

BAT10INT0014

6.6.2.2 Connecting the Power Cable between the Inverter and Battery

Make the inverter power cable

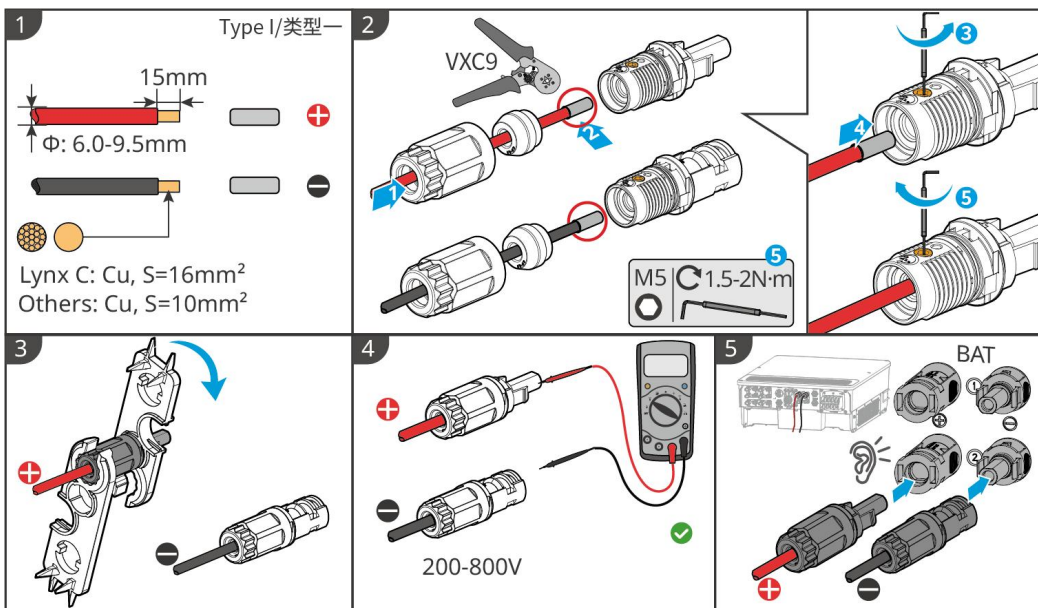

ET3010ELC0031

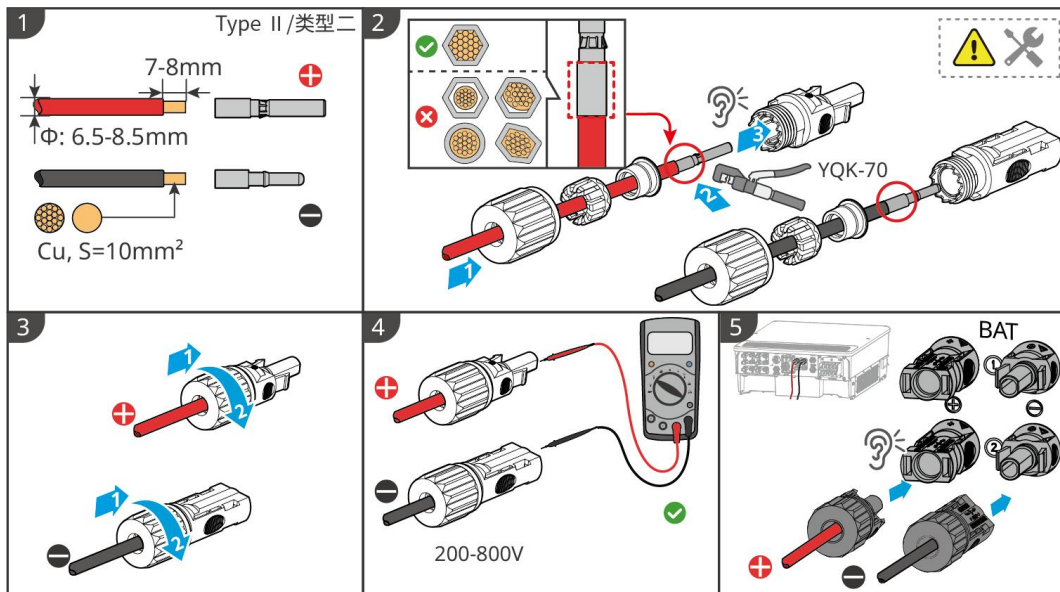

ET3010ELC0032

Make the battery power cable for parallel connections

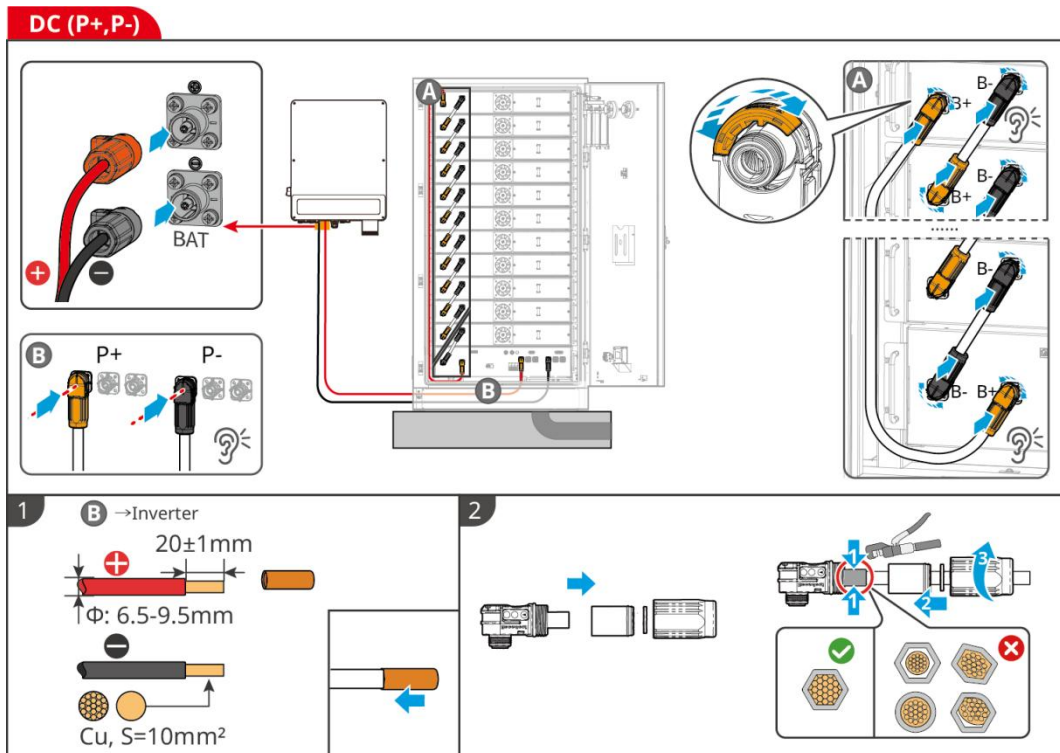

BAT10ELC0011

6.6.2.3 Connection Battery Communication cable

NOTICE

- Battery system is supplied with the box Communication cable. Please use the Communication cable provided with the box.
- The external communication port of the Battery system is pre-connected Terminal resistor at the factory. If you need to connect the Communication cable, please unplug Terminal resistor. For unused port of Communication cable, please retain the Terminal resistor.

Instructions for BMS Communication Connection Between Inverter and Battery:

port	Definition	Instructions
1-3, 6-8	-	-
4	CAN_H	Communicate with Inverter.
5	CAN_L	

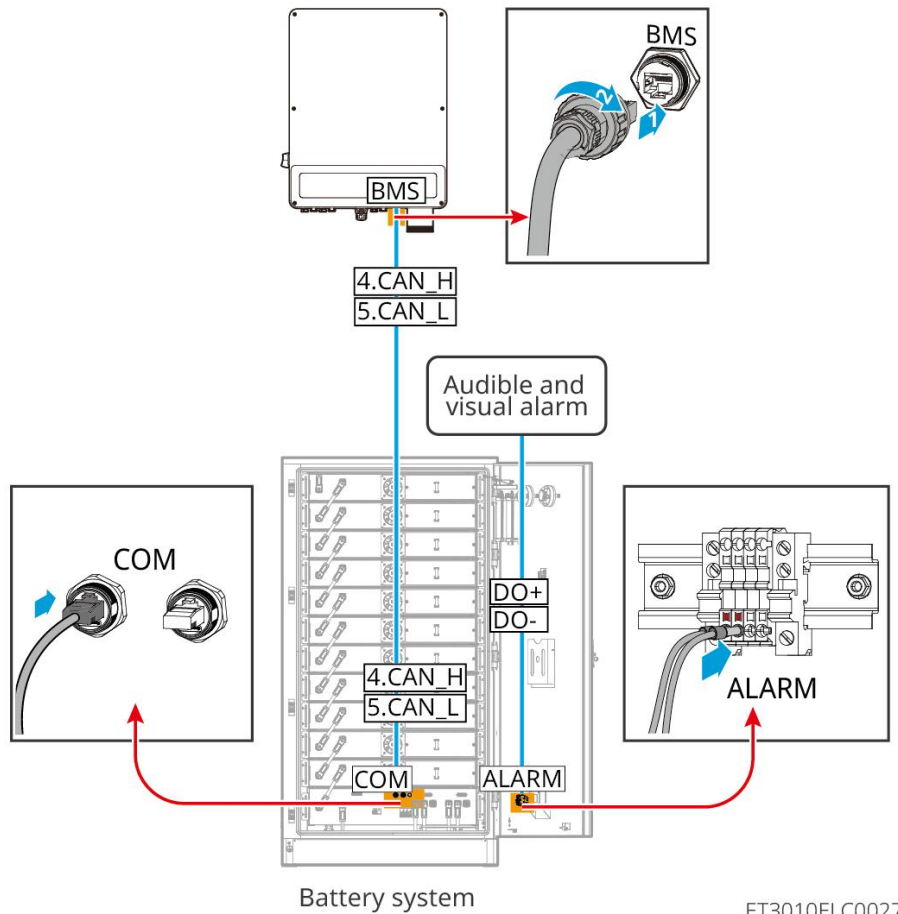

ET3010ELC0027

6.6.2.4 Connect Battery air conditioning cable

Wiring steps:

Step 1 Fabricate the air conditioning cable.

Step 2 Connect the cable to the air conditioning switch on Battery.

Step 3 Connect the cable directly to Main panel or to the BACKUP port of Inverter via Main panel.

NOTICE

Ensure the air conditioner power cord operates at 220V \pm 15% and a rated current of 12A.

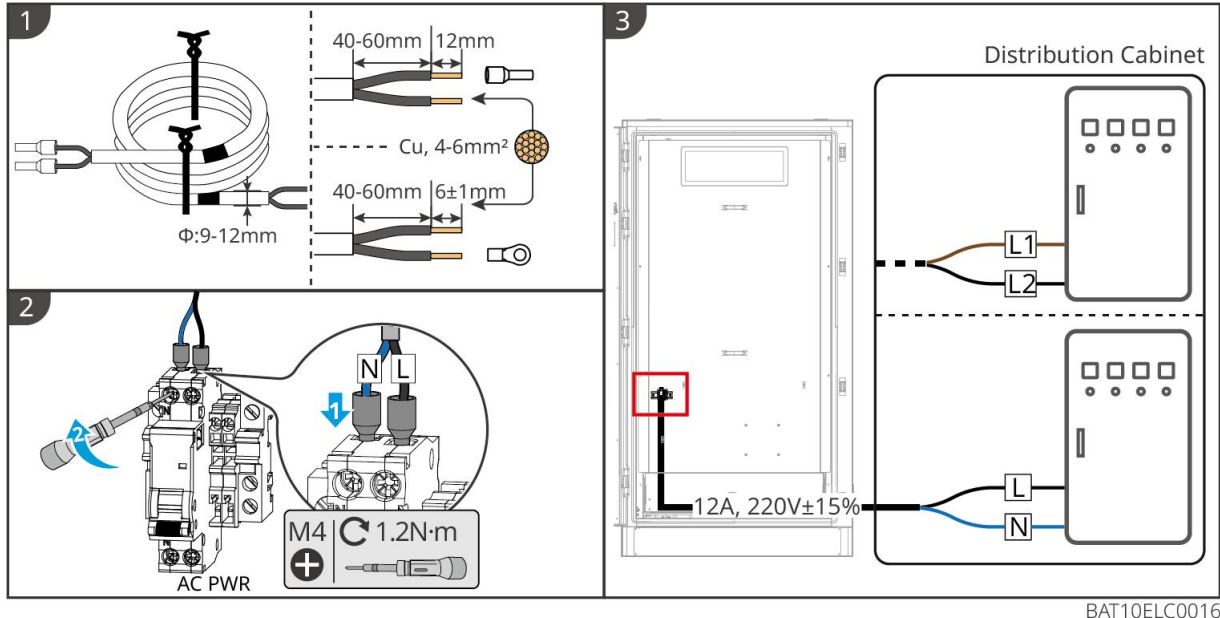

6.6.2.5 Baseplate loose emergency stop switch

After wiring is completed, reinstall the baffle at the bottom of the Battery onto the Battery and rotate the emergency stop switch to the right to release it.

Pedestal installation

安装底板

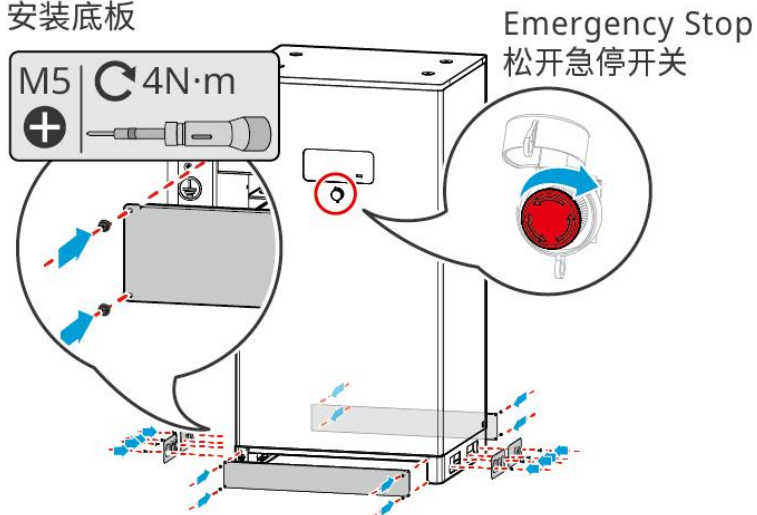

6.7 Connecting the AC Cable



WARNING

- The residual current monitoring unit (RCMU) is integrated into the inverter to avoid the residual current exceeds the limit. The inverter will disconnect the utility grid quickly once it found the residual current exceeds the limit.
- Ensure the AC cables match the AC terminals labeled "L1", "L2", "L3", "N", "PE" when connecting cables. Incorrect cable connections will damage the equipment.
- Ensure that the whole cable cores are inserted into the terminal holes. No part of the cable core can be exposed.
- Ensure that the insulation board is inserted into the AC terminal tightly.
- Ensure that the cables are connected securely. Otherwise it will cause damage to the inverter due to overheat during its operation.

Type I

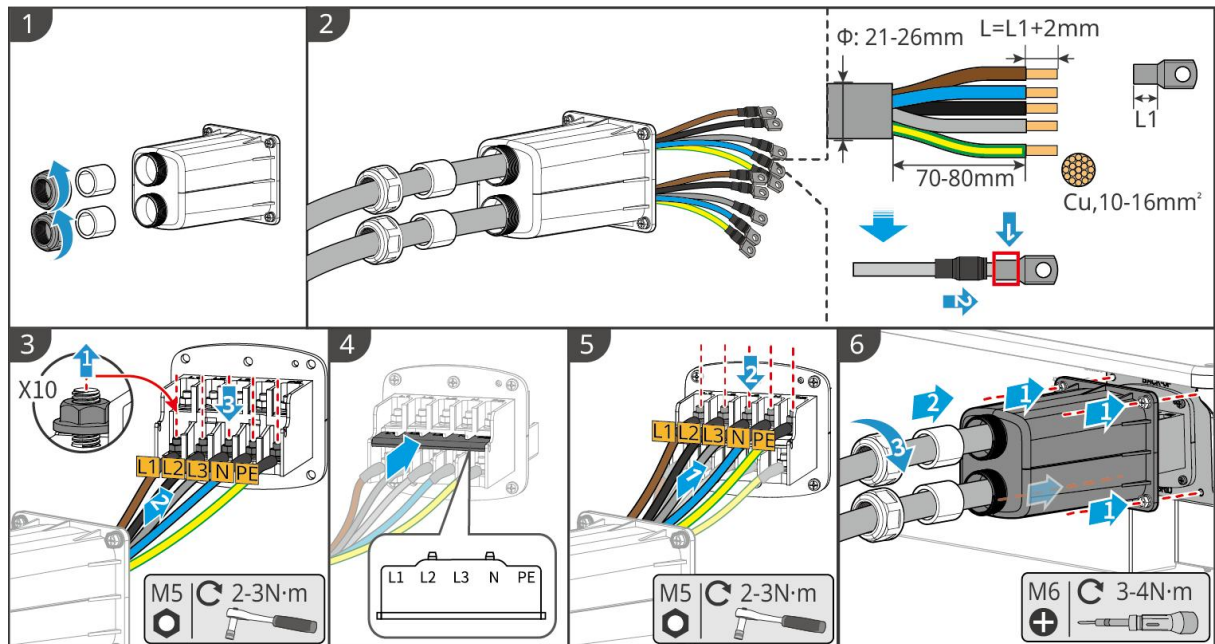

ET3010ELC0006

Type II

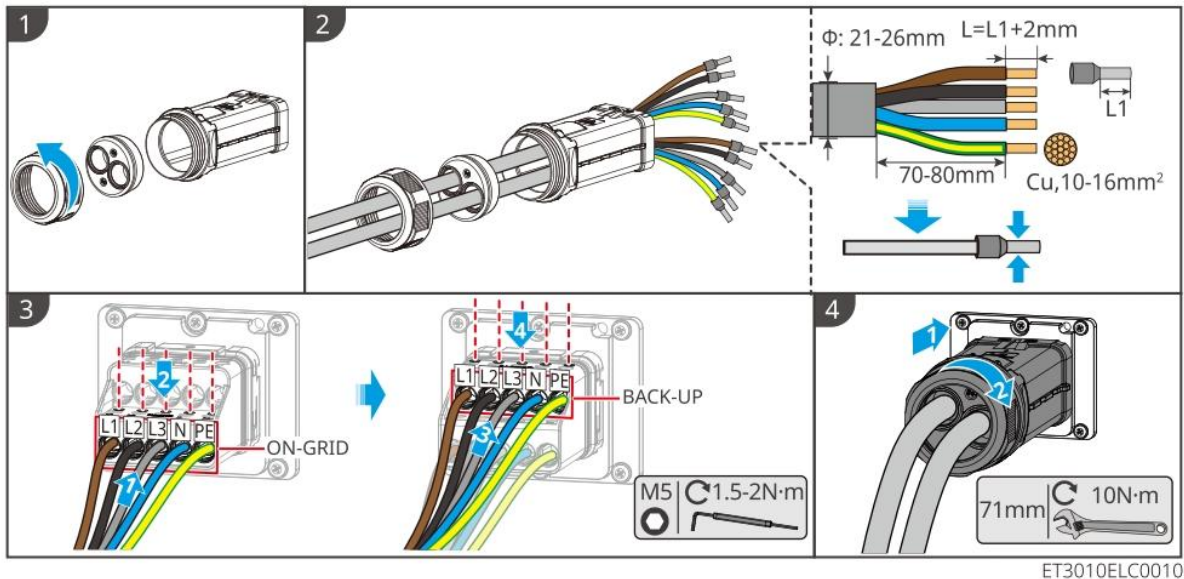

6.8 Connecting the Meter cable

NOTICE

- The smart meter included in the package is intended for a single inverter. Do not connect one smart meter to multiple inverters. Contact the manufacturer for additional smart meters if multiple inverters are connected.
- Ensure that the CT is connected in the correct direction and phase sequences, otherwise the monitoring data will be incorrect.
- Ensure the cables are connected tightly, securely and correctly. Inappropriate wiring may cause poor contacts and damage the equipment.
- In areas at risk of lightning, if the meter cable exceeds 10m and the cables are not wired with grounded metal conduits, you are recommended to use an external lightning protection device.

Wiring of GM3000

NOTICE

- Outer diameter of the AC cable should be smaller than the hole diameter of the CT, so that the AC cable can be routed through the CT.
- To ensure accurate current detection, the CT cable is recommended to be shorter than 30m.
- Do not use network cable as the CT cable, otherwise the smart meter may be damaged due to high current.
- The CTs vary slightly in dimensions and appearance depending on the model, but they are installed and connected in the same way.

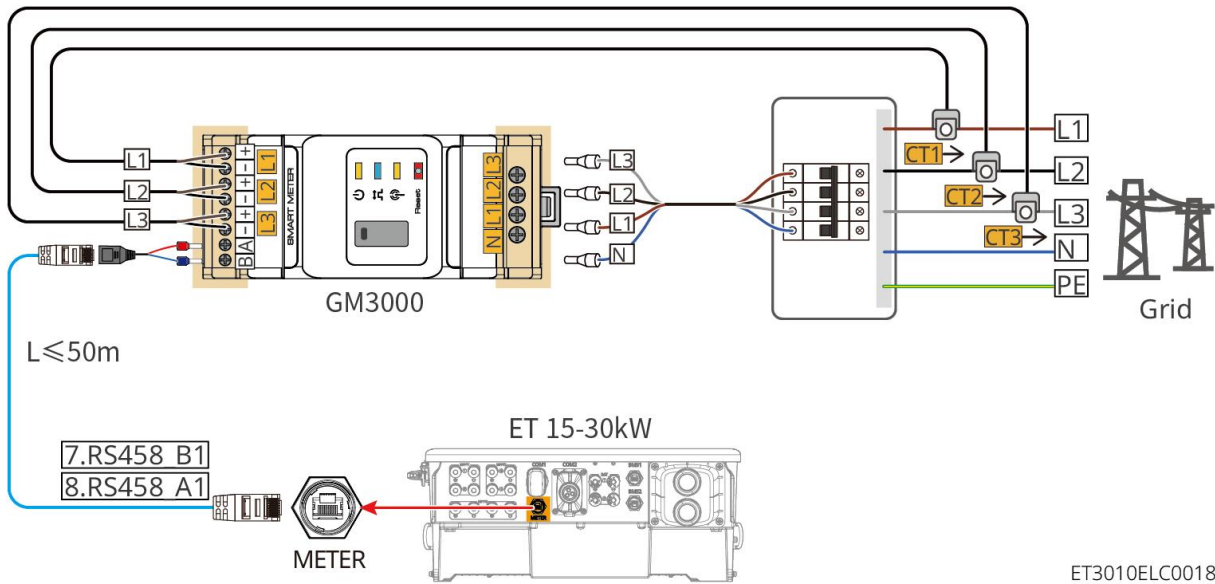

Connection steps

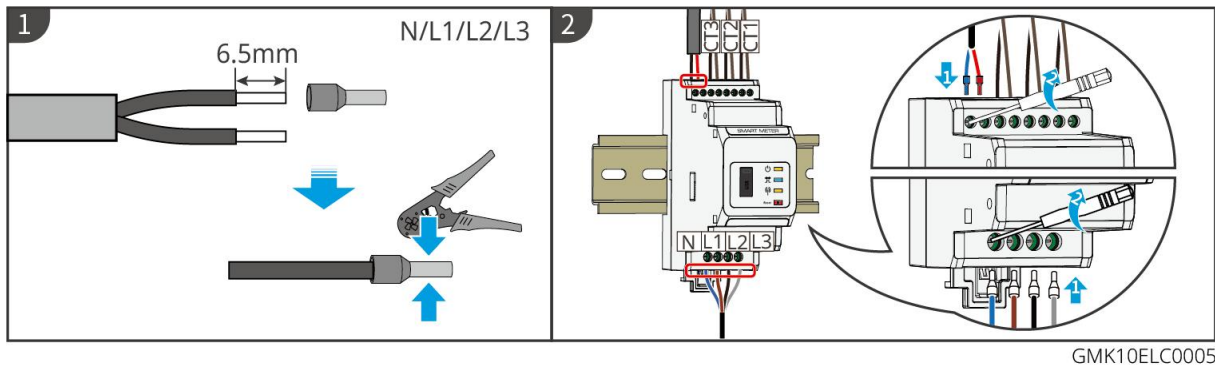

Wiring of GM330 & GMK330

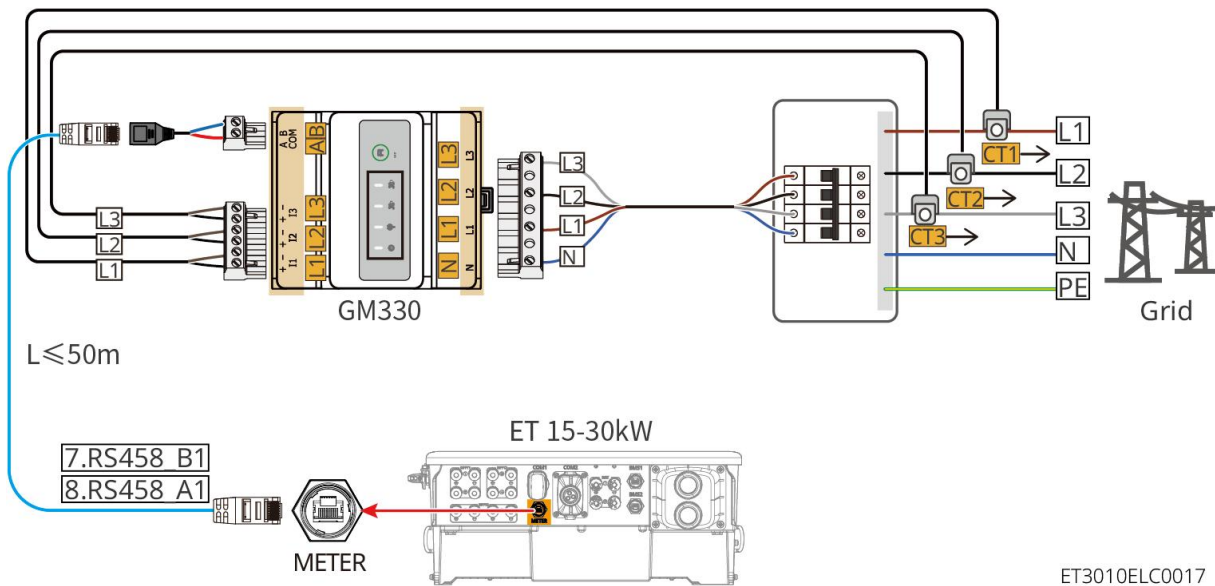

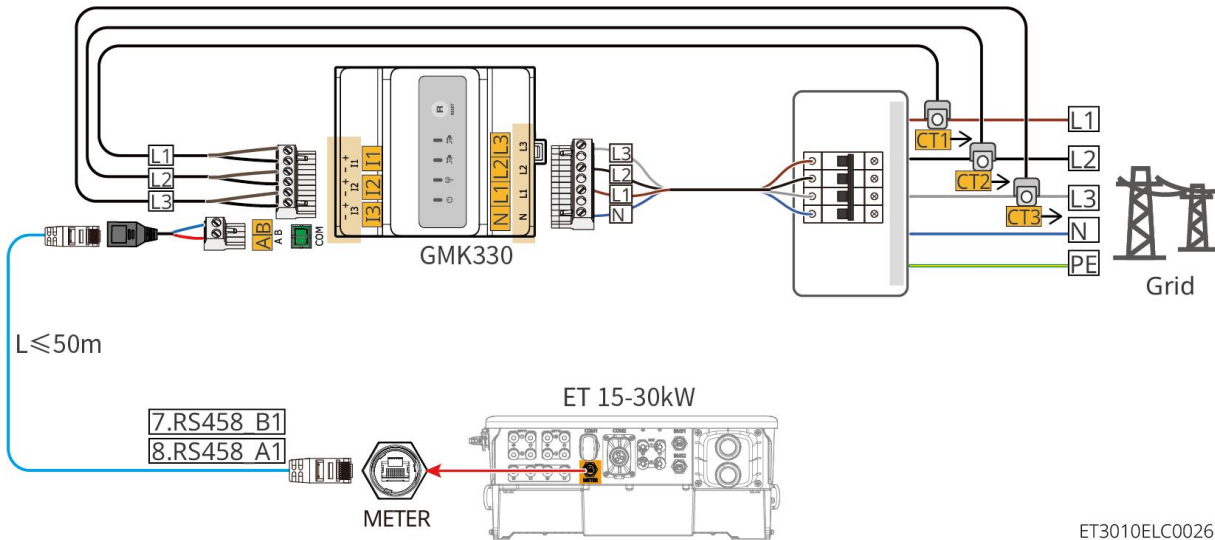

Connection steps

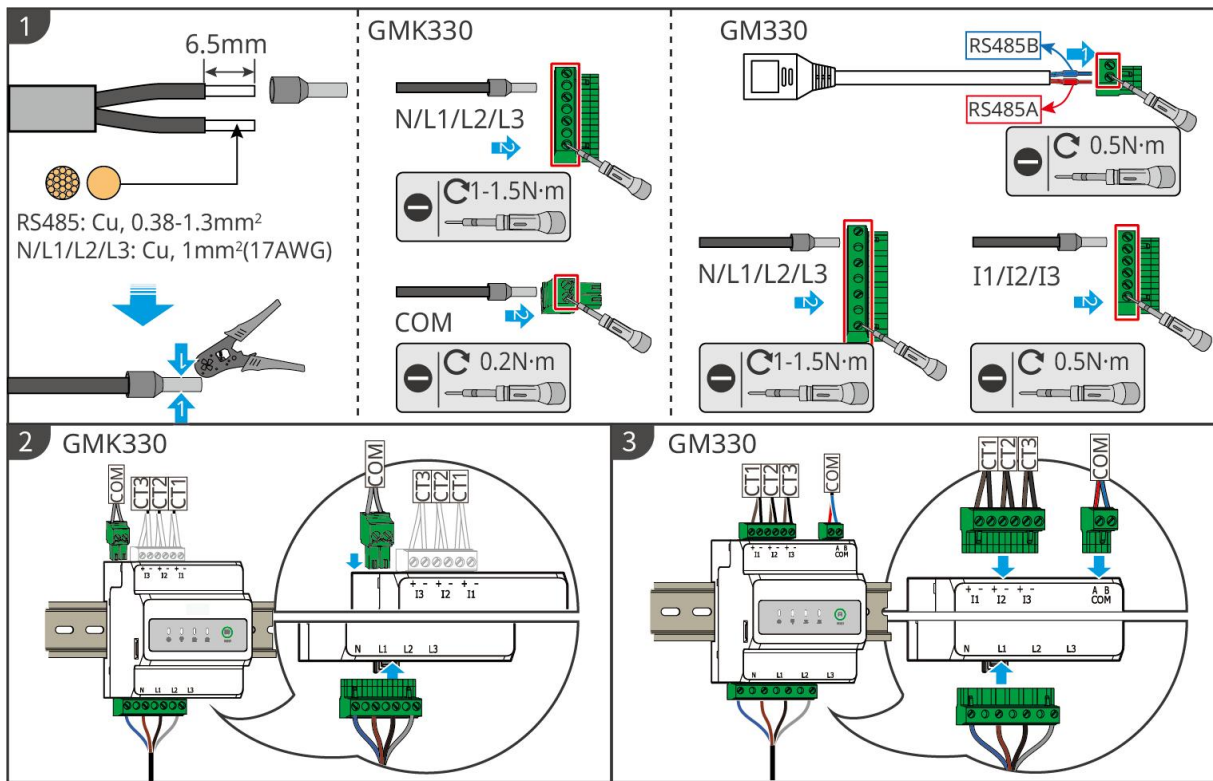

Installing the CT (Type I)

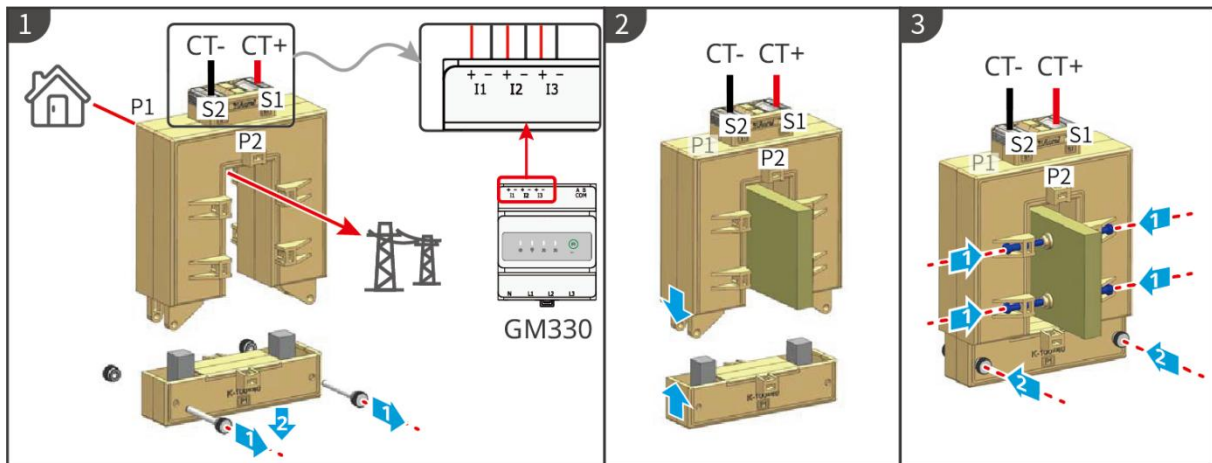

GMK10ELC0006

Installing the CT (Type II)

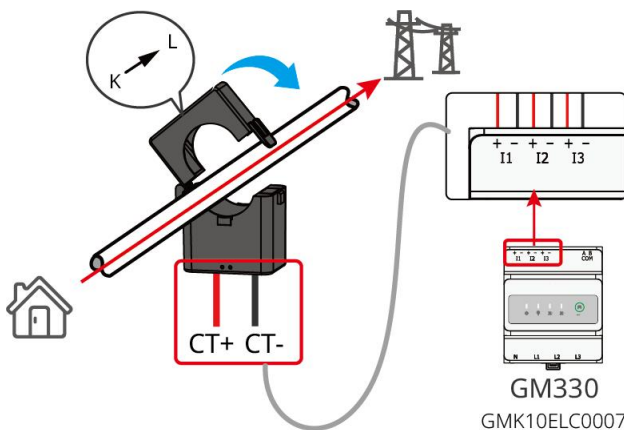

GMK10ELC0007

6.9 Connecting the Inverter Communication Cable

NOTICE

- The communication functions are optional. Connect the cables based on actual needs.
- Enable the DRED, RCR or remote shutdown function via SolarGo App after cable connections.
- If the inverter is not connected to the DRED device or remote shutdown device, do not enable these functions in the SolarGo App, otherwise the inverter cannot be connected to the grid for operation.
- To realize functions such as remote shutdown, DRED and RCR, the communication cable have to be connected to the master inverter. Otherwise, the functions cannot work properly.
- Signals connected to the DO communication port of the inverter should meet the specifications: $\text{Max} \leq 24\text{Vdc}$, 1A.
- EMS communication port: connects with the third party device. The parallel system does not support third-party EMS device connections.
- To ensure waterproof protection, do not remove the waterproof seal of the unused ports.

- Recommended parallel communication cable length: CAT 5E or CAT 6E shielded Ethernet cables $\leq 5\text{m}$; CAT 7E shielded Ethernet cables $\leq 10\text{m}$. Ensure that the parallel communication cable does not exceed 10m, otherwise the communication may be abnormal.
- To use the EnWG 14a, please ensure that the ARM software version is 13.435 or above, and the SolarGo version is 6.0.0 or above.

Communication Descriptions

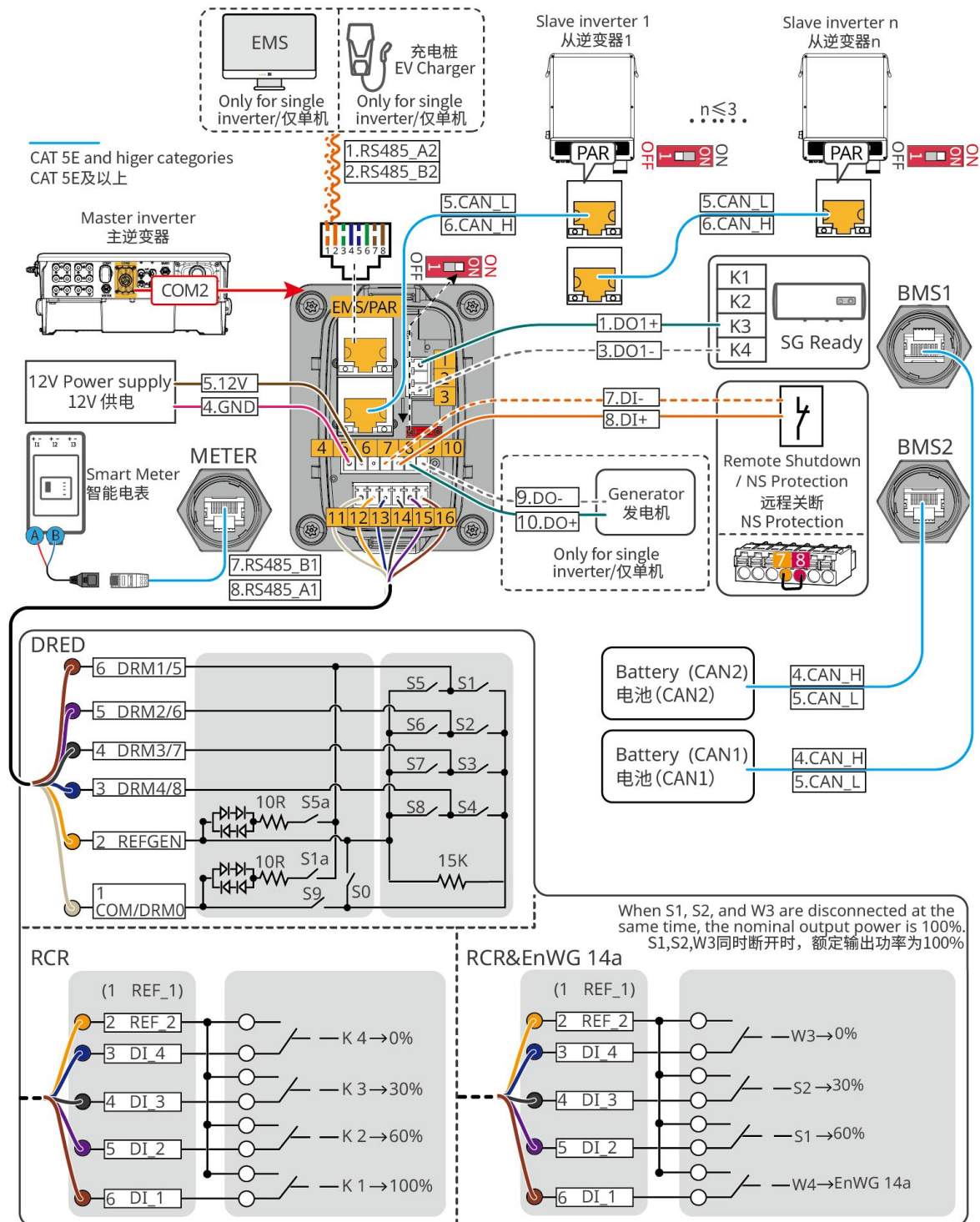

ET3010ELC0012

No.	Function	description
1	Load control (SG Ready)	<ul style="list-style-type: none"> ● Supports dry contact signal connection for functions such as load control. DO contact rating is 12V DC@1A, with NO/COM normally open contacts. ● Supports SG Ready heat pump integration, controlling the heat pump via dry contact signals. ● Supported operating modes: <ul style="list-style-type: none"> ○ Operating Mode 2 (Signal: 0:0): Energy-saving mode, in which the heat pump operates in an energy-efficient manner. ○ Operating Mode 3 (Signal: 0:1): Activation recommendation. In this mode, the heat pump maintains its current operation while increasing hot water storage to accumulate thermal energy.
2	12V power supply	The Inverter provides 12V Power supply port and supports the connection of devices up to 5W. This port features a short-circuit Protection function.
3	Remote Shutdown/NS Protection	<p>Provide signal control for port, control equipment remote shutdown, or implement NS Protection functionality.</p> <p>remote shutdown function:</p> <ul style="list-style-type: none"> ● In the event of an accident, the equipment can be controlled to stop operation. ● The remote shutdown equipment must be a normally closed switch. ● When using the RCR or DRED function, ensure that the remote shutdown device is connected, or the remote shutdown port is short-circuited.
4	Connection of RCR, DRED or EnWG 14a functions port	<ul style="list-style-type: none"> ● RCR (Ripple Control Receiver): Provides RCR signal control for port, meeting the grid dispatch requirements in regions such as Germany. ● DRED (Demand Response Enabling Device): Provides DRED signal control for port, meeting DERD Certification requirements in regions such as Australia. ● EnWG (Energy Industry Act) 14a: All controllable loads must comply with Utility grid emergency dimming. Utility grid operators may temporarily reduce the maximum Utility grid power purchase Power of controllable loads to 4.2 kW.
5	● EMS	● CAN and BUS: Parallel operation, CAN communication

No.	Function	description
	communication or Charge pile Communication Port <ul style="list-style-type: none"> Parallel connection Communication Port 	is used in parallel operation networking to connect other devices; BUS is used to control the on-grid and off-grid status of each unit in parallel operation. <ul style="list-style-type: none"> RS485: Used to connect third-party EMS devices and charging piles. The inverter does not support connecting to third-party EMS devices and charging piles.

Connecting the communication cable

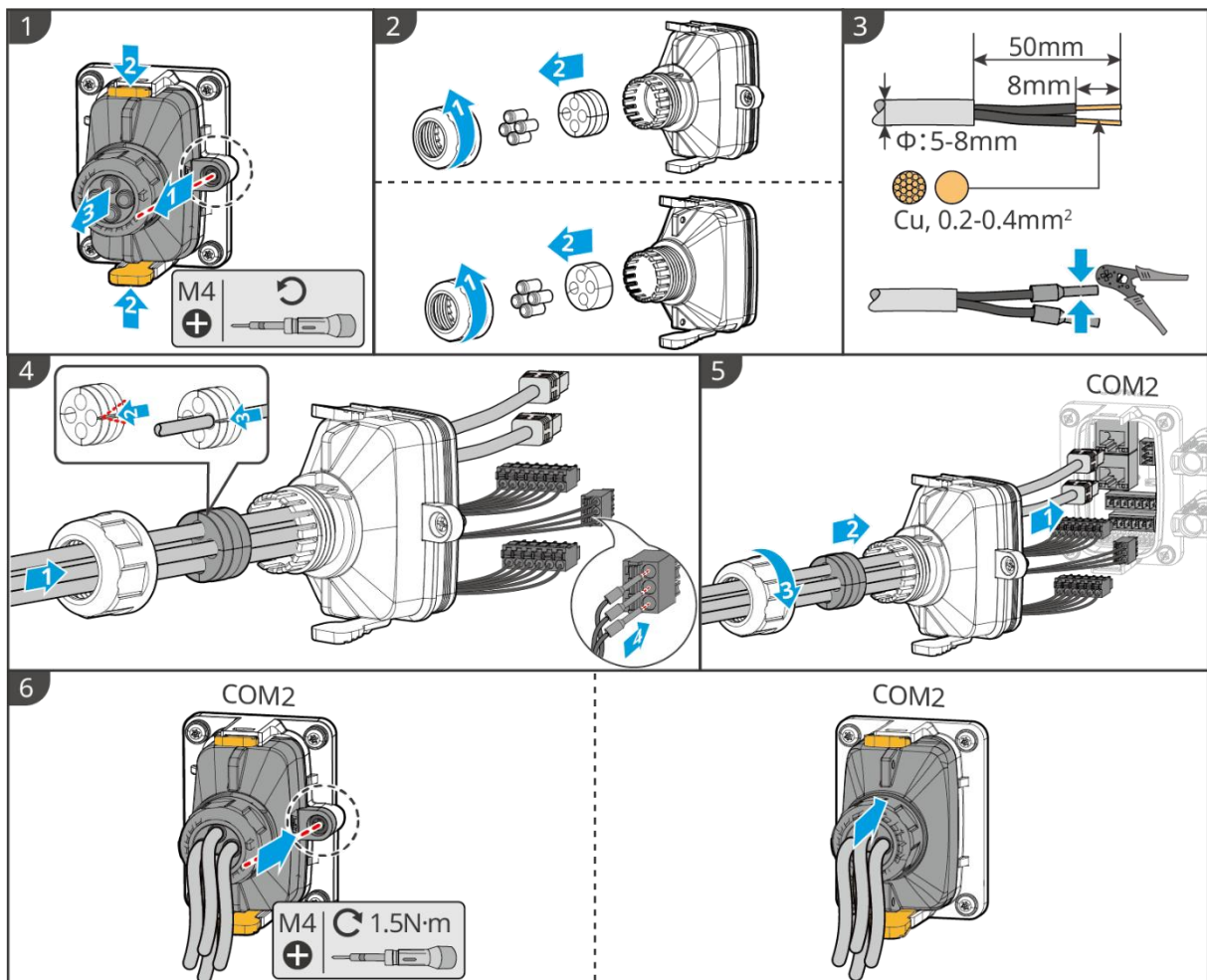

ET3010ELC0009

6.10 Connecting the Smart Dongle

NOTICE

- Plug a smart dongle into the inverter to establish a connection between the inverter and the smartphone or web pages through Bluetooth, WiFi or LAN. Set inverter parameters, check running information and fault information, and observe system status in time via

the smartphone or web pages.

- When multiple inverters are connected in a parallel system, the Ezlink3000 should be installed to the master inverter.
- WiFi-kit, WiFi/LAN Kit-20 or 4G can be used when there is only one inverter.
- Install a WiFi-kit, WiFi/LAN Kit-20, or Ezlink3000 when the inverter is connected to the router through WiFi.
- Install a WiFi/LAN Kit-20 or Ezlink3000 when the inverter is connected to the router through LAN.
- When 4G communication is selected to upload the operation information of the energy storage system to the monitoring platform, LS4G Kit-CN, 4G Kit-CN, 4G Kit-CN-G20 or 4G Kit-CN-G21 can be used. When using LS4G Kit-CN or 4G Kit-CN, you need to use the smart dongle delivered with the inverter to configure the parameters of the energy storage system. After the configuration is completed, replace it with LS4G Kit-CN or 4G Kit-CN for data transmission. When using 4G Kit-CN-G20 or 4G Kit-CN-G21, please use the emitted Bluetooth signal to configure the near-end device.
- The 4G dongle is a LTE single-antenna device, applicable to scenarios with low data transmission rate requirements.
- The built-in SIM card of the 4G smart dongle is a mobile communication card. Please confirm whether the device is installed in an area covered by mobile 4G signals.
- The 4G Kit-CN-G20 or 4G Kit-CN-G21 smart dongle supports the replacement of operator communication cards. If the local mobile signal is not covered, please contact the after-sales service center to replace it with a communication card of another operator.
- After installing the 4G Kit-CN-G20 or 4G Kit-CN-G21, contact the after-sales service center to bind the inverter and the smart dongle. After binding, if you need to install the dongle to other inverters, please contact the after-sales service center to unbind it first.
- To ensure the quality of 4G signal communication, do not install the device indoors or in areas with signal interference of metal.

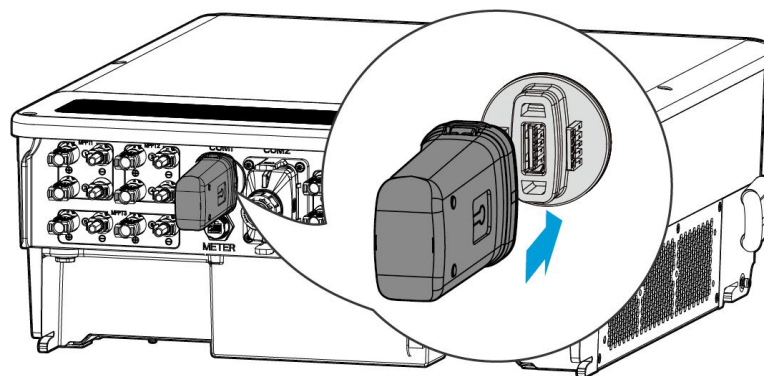

ET3010ELC0010

7 System Commissioning

7.1 Check Before Power ON

No.	Check Item
1	The inverter is firmly installed in a clean place where is well-ventilated and easy to operate.
2	The PE, DC input, AC output, communication cables, and terminal resistors are connected correctly and securely.
3	Cable ties are intact, routed properly and evenly.
4	Unused cable holes are fitted using the waterproof nuts.
5	The used cable holes are sealed.
6	The voltage and frequency at the connection point meet the inverter grid connection requirements.

7.2 Power ON

WARNING

- When multiple Inverter units are connected in parallel, ensure that all Slave inverter AC-side power on operations are completed within one minute after the Master inverter AC-side power on.
- When multiple Battery system are connected in parallel, ensure that all QF2 switches of the Battery system are closed within five minutes.
- When multiple Battery system are connected in parallel, ensure that the SolarGo App correctly displays the number of Battery system clusters before closing QF1, otherwise it may cause damage to the Battery system.

NOTICE

When there is no PV power generation in the photovoltaic system and Utility grid is abnormal, if Inverter fails to operate normally, the Battery black start function can be used to forcibly start Inverter via Battery discharge. Inverter can then enter off-grid mode, with Battery supplying power to the load.

- The black start procedures for GW61.4-BAT-AC-G10, GW92.1-BAT-AC-G10, GW102.4-BAT-AC-G10 and GW112.6-BAT-AC-G10 can be referred to the steps in power off above.
- Other Battery black start procedures are consistent with the power on steps.



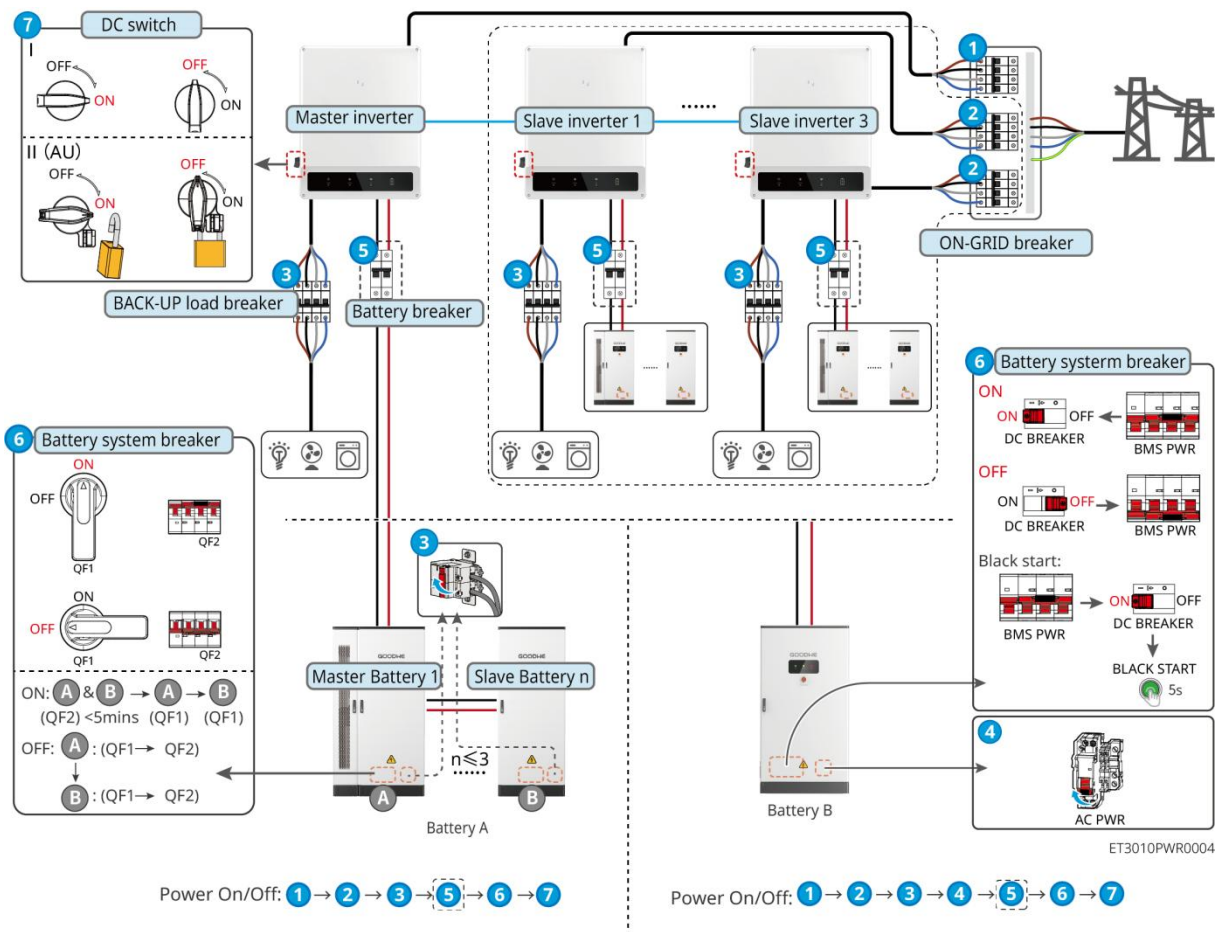













GW61.4-BAT-AC-G10, GW92.1-BAT-AC-G10, GW102.4-BAT-AC-G10, GW112.6-BAT-AC-G10: Before power on operation, ensure that the emergency stop switch of the Battery is in the released state. Release procedure: Rotate the emergency stop switch clockwise.







⑤: Optional in compliance with local laws and regulations.

7.3 Indicators

7.3.1 Inverter Indicators

Indicator	Status	Description
		The inverter is power on and in the standby mode.
		The inverter is starting up and in the self-check mode.
		The inverter is in normal operation under grid-tied or off-grid mode.
		BACK-UP output overload.
		System fault.
		The inverter is powered off.
		The grid is abnormal, and the power supply to the BACK-UP port of the inverter is normal.
		The grid is normal, and the power supply to the BACK-UP port of the inverter is normal.
		The BACK-UP port has no power supply.
		The monitoring module of the inverter is resetting.
		The inverter fails to connect with the communication Termination.
		Communication fault between the communication Termination and Server.
		The monitoring of the inverter operates well.
		The monitoring module of the inverter has not been started yet.











Indicator	Description
	$75\% < SOC \leq 100\%$
	$50\% < SOC \leq 75\%$

	$25\% < SOC \leq 50\%$
	$0\% < SOC \leq 25\%$
	No battery connected.



Indicator light blinking during battery discharging: for example, when the battery SOC is between 25% and 50%, the light at the 50% position blinks.











7.3.2 Battery Indicators

- **GW60KWH-D-10, GW60KWH-D-10 (Extension)**

Indicator	Status	Description
 operation		Green light steady on: The device is operating normally.
		Green light flashes once: Battery operates normally, no communication with Inverter.
		Green light flashes twice: Device Standby in progress
		Green light off, yellow light steady on: Equipment alarm The green light goes out, Steady red: Equipment fault Green light, yellow light, and red light are all off: the device is not power on.
 WARNING		Always On: Equipment Alarm
		Extinguish: No alarms on the equipment
 fault		Constant On: Equipment fault
		Extinguish: The equipment has no fault.



- **GW61.4-BAT-AC-G10, GW92.1-BAT-AC-G10, GW102.4-BAT-AC-G10, GW112.6-BAT-AC-G10**

Indicator	Status	Description
 Run		Green light steady on: The device is operating normally.
		Single green flash: Battery operating normally, no communication with Inverter





		Green light flashes twice: Device Standby in progress
		Green light off, yellow light steady on: Equipment alarm The green light goes out, Steady red: Device fault Green light, yellow light, and red light are all off: The device is not power on.
 Warning		Always On: Equipment Alarm
		Extinguish: No alarms on the equipment
 Fault		Constant On: Equipment fault
		Extinguish: The equipment has no fault.
		Red single flash: Dormant (undervoltage)
		Red light flashing twice: SN abnormal

7.3.3 Smart Meter Indicator

GM3000



Indicator	Status	Description
Power indicator 	Steady on	The smart meter is power on.
	Off	The meter has been powered off.
Importing or exporting indicator 	Steady on	Importing from the utility grid.
	Blinks	Exporting to the grid.
Communication indicator 	Blinks	Communication is OK.
	Blinking 5 times	<ul style="list-style-type: none"> ● Press the Reset button for less than 3 seconds: Reset the meter. ● Press the Reset button for 5 seconds: Reset the meter parameters to factory settings. ● Press the Reset button for more than 10 seconds: Reset the meter parameters to factory settings, and reset the energy data to zero.
	Off	Meter has no communication connection.

GM330 & GMK330

Indicator	Status	Description
Power light 	Steady on	Power on, no RS485 communication.
	Blinking	Power on, RS485 communication works properly.
	Off	Power off.
Communication light 	Off	Reserved.
	Blinking	Press the Reset button for more than 5 seconds, power light, buying or selling electricity indicator light flash: Reset the meter.
Buying or selling electricity indicator light 	Steady on	Purchasing from the utility grid.
	Blinking	Selling to the utility grid.
	Off	No purchasing or selling.
Buying or selling electricity indicator light(Only for GMK360) 	Steady on	Purchasing from the utility grid.
	Blinking	Selling to the utility grid.
	Off	No purchasing or selling.



7.3.4 Smart Dongle Indicator

Wi-Fi Kit









Indicator	Color	Status	Description
Power indicator 	Green	ON	The Wi-Fi Kit is powered on.
		Off	The Wi-Fi Kit is restarting or not powered on.
Communication indicator 	Blue	ON	WiFi is connected to router.
		Off	<ul style="list-style-type: none"> ● Improper communication on Wi-Fi Kit. ● The kit is restarting.

LS4G Kit-CN、 4G Kit-CN

Indicator	Color	Status	Description
Power LED		ON	The module is secured and power on.

	green	Off	Module not tightened or not power on
Communication light 	blue	slow blinking (0.2s on, 1.8s off)	<ul style="list-style-type: none"> ● Inverter Communication Light 2 Flashes: Dialing, Network Searching Status ● Inverter Communication light 4 flashes: No flow causing connection to cloud failed
		slow blinking (1.8s on, 0.2s off)	<ul style="list-style-type: none"> ● Inverter Communication light 2 flashes: Dialing successful ● Inverter Communication light steady on: Cloud connection successful ● Inverter Communication light 4 flashes: No traffic causing connection to cloud failure
		fast blinking (0.125s on, 0.125s off)	Inverter communicates with the cloud through the module
		0.2On for 8 seconds, off for 8 seconds	No Installation SIM card or SIM card poor contact

4G Kit-CN-G20 & 4G Kit-CN-G21

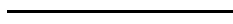









indicator	Status	Instructions
Power indicator light 		Constant light: Smart dongle has been power on.
		Extinguish: Smart dongle not power on.
Communication light 		Constant on: Smart dongle is connected to Server, communication is normal.
		Double flashing: Smart dongle is not connected to the base station.
		Four flashes: Smart dongle is connected to the base station but not connected to Server.
		Six flashes: Communication between Smart dongle and Inverter is disconnected.
		Extinguished: Smart dongle software reset in progress or not power on.

Button	description
Reload	Press and hold for 0.5~3 seconds, the Smart dongle will restart.
	Press and hold for 6~20 seconds, the Smart dongle will restore factory settings.

WiFi/LAN Kit-20

NOTICE





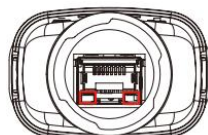

- Double click the Reload button to turn on the bluetooth signal, and the indicator turns to single flash. Connect to the SolarGo app within 5 minutes, or Bluetooth will automatically turn off.
- The indicator only turns to single flash after double clicking the Reload button.

Indicator	Status	Description
Power indicator 		Steady on: The smart dongle has been powered on.
		Off: The smart dongle is not powered on.
Communication indicator 		Steady on: The WiFi or LAN communication is working well.
		Single blink: The Bluetooth signal is on and waiting for connection to the app.
		Double blinks: The smart dongle is not connected to the router.
		Four blinks: The smart dongle is communicating normally with the router, but not connected to the server.
		Six blinks: The smart dongle is identifying the connected device.
		Off: The software of the smart dongle is resetting or is not powered on.

Indicator	Color	Status	Description
Communication indicator in LAN Port 	Green	Steady on	The connection of the wired network at 100Mbps is normal.
		Off	<ul style="list-style-type: none"> ● The Ethernet cable is not connected. ● The connection of the wired network at 100Mbps is abnormal. ● The connection of the wired network at 100Mbps is normal.
	Yellow	Steady on	The connection of the wired network at 10Mbps is normal, but no communication data is received or

			transmitted.
		Blinks	The communication data is being transmitted or received.
		Off	The Ethernet cable is not connected.
Button		Description	
Reload		Press 0.5 to 3 seconds to reset the Smart Dongle.	
		Press 6 to 20 seconds to restore the Smart Dongle to factory settings.	
		Quick double click to turn on the Bluetooth signal (lasts only 5 minutes).	

Ezlink3000

Indicator/ silkscreen	Color	Status	Description
Power indicator 	Blue		Blink = The Ezlink is working properly.
			OFF = The Ezlink is powered off.
Communication indicator 	Green		ON = The Ezlink is connected to the server.
			Blink 2 = The Ezlink is not connected to the router.
			Blink 4 = The Ezlink is connected to the router, but not connected to the server.
RELOAD	-	-	<ul style="list-style-type: none"> ● Short press for 3s to restart the Ezlink. ● Long press for 3-10s to restore factory settings.

7.4 Closing the Cabinet Door

- GW60KWH-D-10, GW60KWH-D-10 (Extension)

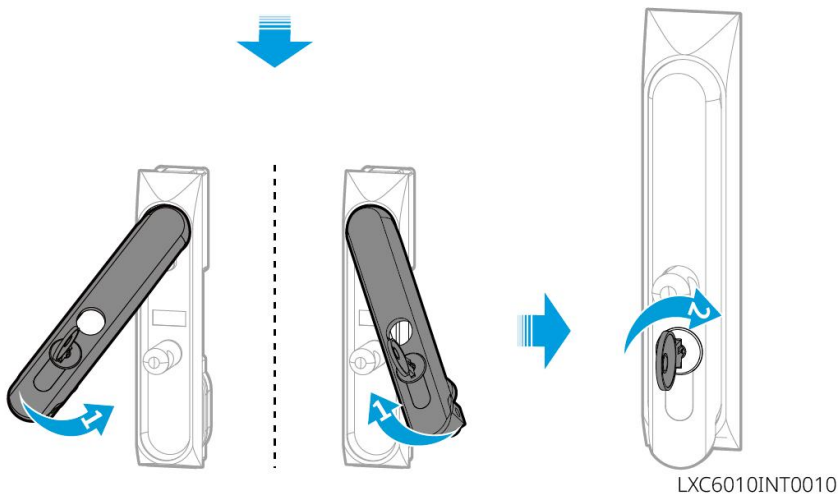
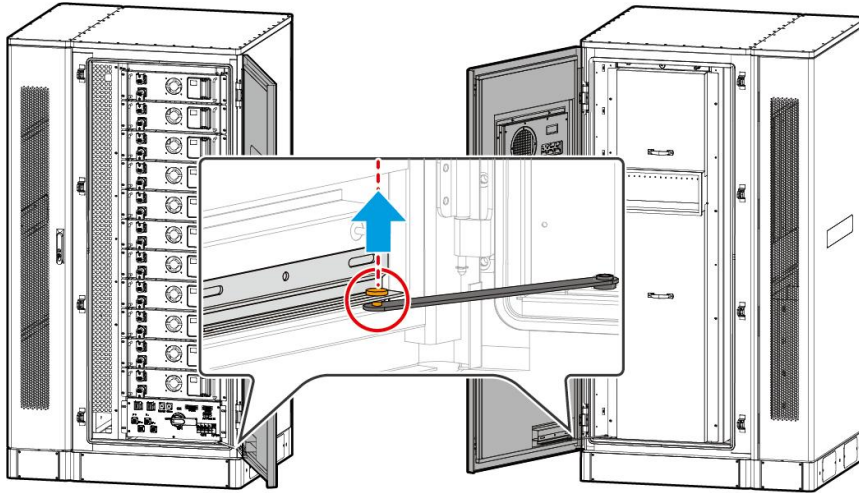

- GW61.4-BAT-AC-G10, GW92.1-BAT-AC-G10, GW102.4-BAT-AC-G10, GW112.6-BAT-AC-G10

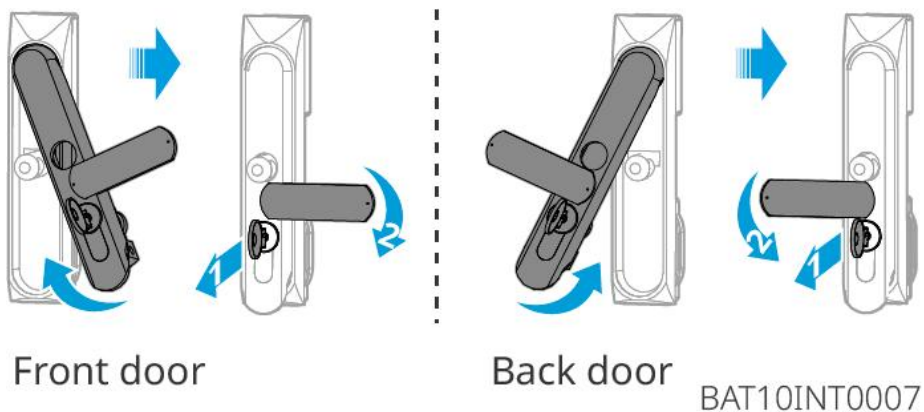

8 Quick System Commissioning

8.1 Downloading the App

Make sure that the mobile phone meets the following requirements:

- Mobile phone operating system: Android 4.3 or later, iOS 9.0 or later.
- The mobile phone can access the Internet.
- The mobile phone supports WLAN or Bluetooth.

Method 1: Search SolarGo in Google Play (Android) or App Store (iOS) to download and install the app.

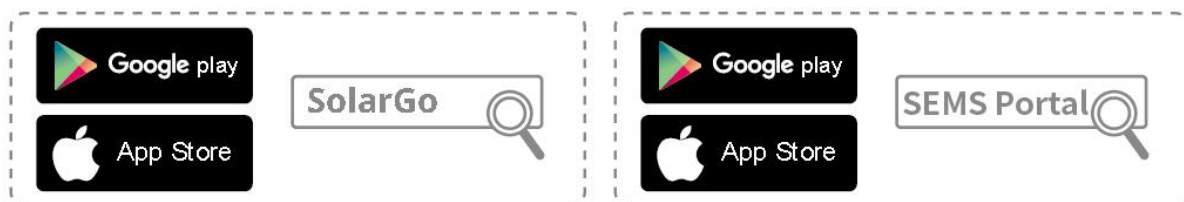

Method 2: Scan the QR code below to download and install the app.

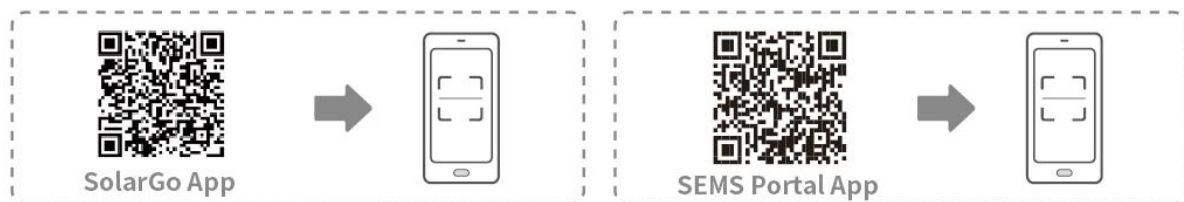

8.2 Connecting the Inverter

NOTICE

The device name varies depending on the inverter model or smart dongle type:

- Wi-Fi Kit: Solar-WiFi***
- Bluetooth module: Solar-BLE***
- WiFi/LAN Kit-20: WLA-***
- Ezlink3000: CCM-BLE***; CCM-***; ***
- 4G Kit-CN-G20 or 4G Kit-CN-G21: GSA-*** or GSB-***

*** is the inverter serial number*

Connecting the inverter via Bluetooth

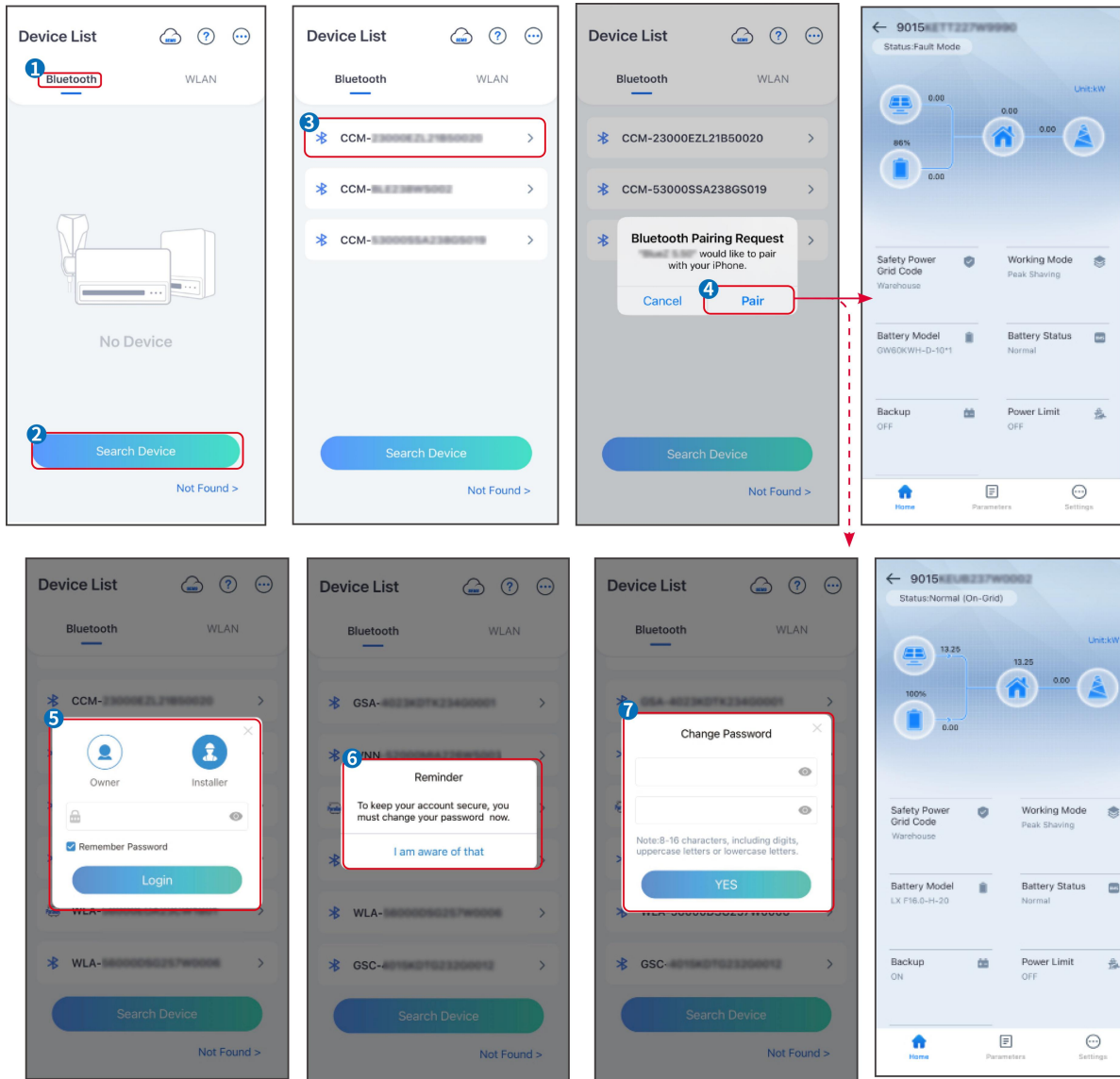

SLG00CON001

Connecting the inverter via WiFi

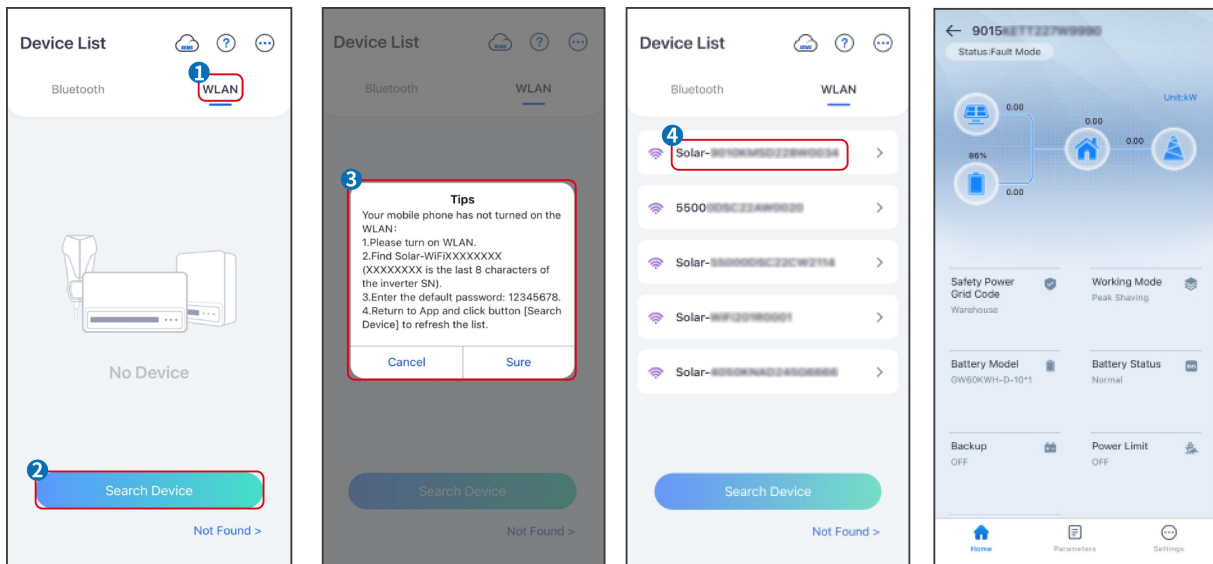

SLG00CON002

8.3 Communication Settings

NOTICE

The communication configuration interface may vary depending on the type of smart dongle connected to the inverter. Please refer to the actual interface for accurate information.

Step 1 Tap **Home** > **Settings** > **Communication Configuration** > **WLAN/LAN** to set the parameters.

Step 2 Configure the WLAN or LAN network based on the actual situation.

No.	Name/Icon	Description
1	Network Name	Only for WLAN. Select WiFi based on the actual connecting.
2	Password	Only for WLAN. WiFi password for the actual connected network.
3	DHCP	<ul style="list-style-type: none"> ● Enable DHCP if the router is in Dynamic IP mode. ● Disable DHCP when a switch is used or the router is in static IP mode.
4	IP address	<ul style="list-style-type: none"> ● Do not configure the parameters when DHCP is enabled. ● Configure the parameters according to the router or switch information when DHCP is disabled.
5	Subnet Mask	
6	Gateway Address	
7	DNS Server	

8.4 Quick Settings

NOTICE

- The parameters will be configured automatically after selecting the safety country/region, including overvoltage protection, undervoltage protection, overfrequency protection, underfrequency protection, voltage/frequency connection protection, cosφ curve, Q(U) curve, P(U) curve, FP curve, HVRT, LVRT, etc.
- The power generation efficiency varies in different working modes. Set the working mode according to the local requirements and situation.

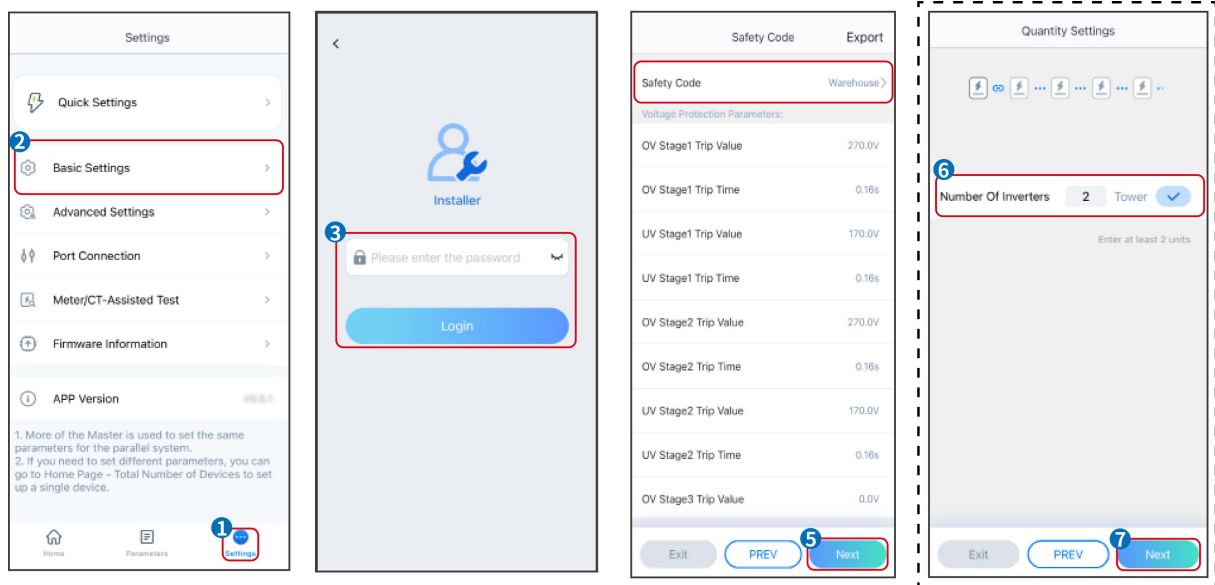

SLG00CON003

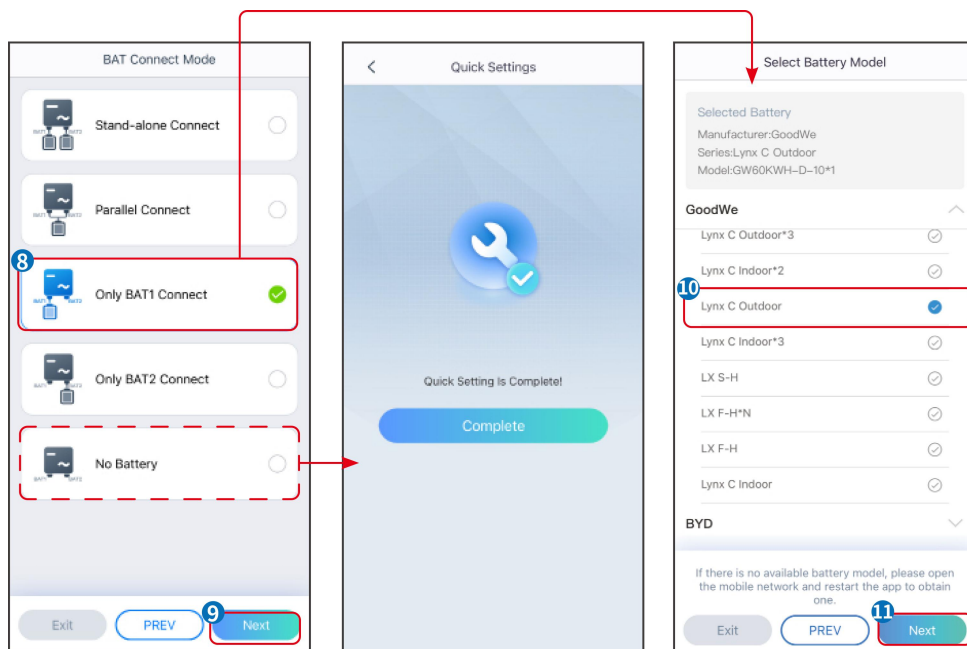

SLG00CON004

Parameters	Description
Safety Code	Select safety country accordingly.
Quantity Settings	In parallel scenarios, set the number of inverters in the parallel system based on actual situation.
BAT Connect Mode	Select the actual mode in which the battery is connected to the inverter. No need to set the battery model and working mode if there is no battery is connected. The system will work in self-use mode by default.
Select Battery Model	Select the actual battery model.
Working Mode	Set the working mode based on actual needs. Supports: Peakshaving mode and Self-use mode.

The app interface is as following when Self-use mode is selected. Enter Advanced Settings to set the detailed working mode and related parameters.

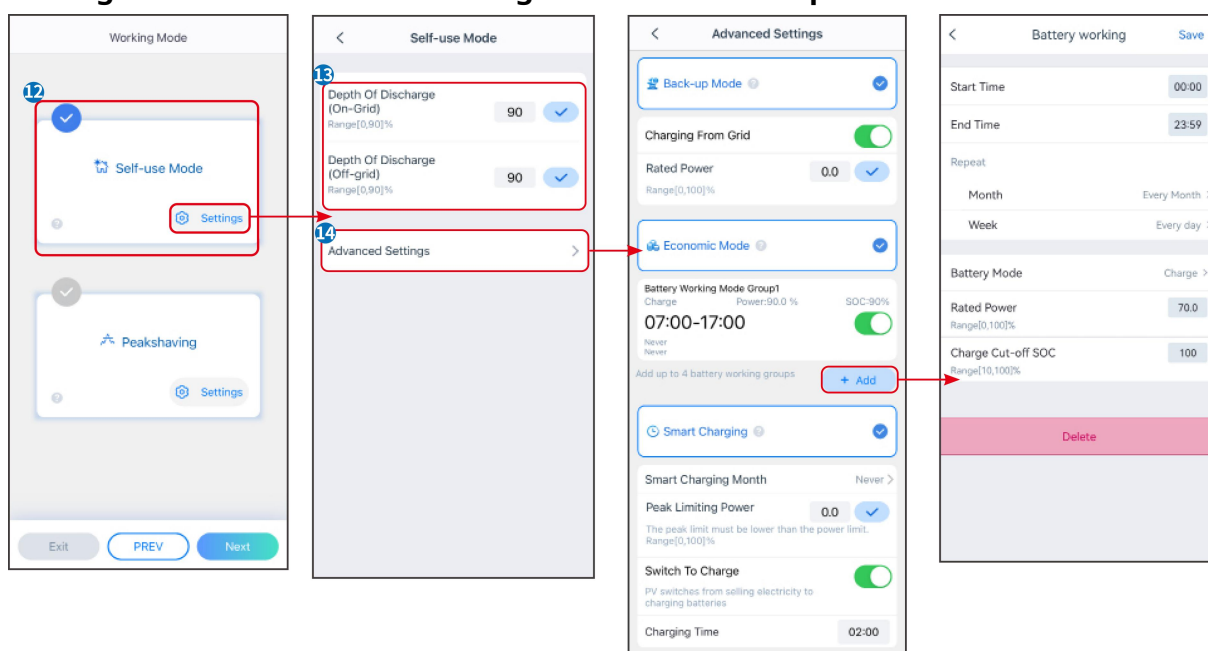

SLG00CON0005

Parameters	Description
Self-use mode: based on the self-use mode, Back-up mode, Economic mode, and Smart charging can be enabled at the same time, and the inverter will automatically select the working mode. Working priority: Back-up mode> Economic mode >Smart charging	
Depth Of Discharge (On-Grid)	The maximum depth of discharge of the battery when the system is working on-grid.
Depth Of Discharge (Off-grid)	The maximum depth of discharge of the battery when the system is working off-grid.
Back-up mode	

Charging From Grid	Enable Charging From Grid to allow power purchasing from the utility grid.
Rated Power	The percentage of the purchasing power to the rated power of the inverter.
Economic mode	
Start Time	Within the Start Time and End Time, the battery is charged or discharged according to the set Battery Mode as well as the Rated Power.
End Time	
Battery Mode	Set the Battery Mode to Charging or Discharging accordingly.
Rated Power	The percentage of the charging/discharging power to the rated power of the inverter.
Charge Cut-off SOC	The battery stop charging/discharging once the battery SOC reaches Charge Cut-off SOC.
Smart charging	
Smart Charging Month	Set the smart charging months. More than one month can be set.
Peak Limiting Power	Set the Peak Limiting Power in compliance with local laws and regulations. The Peak Limiting Power shall be lower than the output power limit specified by local requirements.
Switch to Charge	During charging time, the PV power will charge the battery.

The app interface is as following when Peakshaving mode is selected.

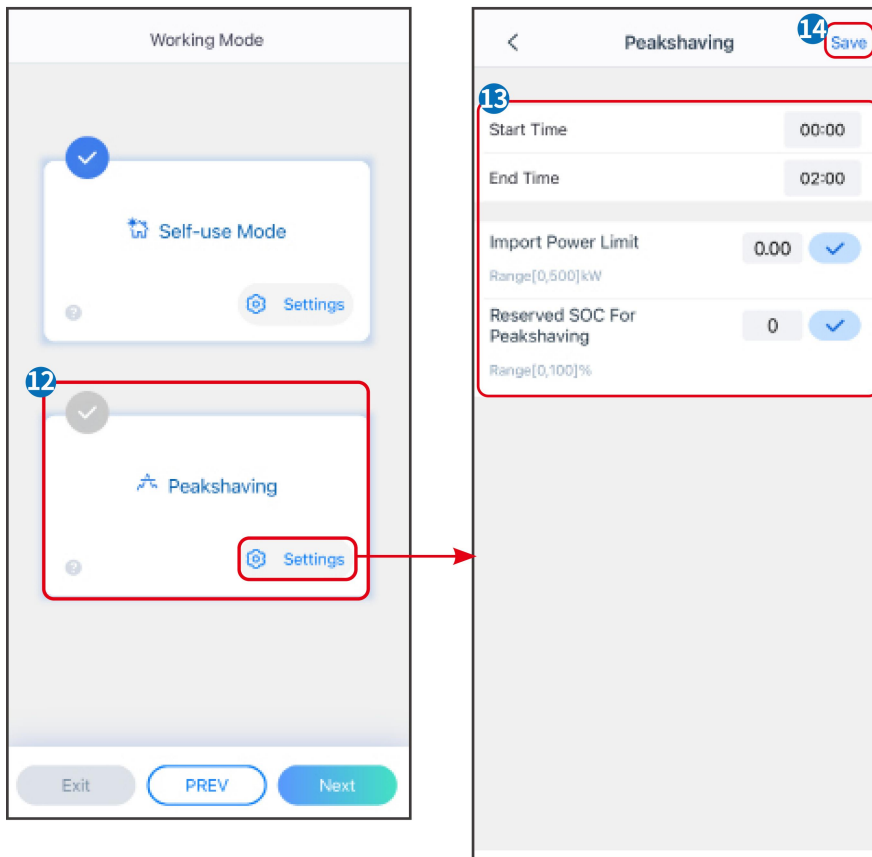

SLG00CON0006

Parameters	Description
Peakshaving	
Start Time	The utility grid will charge the battery between Start Time and End Time if the load power consumption do not exceed the power quota. Otherwise, only PV power can be used to charge the battery.
End Time	
Import Power Limit	Set the maximum power limit allowed purchasing from the grid. When the loads consume power exceed the sum of the power generated in the PV system and Import Power Limit, the excess power will be made up by the battery.
Reserved SOC For Peakshaving	In Peak Shaving mode, the battery SOC should be lower than Reserved SOC For Peakshaving. Once the battery SOC is higher than Reserved SOC For Peakshaving, the peak shaving mode fails.

Tap Complete to complete the settings, restart the equipment following the prompts.

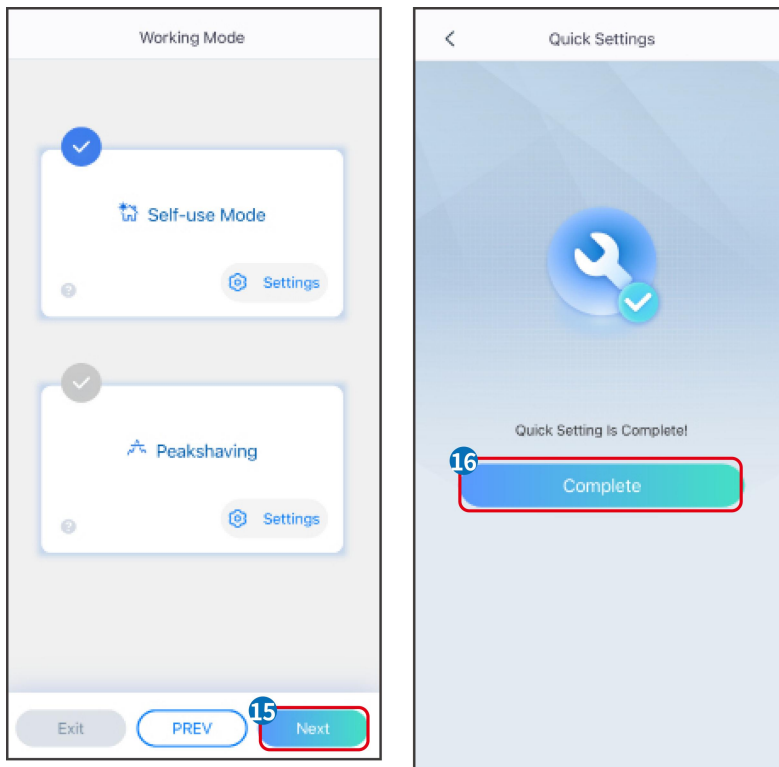

SLG00CON0007

8.5 Creating Power Plants

NOTICE

Login to the SEMS Portal app using the account and password before creating power plants. If you have any questions, refer to the Plant Monitoring section.

Step 1: Enter the Create Plant page.

Step 2: Read the instructions and fill in the requested plant information based on actual situation. (* refers to the mandatory items)

Step 3: Follow the prompts to add devices and create the plant.

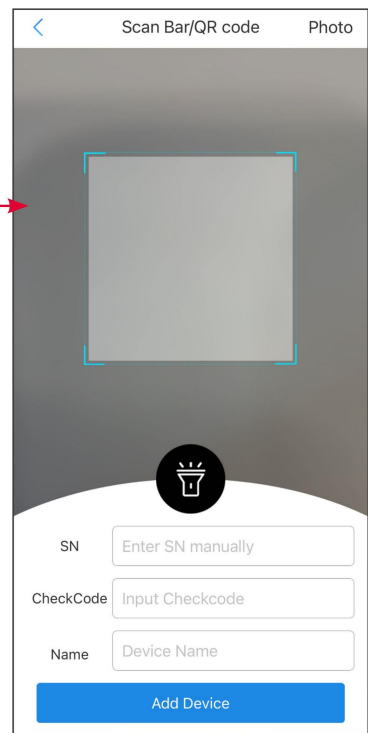
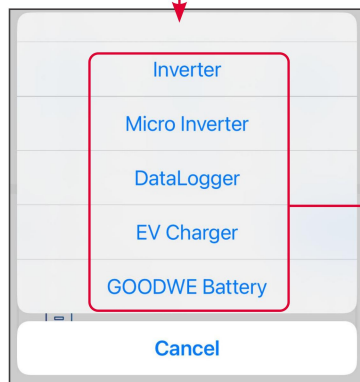
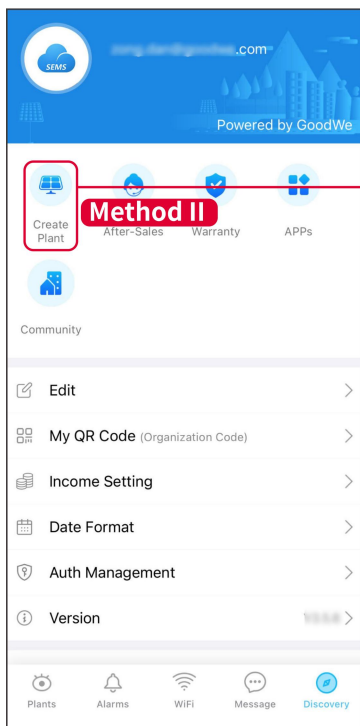
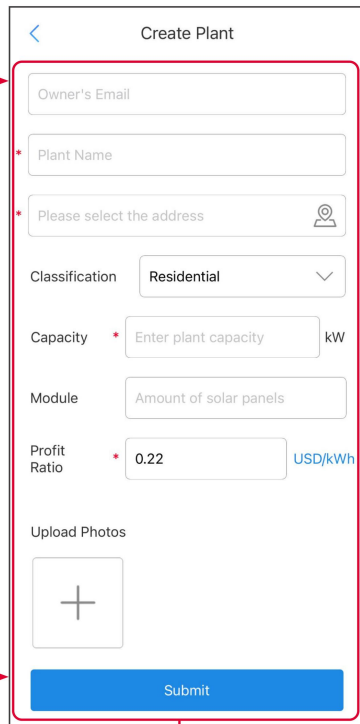
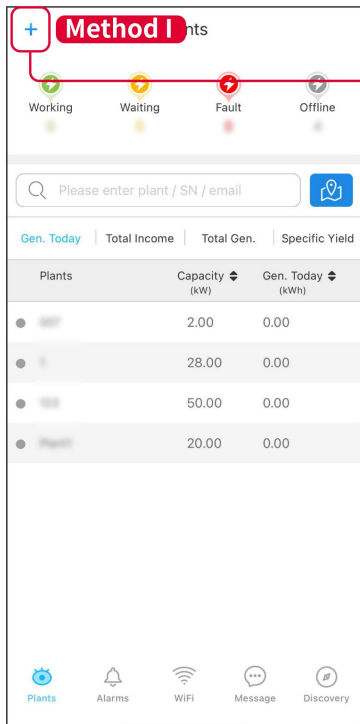

SEMS00CON0009

9 System Commissioning

9.1 Introduction to SolarGo

SolarGo App is a mobile application that communicates with the inverter through bluetooth or WiFi modules. Commonly used functions are as follows:

1. Check the operating data, software version, alarms, etc.
2. Set grid parameters, communication parameters, safety countries, power limitation, etc.
3. Equipment maintenance.
4. Upgrade the firmware version of the equipment.

9.1.1 Menu Structure of the App

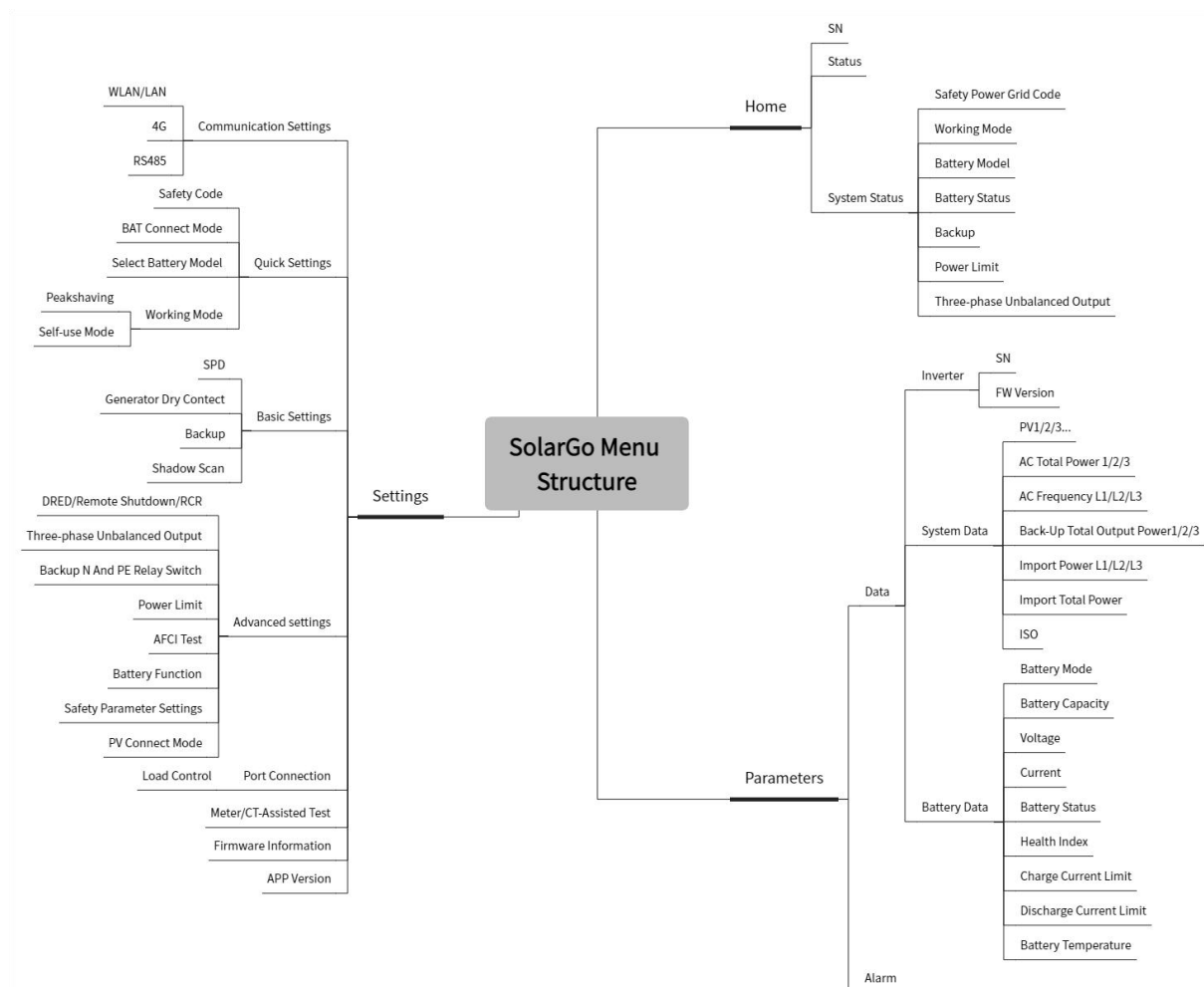

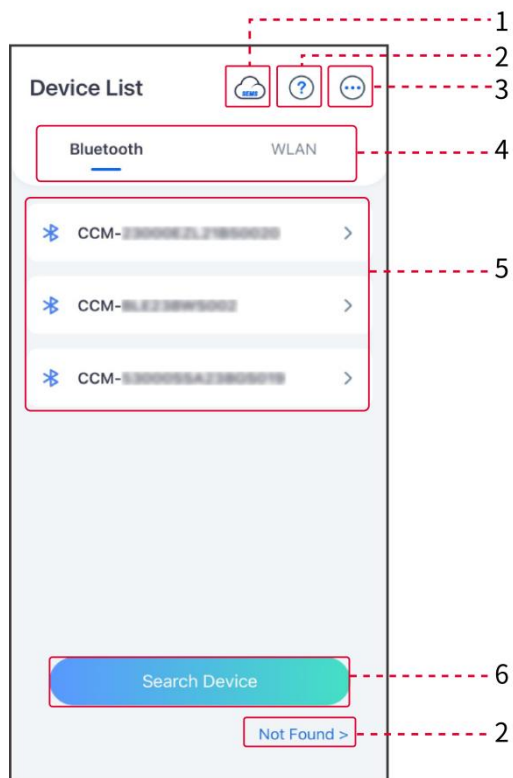

SLG00DSC0001

9.1.2 Login Page of SolarGo App



SLG00CON0008



No.	Name/Icon	Description
1		Tap the icon to open the page downloading the SEMS Portal app.
2		Tap to read the connection guide.
	Not found	
3		<ul style="list-style-type: none"> ● Check information such as app version, local contacts, etc. ● Other settings, such as update date, switch language, set temperature unit, etc.
4	Bluetooth/WLAN	Select based on actual communication method. If you have any problems, tap or NOT Found to read the connection guides.
5	Device List	<ul style="list-style-type: none"> ● The list of all devices. The last digits of the device name are normally the serial number of the device. ● Select the device by checking the serial number of the master inverter when multi inverters are parallel connected. ● The device name varies depending on the inverter model or communication module.

6	Search Device	Tap Search Device if the device is not found.
---	---------------	---

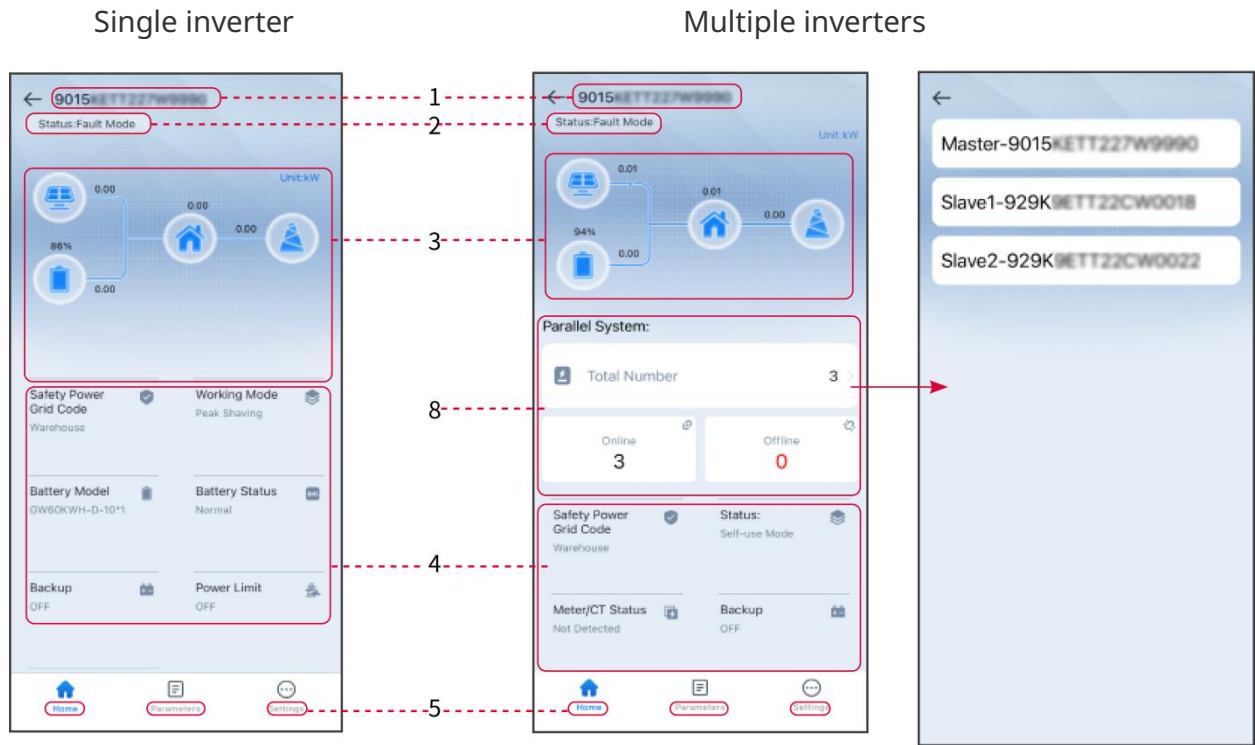
9.1.3 Home Page of SolarGo App



SLG00CON0009

No.	Name/Icon	Description
1	Serial Number	Serial number of the connected inverter or serial number of the master inverter in the parallel system.
2	Device Status	Indicates the status of the inverter, such as Working, Fault, etc.
3	Energy Flow Chart	Indicates the energy flow chart of the PV system. The actual page prevails.
4	System Status	Indicates the system status, such as Safety Code, Working Mode, Battery Model, Battery Status, Power Limit, Three-Phase Unbalanced Output, etc.
5	 Home	Home. Tap Home to check Serial Number, Device Status, Energy Flow Chart, System Status, etc.
6	 Parameters	Parameters. Tap Parameters to check the running parameters of the system.

	Parameters	
7	 Settings	<ul style="list-style-type: none"> ● Settings. ● Log in before entering Quick Settings and Advanced Settings. Initial password: goodwe2010 or 1111.
8	Parallel	Tap Total Number to check serial number of all inverters. Tap the serial number to enter the setting page of the single inverter.

9.2 Connecting the Inverter to SolarGo App

NOTICE

The device name varies depending on the inverter model or communication module:

- Wi-Fi Kit: Solar-WiFi***
 - Bluetooth module: Solar-BLE***
 - WiFi/LAN Kit-20: WLA-***
 - Ezlink3000: CCM-BLE***; CCM-***; ***
 - 4G Kit-CN-G20 or 4G Kit-CN-G21: GSA-*** or GSB-***
- *** is the inverter serial number*

Connecting the inverter via Bluetooth

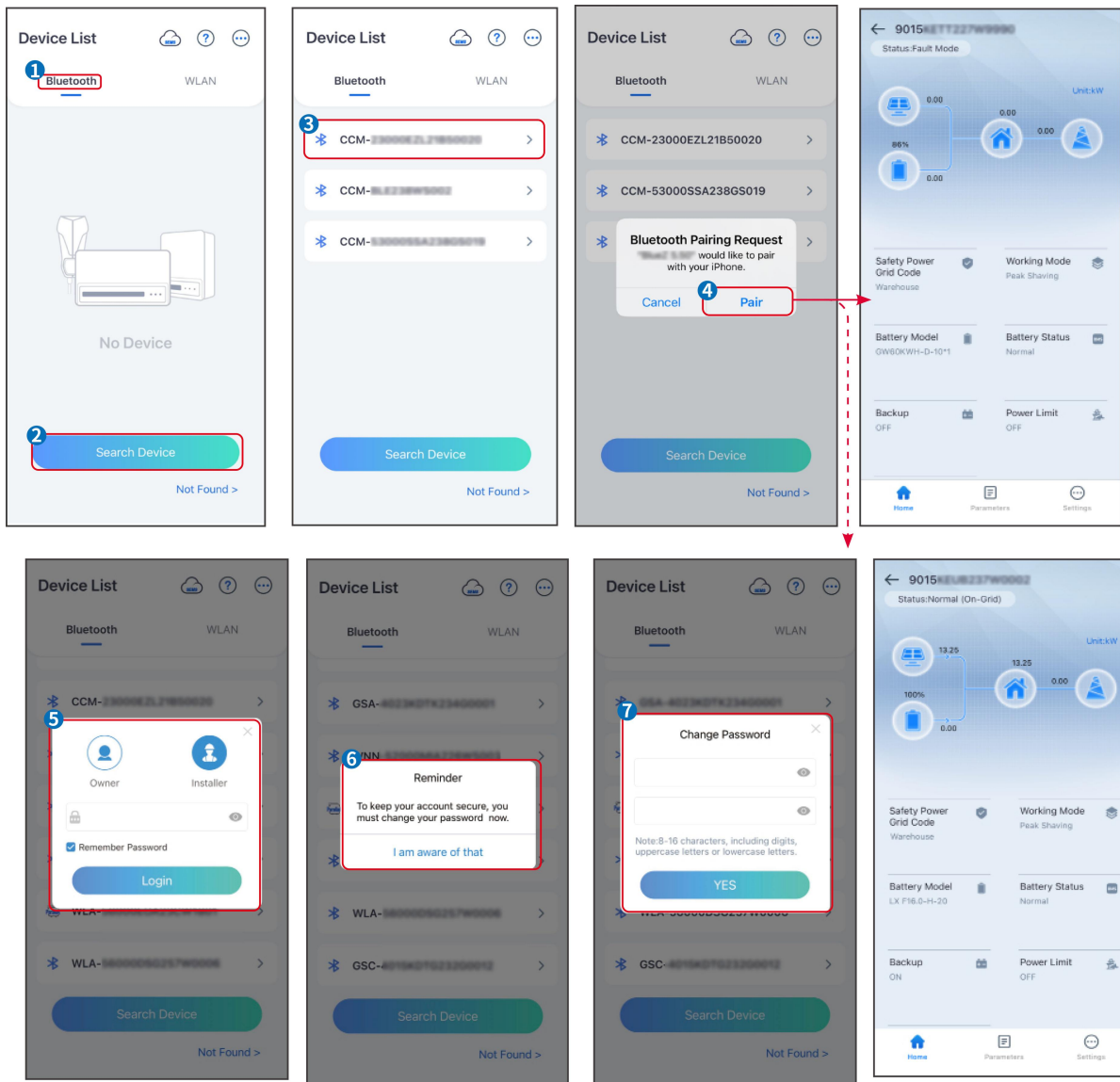

SLG00CON001

Connecting the inverter via WiFi

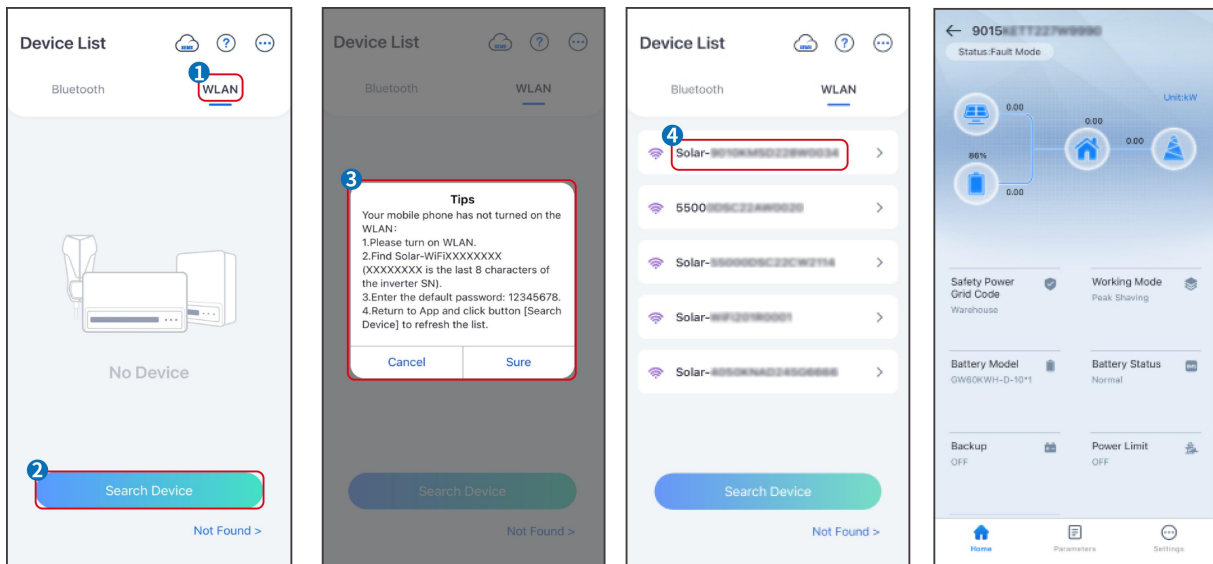

SLG00CON002

9.3 Communication Settings

NOTICE

The communication configuration interface may vary depending on the type of smart dongle connected to the inverter. Please refer to the actual interface for accurate information.

Setting Privacy and Security

Type I

Step 1 Tap **Home > Settings > Communication Setting > Privacy & Security** to set the parameters.

Step 2 Set the new password for the WiFi hotspot of the communication module, and tap **Save**.

Step 3 Open the WiFi settings of your phone and connect to the inverter's WiFi signal (SolarWiFi***) with the new password.

Type II

Step 1 Tap **Home > Settings > Communication Setting > Privacy & Security** to set the parameters.

Step 2 Enable **Bluetooth Stays On** or **WLAN Control** based on actual needs.

Setting WLAN/LAN Parameters

Step 1 Tap **Home > Settings > Communication Setting > Network Settings** to set the parameters.

Step 2 Set the WLAN or LAN parameters based on actual situation.

No.	Name/Icon	Description
1	Network Name	Only for WLAN. Select WiFi based on the actual connecting.
2	Password	Only for WLAN. WiFi password for the actual connected network.
3	DHCP	<ul style="list-style-type: none"> ● Enable DHCP if the router is in Dynamic IP mode. ● Disable DHCP when a switch is used or the router is in static IP mode.
4	IP address	<ul style="list-style-type: none"> ● Do not configure the parameters when DHCP is enabled. ● Configure the parameters according to the router or switch information when DHCP is disabled.
5	Subnet Mask	
6	Gateway Address	
7	DNS Server	

9.4 Quick Settings

NOTICE

- The parameters will be configured automatically after selecting the safety country/region, including overvoltage protection, undervoltage protection, overfrequency protection, underfrequency protection, voltage/frequency connection protection, $\cos\phi$ curve, Q(U) curve, P(U) curve, FP curve, HVRT, LVRT, etc.
- The power generation efficiency varies in different working modes. Set the working mode according to the local requirements and situation.

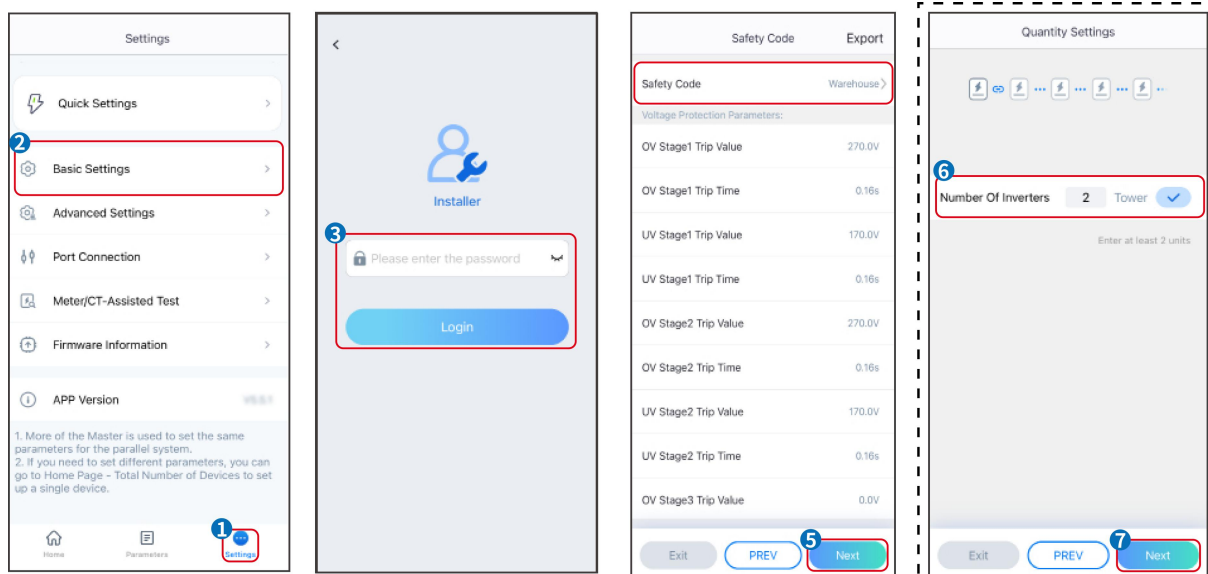

SLG00CON003

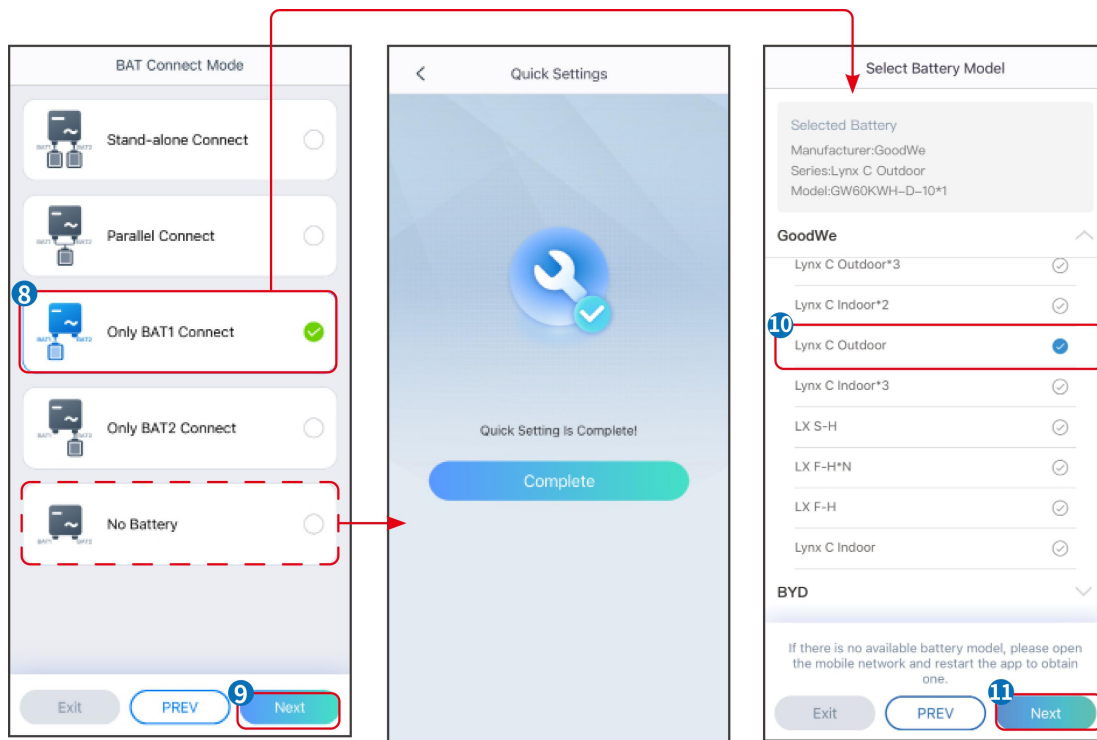

SLG00CON0004

Parameters	Description
Safety Code	Select safety country accordingly.
BAT Connect Mode	Select the actual mode in which the battery is connected to the inverter. No need to set the battery model and working mode if there is no battery is connected. The system will work in self-use mode by default.
Select Battery Model	Select the actual battery model.
Working Mode	Set the working mode based on actual needs. Supports: Peakshaving mode and Self-use mode.

The app interface is as following when Self-use mode is selected. Enter Advanced Settings to set the detailed working mode and related parameters.

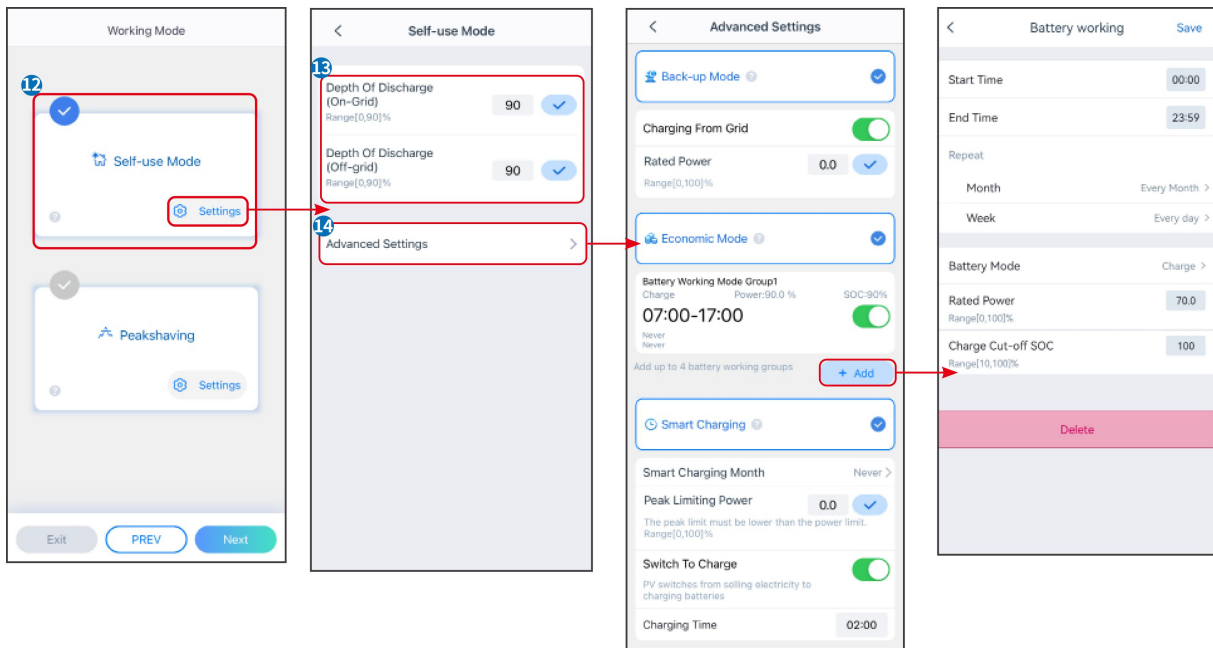

SLG00CON0005

Parameters	Description
Self-use mode: based on the self-use mode, Back-up mode, Economic mode, and Smart charging can be enabled at the same time, and the inverter will automatically select the working mode. Working priority: Back-up mode> Economic mode >Smart charging	
Depth Of Discharge (On-Grid)	The maximum depth of discharge of the battery when the system is working on-grid.
Depth Of Discharge (Off-grid)	The maximum depth of discharge of the battery when the system is working off-grid.
Back-up mode	
Charging From Grid	Enable Charging From Grid to allow power purchasing from the utility grid.
Rated Power	The percentage of the purchasing power to the rated power of the inverter.
Economic mode	
Start Time	Within the Start Time and End Time, the battery is charged or discharged according to the set Battery Mode as well as the Rated Power.
End Time	
Battery Mode	Set to charge or discharge as required.
Rated Power	The percentage of the charging/discharging power to the rated power of the inverter.
Charge Cut-off SOC	The battery stop charging/discharging once the battery SOC reaches Charge Cut-off SOC.
Smart charging	

Smart Charging Month	Set the smart charging months. More than one month can be set.
Peak Limiting Power	Set the Peak Limiting Power in compliance with local laws and regulations. The Peak Limiting Power shall be lower than the output power limit specified by local requirements.
Switch to Charge	During charging time, the PV power will charge the battery.

The app interface is as following when Peakshaving mode is selected.

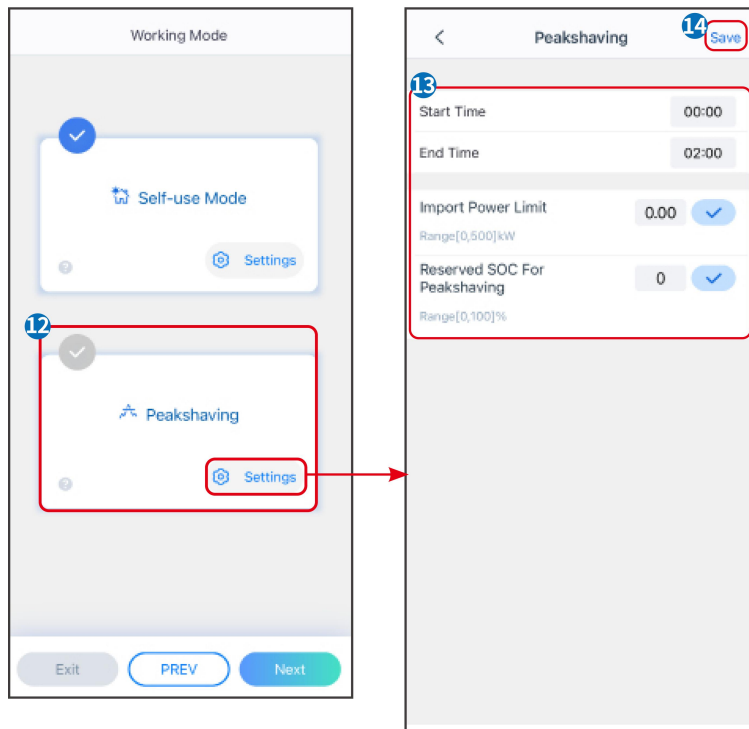

SLG00CON0006

Parameters	Description
Peakshaving	
Start Time	The utility grid will charge the battery between Start Time and End Time if the load power consumption do not exceed the power quota. Otherwise, only PV power can be used to charge the battery.
End Time	
Import Power Limit	Set the maximum power limit allowed purchasing from the grid. When the loads consume power exceed the sum of the power generated in the PV system and Import Power Limit, the excess power will be made up by the battery.
Reserved SOC For Peakshaving	In Peak Shaving mode, the battery SOC should be lower than Reserved SOC For Peakshaving. Once the battery SOC is higher than Reserved SOC For Peakshaving, the peak shaving mode fails.

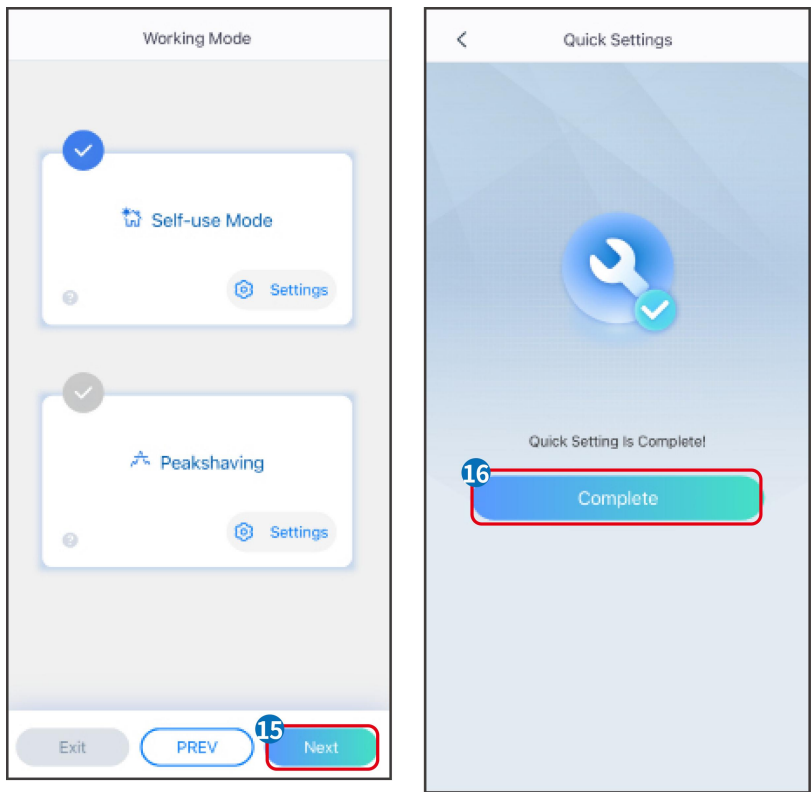

SLG00CON0007

9.5 Setting the Basic Function

9.5.1 Setting the Basic Parameters

Step 1: Tap **Home**> **Settings** > **Basic Settings**, to set the parameters.

Step 2: Set the functions based on actual needs.

Shadow Scan and SPD

No.	Parameters	Description
1	Shadow Scan	Enable Shadow Scan when the PV panels are severely shadowed to optimize the power generation efficiency.
2	SPD	After enabling SPD, when the SPD module is abnormal, there will be SPD module abnormal alarm prompt.

Setting the Backup Function

After enabling Backup, the battery will power the load connected to the backup port of

the inverter to ensure Uninterrupted Power Supply when the power grid fails.

No.	Parameters	Description
1	UPS Mode - Full Wave Detection	Check whether the utility grid voltage is too high or too low.
2	UPS Mode - Half Wave Detection	Check whether the utility grid voltage is too low.
3	EPS Mode - Supports LVRT	Stop detecting utility grid voltage.
4	First Cold Start (Off-grid)	Take effect once. In off-grid mode, enable First Cold Start (Off-grid) to output backup supply with battery or PV.
5	Cold Start Holding	Take effect multiple times. In off-grid mode, enable First Cold Start (Off-grid) to output backup supply with battery or PV.
6	Clear Overload History	Once the power of loads connected to the inverter BACK-UP ports exceeds the rated load power, the inverter will restart and detect the power again. The inverter will perform restart and detection several times until the overloading problem is solved. Tap Clear Overload History to reset the restart time interval after the power of the loads connected to the BACK-UP ports meets the requirements. The inverter will restart immediately.

9.5.2 Setting Advanced Parameters

Step 1: Tap **Home > Settings > Advanced Settings** to set the parameters.

Step 2: Set the parameters based on actual needs. Tap '✓' or Save to save the settings. The parameters are set successfully.

AFCI (Optional)

Reasons to occur electric arcs:

- Damaged connectors in the PV or battery system.
- Wrong connected or broken cables.
- Aging connectors and cables.

Methods to detect electric arcs:

- The inverter has an integrated AFCI function satisfies IEC63027.

- When the inverter detects an electric arc, users can find the time of the fault and the detailed phenomenon through the app.
- The inverter will shutdown for protection until the AFCI alarms are cleared. After clearing the alarms, the inverter can automatically reconnect to the grid.
 - Automatic reconnection: The alarm can be cleared automatically in 5 minutes if the inverter triggers a fault for less than 5 times within 24 hours.
 - Manual reconnection: The inverter will shutdown for protection after the 5th electric arc fault within 24 hours. The inverter cannot work normally until the fault is solved.

AFCI is disabled by default, enable it through SolarGo app if needed.

Model	Label	Description
GW15K-ET	F-I-AFPE-1-2/2-2	F: Full coverage I: Integrated AFPE: Detection and interruption capability provided 1: 1 monitored string per input port 2/2: 2/2 input ports per channel 2: 2 monitored channels
GW20K-ET		
GW20K-ET	F-I-AFPE-1-2/4-2	F: Full coverage I: Integrated AFPE: Detection and interruption capability provided 1: 1 monitored string per input port 2/4: 2/4 input ports per channel 2: 2 monitored channels
GW29.9K-ET		
GW30K-ET		

No.	Parameters	Description	
1	AFCI Test	AFCI Test	Enable or disable AFCI accordingly.
		AFCI Test Status	The test status, like Not Self-checking, self-check succeeded, etc.
		Clear AFCI Alarm	Clear ARC Faulty alarm records.
		Self-check	Tap to check whether the AFCI function works normally.
2	PV Access Mode	Stand-alone Connect	The PV strings are connected to the MPPT terminals one by one.
		Partial Parallel Connect	The PV strings are connected to the inverter in both standalone and parallel connection. For example, one PV string connect to MPPT1 ad MPPT2, another PV string connect to MPPT3.

		Parallel Connect	The external PV string is connected to multi MPPT terminals of the inverter.
--	--	------------------	--

9.5.3 Setting Power Limit Parameters

Step 1 Tap **Home > Settings > Advanced Settings > Power Limit** to set the parameters.

Step 2 Enable or disable the power limit function based on actual needs.

Step 3 Enter the parameters and tap \checkmark . The parameters are set successfully.

No.	Parameters	Description
Power Limit Setting For Countries/Regions except Australia		
1	Power Limit	Enable Power Limit when power limiting is required by local grid standards and requirements.
2	Export Power (W)	Set the value based on the actual maximum power feed into the utility grid.
3	External CT Ratio	Set the ratio of the primary current to the secondary current of the external CT.
Power Limit Setting For Australia		
1	Soft Limit	Enable Soft Limit when power limiting is required by local grid standards and requirements.
2	Export Power	Set the value based on the actual maximum power feed into the utility grid.
3	Hard Limit	After enabling this function, the inverter and the utility grid will automatically disconnect when the power feeds into the grid exceeds the required limit.

9.5.4 Setting the Battery Parameters

Step 1 Tap **Home > Settings > Advanced Settings > Battery Function** to set the parameters.

Step 2 Enter the parameters and tap \checkmark . The parameters are set successfully.

No.	Parameters	Description
1	Max. Charging Current	Set the maximum charging current based on actual needs.

2	Max. Discharging Current	Set the maximum discharging current based on actual needs.
3	SOC Protection	Start battery protection when the battery capacity is lower than the Depth of Discharge.
4	Depth Of Discharge (On-Grid)	Indicates the depth of discharge of the battery when the inverter is on-grid or off-grid.
5	Depth Of Discharge (Off-grid)	
6	Backup SOC Holding	The battery will be charged to preset SOC protection value by utility grid or PV when the system is running on-grid. So that the battery SOC is sufficient to maintain normal working when the system is off-grid.
7	Immediate Charging	Enable to charge the battery by the grid immediately. Take effect once. Enable or Disable based on actual needs.
8	SOC For Stopping Charging	Stop charging the battery once the battery SOC reaches SOC For Stopping Charging.
9	Immediate Charging Power	Indicates the percentage of the charging power to the inverter rated power when enabling Immediate Charging. For example, setting the Immediate Charging Power of a 10kW inverter to 60 means the charging power of the inverter is $10\text{kW} \times 60\% = 6\text{kW}$.

9.5.5 Setting Load Control

Step 1 Tap **Home** > **Settings** > **Load Control** to set the parameters.

Step 2 Enter the parameters and tap \checkmark . The parameters are set successfully.

Dry Contact Mode: when the switch is ON, the loads will be powered; when the switch is OFF, the power will be cut off. Turn the switch on or off based on actual needs.

Time Mode: set the time to enable the load, and the load will be powered automatically within the setting time period. Select standard mode or intelligent mode.

No.	Parameters	Description
-----	------------	-------------

1	Standard	The loads will be powered within the setting time period.
2	Intelligent	Once the excess energy of the photovoltaic exceeds the load nominal power within the time period, the loads will be powered.
3	Start Time	The time mode will be on between the Start Time and End Time.
4	End Time	
5	Repeat	The repeat days.
6	Load Consumption Time	The shortest load working time after the loads been powered. The time is set to prevent the loads be turned on and off frequently when the PV power fluctuates greatly. Only for Intelligent mode.
7	Load Rated Power	The loads will be powered when the excess energy of the photovoltaic exceeds the nominal power of load. Only for Intelligent mode.

SOC mode: the inverter has an integrated relay controlling port, which can control the loads off or on. In off-grid mode, the load connected to the port will not be powered if the BACKUP overload is detected or the battery SOC value is lower than the Off-grid battery protection value.

9.6 Setting Safety Parameters

9.6.1 Setting Basic Safety Parameters

NOTICE

The grid standards of some countries/regions require that inverters shall set functions to meet local requirements.

Step 1 Tap **Home > Settings > Advanced Settings** to set the parameters.

No.	Parameters	Description
1	DRED/Remote Shutdown/RCR/EnWG 14a	Enable DRED/Remote Shutdown/RCR/EnWG 14a before connecting the third party DRED, remote shutdown, or RCR, EnWG 14a device to comply with local laws and regulations.
2	Three-phase Unbalanced Output	Enable Three-phase Unbalanced Output when the utility grid company adopts phase separate billing.

3	Backup N and PE Relay Switch	To comply with local laws and regulations, ensure that the relay inside the back-up port remains closed and the N and PE wires are connected when the inverter is working off-grid.
4	AutoTest	Enable AUTO TEST to set auto test for grid tying in compliance with local grid standards and requirements.

9.6.2 Setting Customized Safety Parameters

NOTICE

Set the custom safety parameters in compliance with local requirements. Do not change the parameters without the prior consent of the grid company.

9.6.2.1 Setting the Active Power Mode

Setting the P(F) Curve

Step 1 Tap **Home > Settings > Advanced Settings > Safety Parameters > Active Power Mode** to set the parameters.

Step 2 Set the parameters based on actual needs.

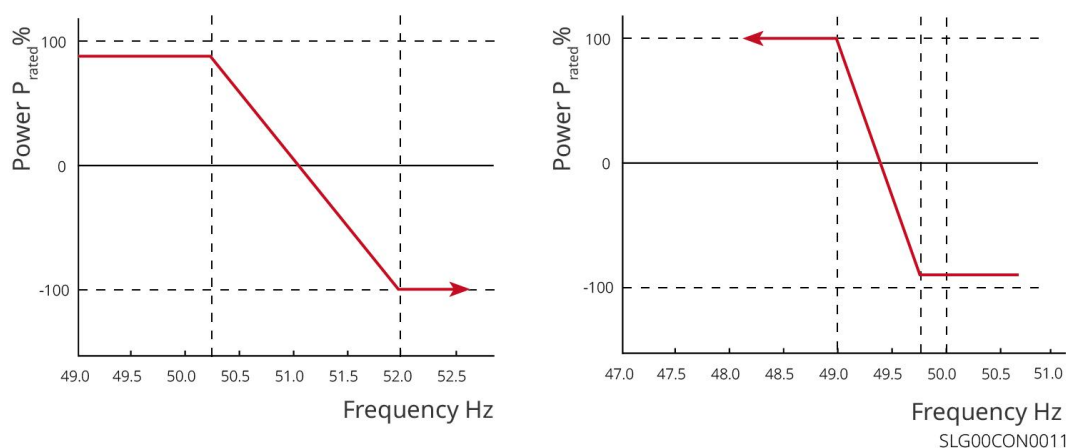

Setting the P(U) Curve

Step 1 Tap **Home > Settings > Advanced Settings > Safety Parameters > Active Power Mode** to set the parameters.

Step 2 Enter the parameters. The inverter will adjust the active output power to the apparent power ratio in real-time according to the actual grid voltage to the rated voltage ratio.

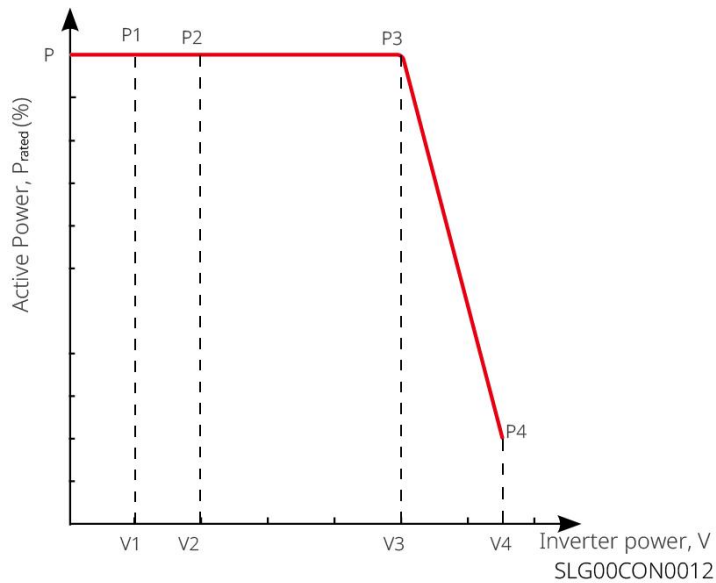

9.6.2.2 Setting the Reactive Power Mode

Setting the Fix PF

Step 1 Tap **Home > Settings > Advanced Settings > Safety Parameter Settings > Reactive Power Mode** to set the parameters.

Step 2 Set the parameter based on actual needs. The power factor remains fixed during the inverter working process.

No.	Parameters	Description
1	Fix PF	Enable Fix PF when it is required by local grid standards and requirements.
2	Under-excited	Set the power factor as lagging or leading based on actual needs and local grid standards and requirements.
3	Over-excited	
4	Power Factor	Set the power factor based on actual needs. Range: 0~-0.8, or +0.8~+1.

Setting the Fix Q

Step 1 Tap **Home > Settings > Advanced Settings > Safety Parameter Settings > Reactive Power Mode** to set the parameters.

Step 2 Set the parameter based on actual needs. The output reactive power remains fixed during the inverter working process.

No.	Parameters	Description
-----	------------	-------------

1	Fix Q	Enable Fix Q when it is required by local grid standards and requirements.
2	Under-excited	Set the reactive power as inductive or capacitive reactive power based on actual needs and local grid standards and requirements.
3	Over-excited	
4	Power Factor	The percentage of reactive output power to apparent power.

Setting the Q(U) Curve

Step 1 Tap Home > Settings > Advanced Settings > Safety Parameter Settings > Reactive Power Mode to set the parameters.

Step 2 Enter the parameters. The inverter will adjust the reactive power to the apparent power ratio in real-time according to the actual grid voltage to the rated voltage ratio.

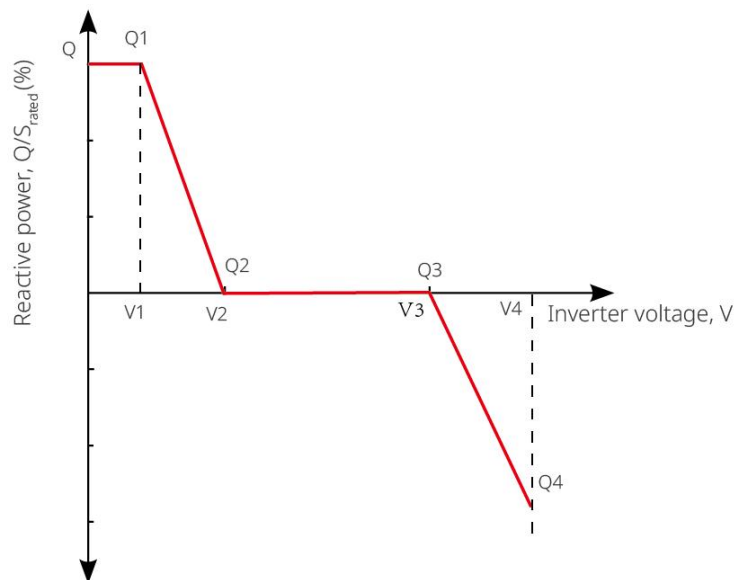

SLG00CON0013

Setting the Cosφ Curve

Step 1 Tap Home > Settings > Advanced Settings > Safety Parameter Settings > Reactive Power Mode to set the parameters.

Step 2 Enter the parameters. The inverter will adjust the active output power to the apparent power ratio in real-time according to the actual grid voltage to the rated voltage ratio.

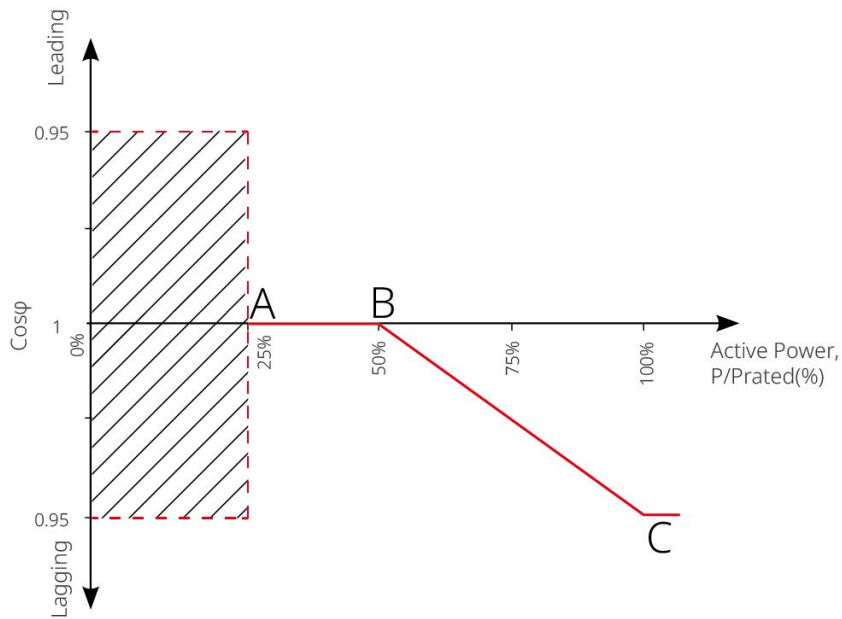

SLG00CON0014

9.6.2.3 Setting Protection Parameters

Step 1 Tap Home > Settings > Advanced Settings > Safety Parameter Settings> Protection Parameters to set the parameters.

Step 2 Set the parameters based on actual needs.

No.	Parameters	Description
Voltage Protection Parameters		
1	OV Stage n Trip Value	Set the grid overvoltage protection threshold value, n = 1, 2, 3.
2	OV Stage n Trip Time	Set the grid overvoltage protection tripping time, n = 1, 2, 3.
3	UV Stage n Trip Value	Set the grid undervoltage protection threshold value, n= 1, 2, 3.
4	UV Stage n Trip Time	Set the grid undervoltage protection tripping time, n = 1, 2, 3.
5	Grid 10min Overvoltage	Set the 10min overvoltage protection threshold value.
Frequency Protection Parameters		
6	OF Stage n Trip Value	Set the grid overfrequency protection threshold value, n = 1, 2.
7	OF Stage n Trip Time	Set the grid overfrequency protection tripping time, n = 1, 2.
8	UF Stage n Trip Value	Set the grid underfrequency protection threshold value, n = 1,

		2.
9	UF Stage n Trip Time	Set the grid underfrequency protection tripping time, n = 1, 2.

9.6.2.4 Setting Connection Parameters

Step 1 Tap **Home** > **Settings** > **Advanced Settings** > **Safety Parameter Settings** > **Connection Parameters** to set the parameters.

Step 2 Set the parameters based on actual needs.

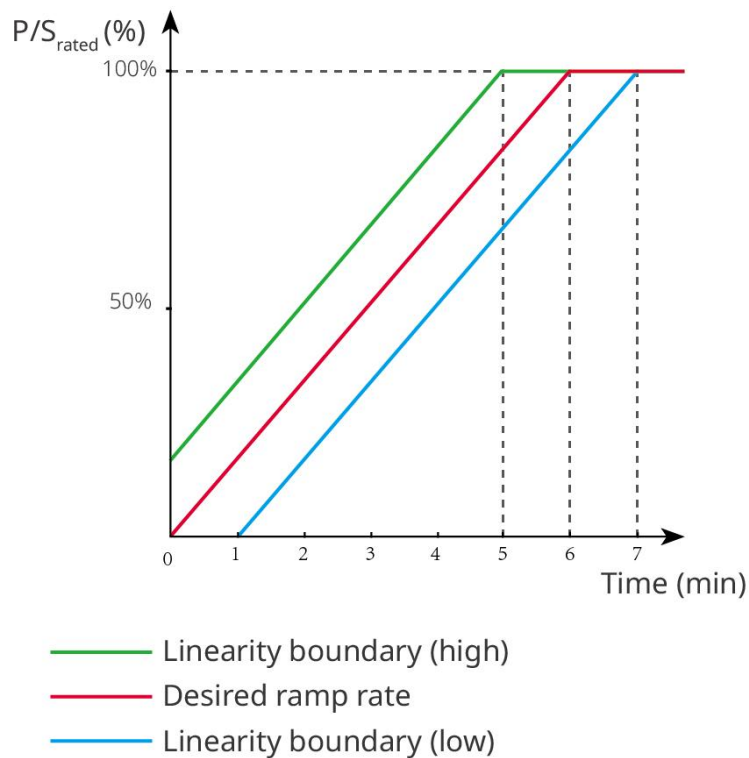

SLG00CON0015

9.6.2.5 Setting Voltage Ride Through Parameters

Step 1 Tap **Home** > **Settings** > **Advanced Settings** > **Safety Parameter Settings** > **Voltage Ride Through** to set the parameters.

Step 2 Set the parameters based on actual needs.

No.	Parameters	Description
LVRT		
1	Ride Through Voltage Start Point	The inverter will not be disconnected from the utility grid immediately when the grid voltage is between Ride Through Voltage Start Point and Ride Through Voltage End Point.
2	Ride Through Voltage End Point	
3	Ride Through Time Start Point	Indicates the longest duration the inverter can remain connected to the grid when the grid voltage is at the Ride Through Voltage Start Point.
4	Ride Through Time End Point	Indicates the longest duration the inverter can remain connected to the grid when the grid voltage is at the Ride Through Voltage End Point.
5	Ride Through Trip Threshold	LVRT is allowed when the grid voltage is lower than Ride Through Trip Threshold
HVRT		
6	Ride Through Voltage Start Point	The inverter will not be disconnected from the utility grid immediately when the grid voltage is between Ride Through Voltage Start Point and Ride Through Voltage End Point.
7	Ride Through Voltage End Point	
8	Ride Through Time Start Point	Indicates the longest duration the inverter can remain connected to the grid when the grid voltage is at the Ride Through Voltage Start Point.
9	Ride Through Time End Point	Indicates the longest duration the inverter can remain connected to the grid when the grid voltage is at the Ride Through Voltage End Point.
10	Ride Through Trip Threshold	HVRT is allowed when the grid voltage is higher than Ride Through Trip Threshold

10 Monitoring Power Plant

10.1 SEMS Portal Overview

SEMS Portal App is a monitoring platform. Commonly used functions are as follows:

1. Manage the organization or User information;
2. Add and monitor the power plant information;
3. Equipment maintenance.

Login Page of SEMS Portal App

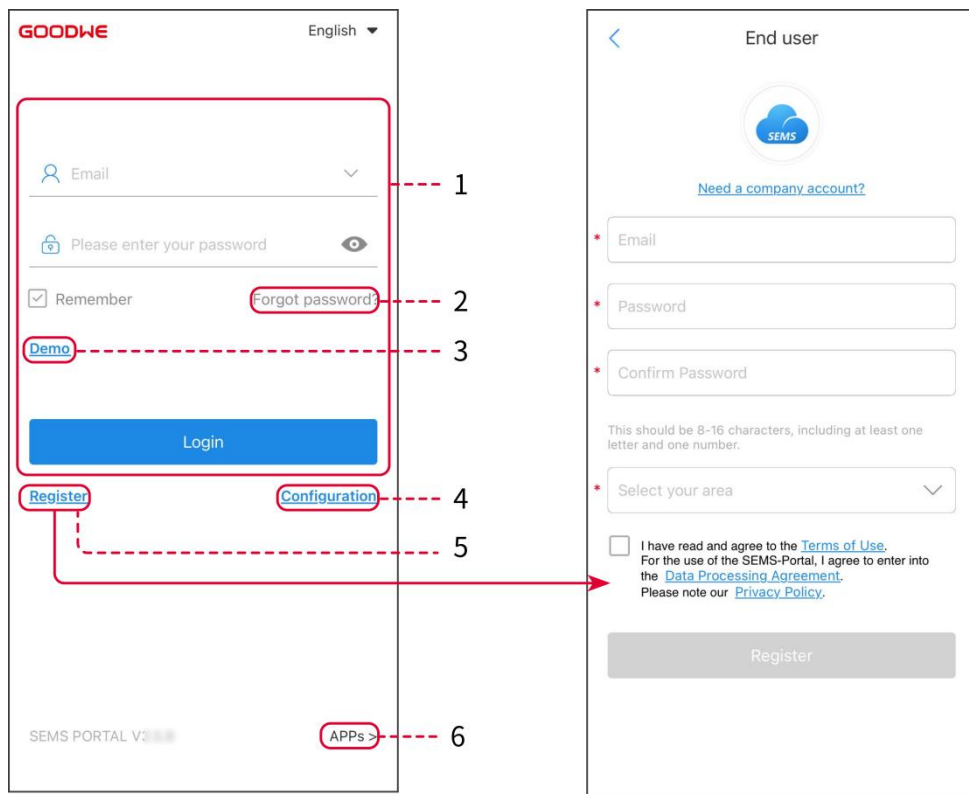

SEMS00CON0002



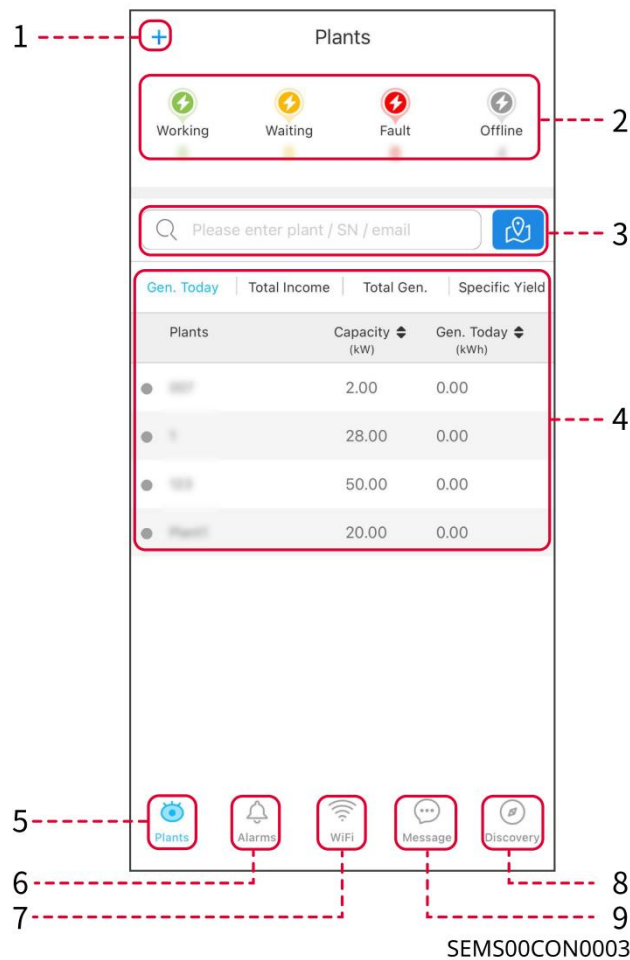

No.	Name	Description
1	Login Area	Enter the user name, password to login to the app.
2	Forget Password	Tap to reset the password by verifying the account.
3	Demo	Tap to enter the sample plant page. The sample page only displays contents with Visitor account, which is for reference only.
4	Configuration	Configure WiFi parameters to establish communication between the inverter and the server and realize remote monitoring and managing.

5	Register	Tap to register an end-user account. Contact the manufacturer or the company as prompted if you need a company account.
6	Demo	Tap to enter the sample plant page. The sample page only displays contents with Visitor account, which is for reference only.

Home Page of SEMS Portal App



No.	Name	Description
1		Create a new power plant.
2	Plant status	The summary of the plants working information under the account.
3	Find the plant	Find the plant by entering the plant name, device SN, Email address, or map.
4	Generation	The working information of a single plant. Tap the plant name to check the detailed information of the plant, such as plant name,

	statistics	location, power, capacity, generation today, total generation, etc.
5	 Plants	Plant monitoring page.
6	 Alarms	Check all alarms, happening alarms, and recovered alarms.
7	 WiFi	Complete WiFi configurations when a Wi-Fi Kit dongle is used.
8	 Message	Message Set and check system messages.
9	 Discovery	Discovery to Edit the account, create My QR Code, set Income Settings , etc.

10.2 Managing the Plant or Devices

10.2.1 Creating Power Plants

Step 1 Enter the **Create Plant** page.

Step 2 Read the instructions and fill in the requested plant information based on actual situation. (* refers to the mandatory items)

Step 3 Follow the prompts to add devices and create the plant.

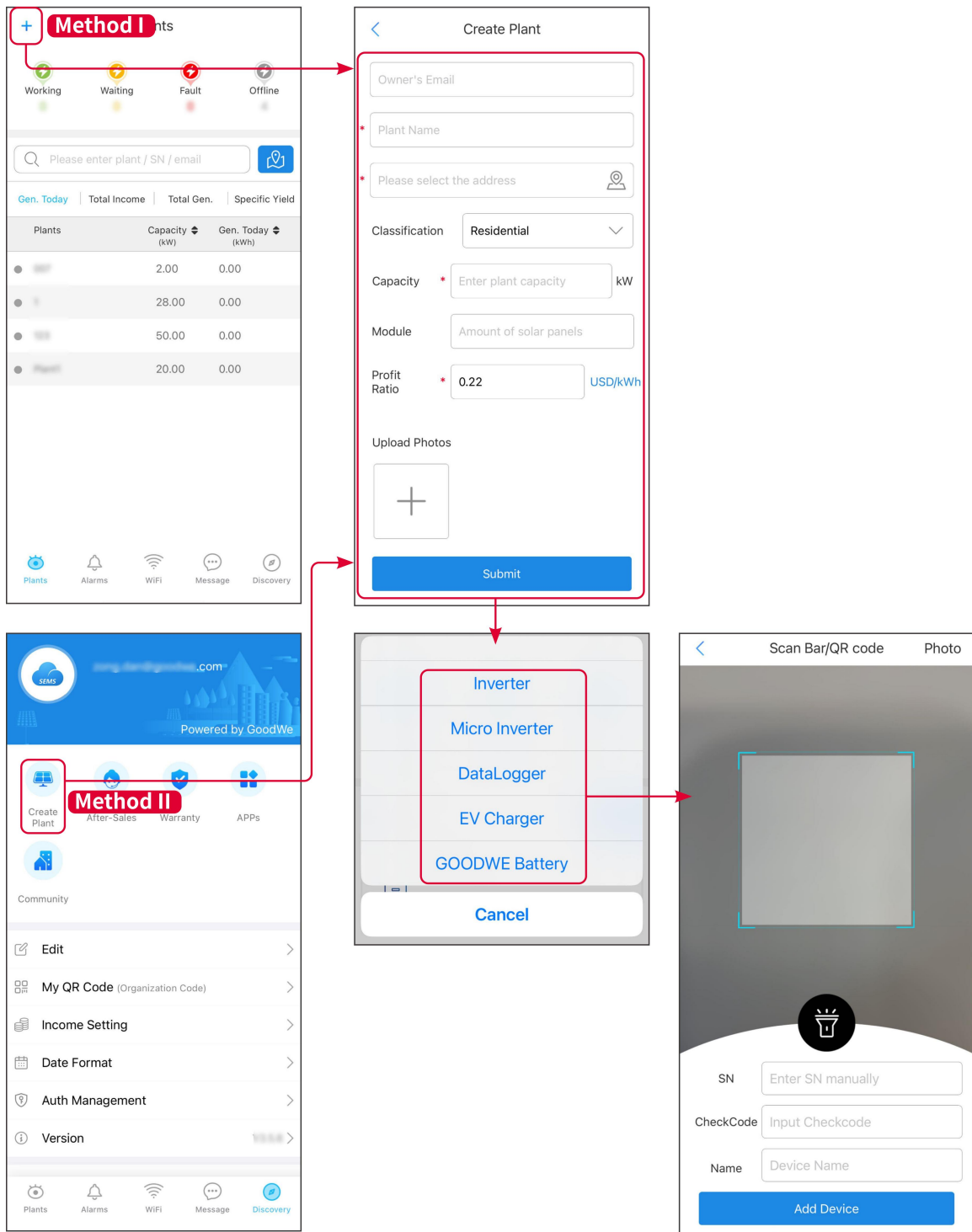

SEMS00CON0009

10.2.2 Managing the Plant

Step 1 Enter the power plant monitoring page and delete or modify the power plant information based on actual needs.

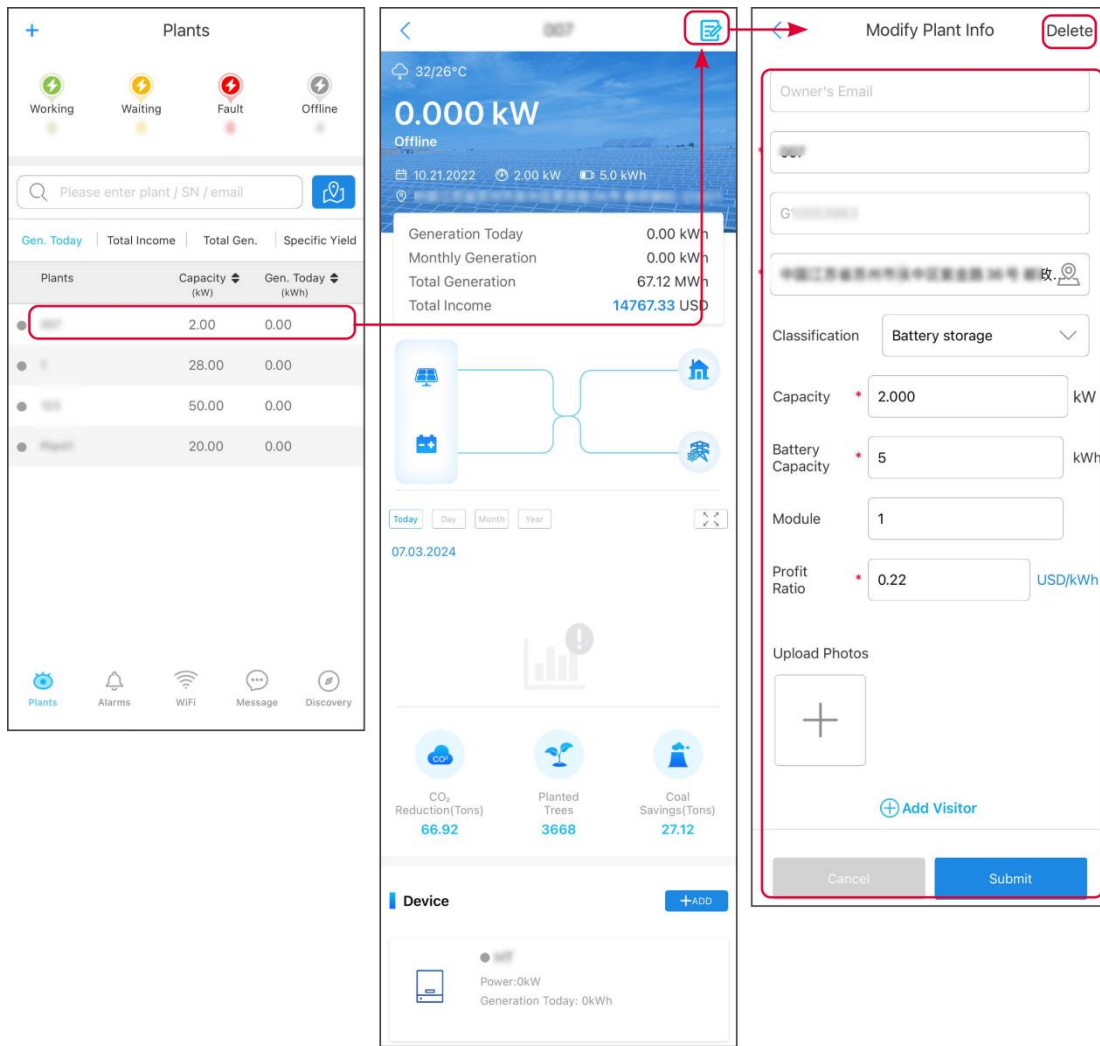

SEMS00CON0010

10.2.3 Managing the Devices

Step 1 Select the power plant and enter the detailed information page.

Step 2 Add, delete, or replace the devices based on actual needs.

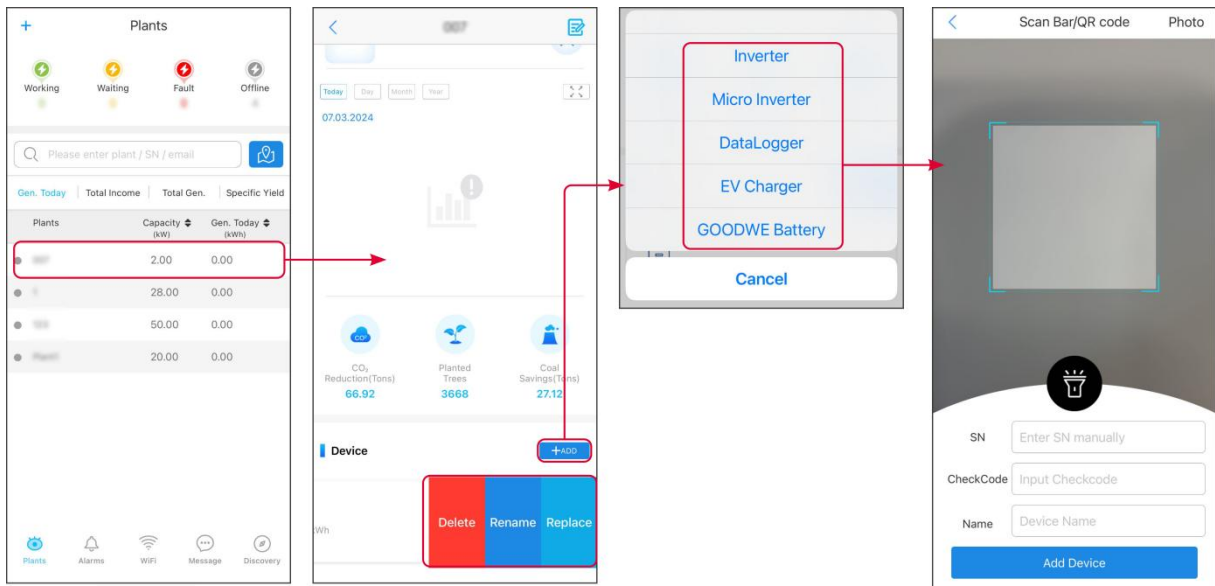

SEMS00CON0011

10.3 Monitoring the Plant

10.3.1 Checking the Plant Information

Log in the SEMS Portal app with the account and password. The overall working situation of all power plants under this account will be displayed.

The interface varies depending on the devices.

Step 1 (optional) Search the plant name, inverter SN, or Email to find out the plant quickly. Or tap the map icon to search the plant.

Step 2 Tap the plant name in the plant list or the plant icon in the map to check detailed information about the plant.

Step 3 Check the plant information, power generation situation, device information, faults, etc.

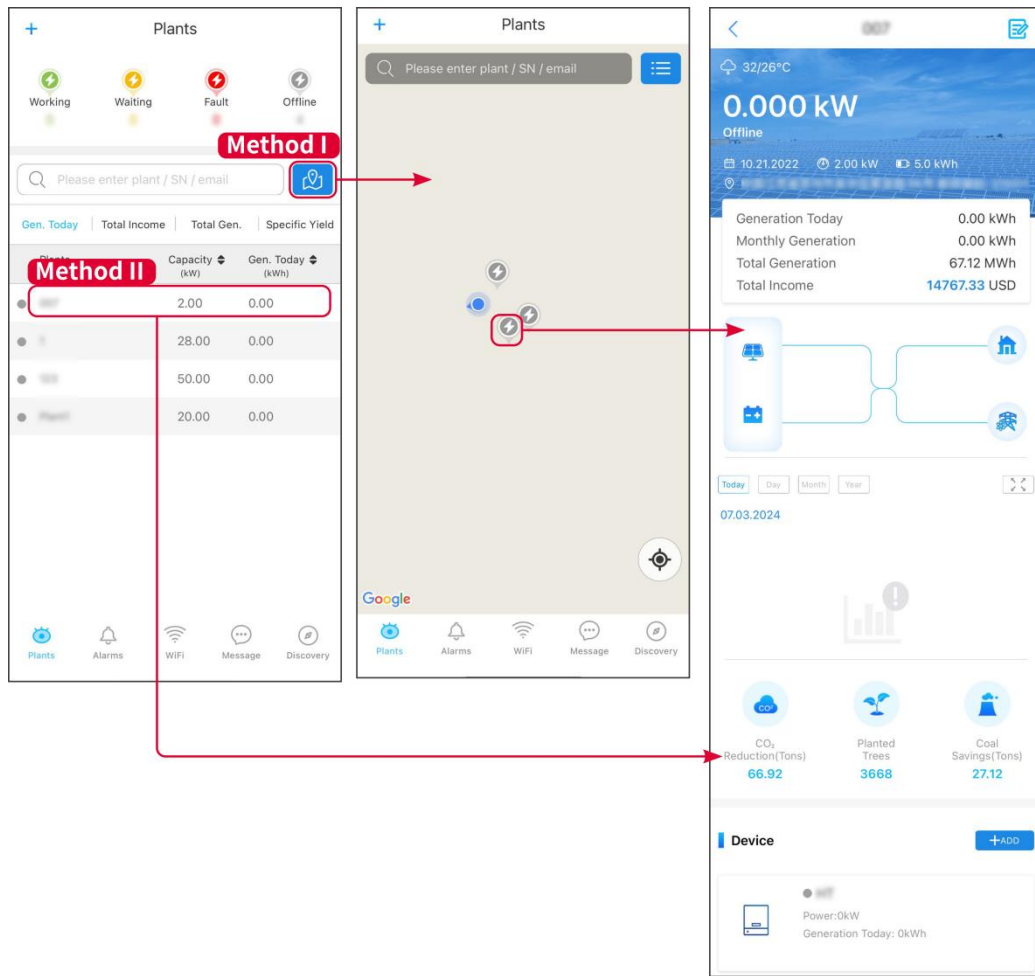

SEMS00CON0012

10.3.2 Viewing Alarm Information

Step 1 Tap Alarm tab and enter the Alarm Details page.

Step 2 (optional) Enter the plant name, inverter SN, or owner's Email address in the search bar

to find out the plant which is alarming.

Step 3 Tap the alarm name to check the alarm details.

Alarms

1 All
4388171

1 Happening
8176

1 Recovered
4388166

Plant	Alarm	Occurrence
WAARE SOLAR	Utility Loss	07.03.2024 07:23
WAARE SOLAR	Vac Fail	07.03.2024 07:23
Wp Powerline	Vac Fail	07.03.2024 04:22
Wp Powerline	Vac Fail	07.03.2024 07:52
	Fac Fail	07.03.2024 10:22
	Vac Fail	07.03.2024 10:22
	Utility Loss	07.03.2024 10:22
gpowerline	Vac Fail	07.03.2024 07:52
gpowerline	Utility Loss	07.03.2024 07:52
gpowerline	Fac Fail	07.03.2024 07:52
Thermax	Vac Fail	07.03.2024 07:52

Plants

Alarms

WiFi

Message

Discovery

Alarm Details

WAARE SOLAR
☆

Owner: --

Device: INVERTER

SN: [REDACTED]

Alarm: Utility Loss

Status: Happening

Occurrence: 07.03.2024 07:23:01

Recovery: --

Possible Reasons

1. Grid power fails.
2. AC connection is not good.
3. AC breaker fails
4. Grid is not connected.

Troubleshooting

1. Make sure grid power is available.
2. Check (use multimeter) if AC side has voltage.
3. Check if breaker is good.
4. Check AC side connection is right or not (Make sure L/N cable are connected in the right place).
5. Make sure grid is connected and AC breaker turned ON.
6. If all is well, please try to turn off AC breaker and turn on again after 5 mins.

SEMS00CON0013

11 Maintenance

11.1 Power OFF the System



- When performing operation and maintenance on equipment in the system, please handle the Power OFF the System properly. Operating live equipment may cause equipment damage or electric shock DANGER.
- After the equipment is POWER OFF, the internal components Discharge require a certain amount of time. Please wait until the equipment is fully Discharge according to the time specified on the label.
- When closing Battery system, strictly adhere to the Battery system power off requirements to prevent damage to Battery system.

NOTICE

The breaker between Inverter and Battery, and the breaker between Battery system must be Installation in accordance with local laws and regulations.

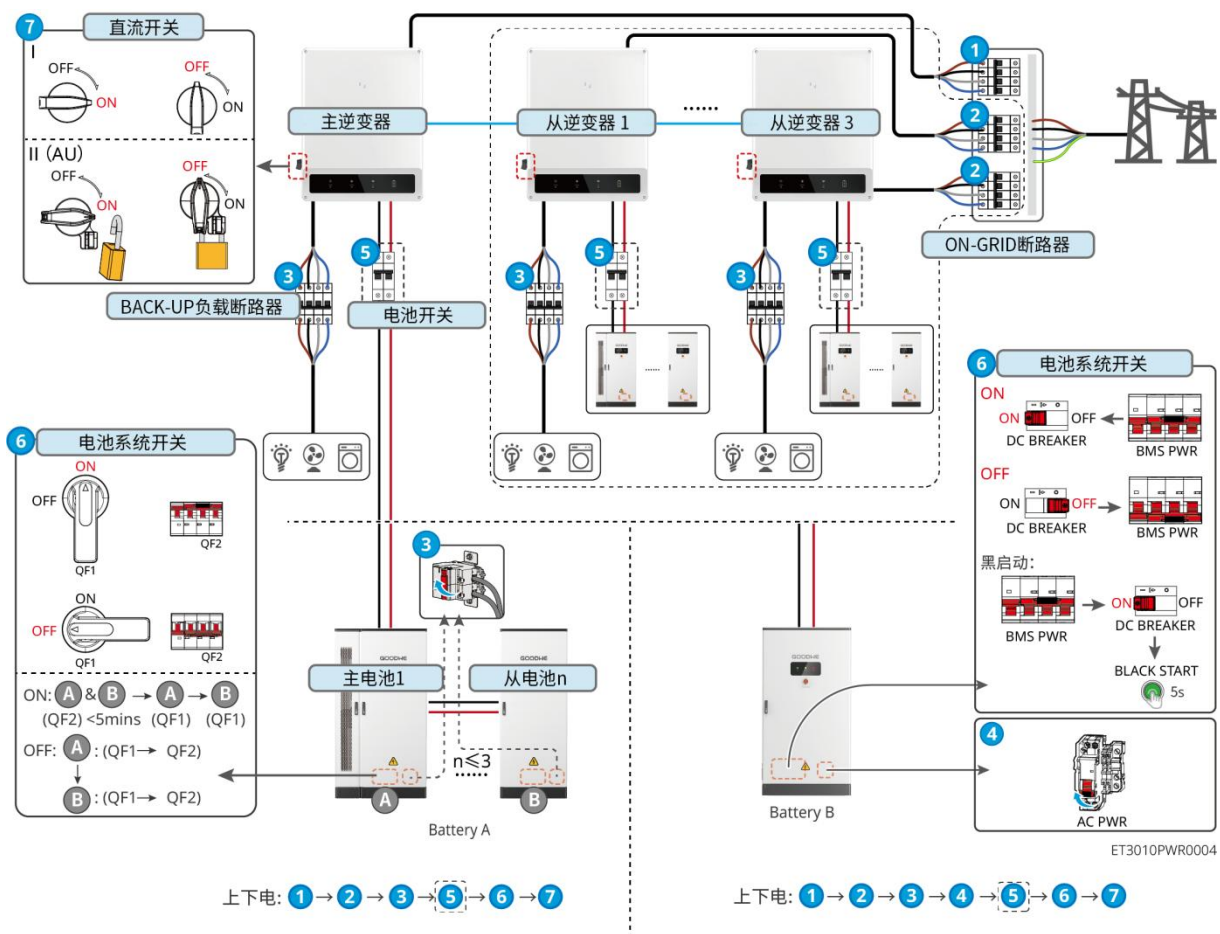

⑤: Optional in compliance with local laws and regulations.

11.2 Removing the Equipment



DANGER

- Make sure that the equipment is powered off.
- Wear proper personal protective equipment during operations.
- Use the PV tool and battery tool included in the package to remove the PV connector and battery connector.

Step 1 Power off the system.

Step 2 Label the cables connected in the system with tags indicating the cable type.

Step 3 Disconnect the inverter, battery and BACK-UP loads in the system.

Step 4 Remove the inverter from the mounting plate and remove the mounting plate.

Step 5 Remove the smart meter and smart dongle.

Step 6 Store the equipment properly. If the equipment needs to be used later, ensure that the storage conditions meet the requirements.

11.3 Disposing of the Equipment

If the equipment cannot work anymore, dispose of it according to the local disposal requirements for electrical equipment waste. The equipment cannot be disposed of together with household waste.

11.4 Routine Maintenance



DANGER

- Before maintaining the equipment, take necessary protective measures to prevent electric shock.
- During maintenance, ensure that both upstream and downstream switches of the equipment are disconnected.
- Strictly follow proper operating procedures during maintenance.



WARNING

- Contact after-sales service for help if you find any problems that may influence the battery or the hybrid inverter. Disassemble without permission is strictly forbidden.
- Contact after-sales service for help if the copper conductor is exposed. Do not touch or disassemble privately because high voltage danger exists.
- In case of other emergencies, contact the after-sales service as soon as possible. Operate following the instructions or wait for the after-sales service personnel.

Maintaining Item	Maintaining method	Maintaining Period	Maintaining purpose
System cleaning	<ol style="list-style-type: none"> 1. Check heat sink and the inlet/outlet for any foreign objects or dust. 2. Check if the Installation space meets the requirements, and ensure there is no debris accumulation around the equipment. 	Once half a year	Prevent heat dissipation fault
System grounding	<ol style="list-style-type: none"> 1. Check if the equipment Installation is secure and whether the fasteners screw are loose. 2. Check the equipment for any damage or deformation in appearance. 	Once 6-12 months	Verify the stability of the Installation equipment.
Electrical connection	Check whether the electrical connections are loose, and inspect the cables for any damage or exposed copper.	Once 6-12 months	Verify electrical connection reliability
Sealing	Check whether the cable entry hole Sealing of the equipment meets the requirements. If the gap is too large or unsealed, reseal it.	Once half a year	Verify that the machine is sealed and its waterproof performance is intact.
Fire protection maintenance	<ol style="list-style-type: none"> 1. Check whether the pressure gauge of the gas fire extinguishing device is in the green zone (safe range). If not, replace the gas cylinder. 2. Check whether the container valve switch is in the open state; if closed, it needs to be manually opened. 	Once half a year	Confirm fire protection reliability

	<ol style="list-style-type: none"> 3. Inspect the device for any mechanical damage, rust, paint peeling, or blurred nameplates. Replace components if serious issues are found. 4. Check whether the fire extinguishing agent container and the release pipe are firmly connected, and re-tighten if loose. 		
Air conditioning maintenance	<ol style="list-style-type: none"> 1. Check whether the power cable and communication cable are normal, and whether the voltage is normal. 2. Check whether there is a significant temperature difference between the inside and outside of the cabinet. 3. Check whether the fan and compressor are operating normally, and if there are any abnormal noises or vibrations. 4. Inspect the structure for any damage or deformation. 5. Check whether the internal and external circulation vents and the Protective coverP mesh screen are blocked, and inspect the condenser surface and heat exchanger fins for dust accumulation (in harsh environments, check every 3 months, as heavy dust, high 	Once half a year	Prevent heat dissipation fault

	Humidity, abundant willow catkins, or strong wind and sand can easily cause clogging).		
	6. Check if the drainage pipeline is deformed or clogged with dirt.		

Special Instructions for Condenser Cleaning:

1. Before operation, it is necessary to POWER OFF;
2. Use 6~7 bar compressed air or a water gun to clean the condenser from the outside of the cabinet;
3. Do not spray water directly at the wind turbine;
4. Clean dust from the water collection tray after washing;
5. Do not clean the inside of the cabinet with water to avoid electric shock;
6. Only rinse the upper air outlet; do not spray water directly on the intake fan. It is recommended to blow dry any residual water.
7. When cleaning and maintaining condensers and heat exchangers, do not use hot water or organic solvents such as gasoline for cleaning.

11.5 Troubleshooting

Perform troubleshooting according to the following methods. Contact the after-sales service if these methods do not work.





Collect the information below before contacting the after-sales service, so that the problems can be solved quickly.

1. Product information like serial number, software version, installation date, fault time, fault frequency, etc.
2. Installation environment, including weather conditions, whether the PV modules are sheltered or shadowed, etc. It is recommended to provide some photos and videos to assist in analyzing the problem.
3. Utility grid situation.

11.5.1 System Communication Troubleshooting

No.	Fault	Solutions
1	Unable to detect smart dongle wireless signal	<ol style="list-style-type: none"> 1. Ensure the Smart dongle power supply is normal, with the blue signal light flashing or steadily lit. 2. Ensure the smart device is within the communication range of Smart dongle. 3. Refresh the device list of the App. 4. Restart the Inverter.
2	Unable to connect to smart dongle wireless	<ol style="list-style-type: none"> 1. Ensure no other smart devices are connected to the Inverter WiFi signal.

	signal	<ol style="list-style-type: none"> Restart the Inverter and reconnect to the Inverter WiFi signal. If connecting to the Bluetooth signal, ensure that the Bluetooth pairing is successful.
3	Unable to locate Router SSID	<ol style="list-style-type: none"> Place the Router close to the Smart dongle, or add WiFi repeater devices to enhance the WiFi signal. Reduce the number of devices connected to the Router. Confirm whether Router is a 2.4G Router.
4	After all configurations are completed, the connection between Smart dongle and Router fails.	<ol style="list-style-type: none"> Restart Inverter. Check if the network name, encryption method, and password in the WiFi configuration are the same as those in Router. Restart the Router. Place the Router closer to the Smart dongle, or add WiFi repeater devices to enhance the WiFi signal.
5	After all configurations are completed, the Smart dongle fails to connect with the Server.	Restart Router and Inverter.
6	When using WiFi-Kit, unable to log in to 10.10.100.253.	<ol style="list-style-type: none"> Switch browsers such as Google Chrome, Firefox, IE, and Safari. Restart the Inverter and reconnect to WiFi.
7	When using the WiFi-Kit, the wireless Router network name cannot be found on the search page.	<ol style="list-style-type: none"> Move the Router closer to the Inverter, or add some WiFi repeater devices. Check if the number of channels in Router is greater than 13. If yes, please modify it to a lower number on the Router configuration page.
8	The GSA-***/GSB-*** cannot be found when using the 4G Kit-CN-G20 or 4G Kit-CN-G21 module.	<ol style="list-style-type: none"> Ensure that the Smart dongle power supply on the Inverter is functioning normally, with the blue signal light flashing or steadily illuminated. Ensure the smart device is within the communication range of Smart dongle. Refresh the device list of the App. Restart the Inverter.
9	Unable to connect to GSA-***/GSB-*** when using the 4G Kit-CN-G20 or 4G Kit-CN-G21 module.	<ol style="list-style-type: none"> Ensure Bluetooth is successfully paired. Restart Inverter and reconnect to GSA-***/GSB-***. Unpair GSA-***/GSB-*** from your phone's Bluetooth settings, then reconnect via the App.
10		Ensure the Smart dongle is properly connected to the Inverter.

	When using the 4G Kit-CN-G20 or 4G Kit-CN-G21 module, indicator flashes six times.	
11	Unable to recognize 4G Kit-CN-G20 or 4G Kit-CN-G21.	Restart Inverter.
12	 Ezlink indicator flashes twice	<ol style="list-style-type: none"> 1. Please ensure that Router is turned on. 2. When using LAN communication, ensure that the LAN cable is properly connected and the communication configuration is correct. Enable or disable the DHCP function based on actual conditions. 3. When using WiFi communication, ensure that the wireless network connection is normal and the wireless signal strength meets the requirements. Enable or disable the DHCP function based on actual conditions.
13	 Ezlink indicator flashes four times	Please ensure the communication stick is properly connected to the Router via WiFi or LAN, and the Router can access the internet normally. If the issue persists, please contact the after-sales service center.
14	 Ezlink indicator arc extinguishing	Please ensure that Inverter is power on. If the issue persists, please contact the after-sales service center.
15	 Ezlink indicator extinguishing	Please ensure that the Inverter has been power on.

11.5.2 Inverter Troubleshooting

Single inverter

No.	Fault	Cause	Solutions
1	Utility Loss	<ol style="list-style-type: none"> 1. Utility grid power fails. 2. The AC cable is disconnected, or the AC breaker is off. 	<ol style="list-style-type: none"> 1. The alarm is automatically cleared after the grid power supply is restored. 2. Check whether the AC cable is connected and the AC breaker is on.
2	Grid Overvoltage	The grid voltage exceeds the permissible range, or the duration of high voltage	<ol style="list-style-type: none"> 1. If the problem occurs occasionally, the utility grid may be abnormal temporarily. The inverter will recover automatically after detecting that the utility grid is normal.

		exceeds the requirement of HVRT.	<ol style="list-style-type: none"> 2. 2.If the problem occurs frequently, check whether the grid voltage is within the permissible range. <ul style="list-style-type: none"> ● Contact the local power company if the grid voltage exceeds the permissible range. ● Modify the overvoltage protection threshold, HVRT or disable the overvoltage protection function after obtaining the consent of the local power company if the grid frequency is within the permissible range. 3. Check whether the AC breaker and the output cables are connected securely and correctly if the problem persists.
3	Grid Rapid Overvoltage	The grid voltage is abnormal or ultra high.	<ol style="list-style-type: none"> 1. If the problem occurs occasionally, the utility grid may be abnormal temporarily. The inverter will recover automatically after detecting that the utility grid is normal. 2. If the problem occurs frequently, check whether the grid voltage is within the allowed range. <ul style="list-style-type: none"> ● Contact the local power company if the grid voltage exceeds the permissible range. ● Modify the grid overvoltage rapid protection threshold after obtaining the consent of the local power company if the grid voltage is within the permissible range.
4	Grid Undervoltage	The grid voltage is lower than the permissible range, or the duration of low voltage exceeds the requirement of LVRT.	<ol style="list-style-type: none"> 1. If the problem occurs occasionally, the utility grid may be abnormal temporarily. The inverter will recover automatically after detecting that the utility grid is normal. 2. 2.If the problem occurs frequently, check whether the grid voltage is within the permissible range. <ul style="list-style-type: none"> ● Contact the local power company if the grid voltage exceeds the permissible range. ● Modify the undervoltage protection threshold, LVRT or disable the undervoltage protection function after obtaining the consent of the local power company if the grid frequency is within the permissible range. 3. Check whether the AC breaker and the output cables are connected securely and correctly if

			the problem persists.
5	Grid 10min Overvoltage	The moving average of grid voltage in 10min exceeds the range of safety requirements.	<ol style="list-style-type: none"> 1. If the problem occurs occasionally, the utility grid may be abnormal temporarily. The inverter will recover automatically after detecting that the utility grid is normal. 2. If the problem occurs frequently, check whether the grid voltage is within the allowed range. <ul style="list-style-type: none"> ● Contact the local power company if the grid voltage exceeds the permissible range. ● Modify the grid overvoltage rapid protection threshold after obtaining the consent of the local power company if the grid voltage is within the permissible range.
6	Grid Overfrequency	Utility grid exception. The actual grid frequency exceeds the requirement of the local grid standard.	<ol style="list-style-type: none"> 1. If the problem occurs occasionally, the utility grid may be abnormal temporarily. The inverter will recover automatically after detecting that the utility grid is normal. 2. If the problem occurs frequently, check whether the grid frequency is within the permissible range. <ul style="list-style-type: none"> ● Contact the local power company if the grid frequency exceeds the permissible range. ● Modify the overfrequency protection threshold or disable the overfrequency protection function after obtaining the consent of the local power company if the grid frequency is within the permissible range.
7	Grid Underfrequency	Utility grid exception. The actual grid frequency is lower than the requirement of the local grid standard.	<ol style="list-style-type: none"> 1. If the problem occurs occasionally, the utility grid may be abnormal temporarily. The inverter will recover automatically after detecting that the utility grid is normal. 2. If the problem occurs frequently, check whether the grid frequency is within the permissible range. <ul style="list-style-type: none"> ● Contact the local power company if the grid frequency exceeds the permissible range. ● Modify the underfrequency protection threshold or disable the underfrequency protection function after obtaining the consent of the local power company if the grid frequency is within the permissible

			range. Or close Grid Underfrequency function. Grid Underfrequency
8	Grid Frequency Instability	Utility grid exception. The actual grid frequency change rate does not meet the requirement of the local grid standard.	<ol style="list-style-type: none"> 1. If the problem occurs occasionally, the utility grid may be abnormal temporarily. The inverter will recover automatically after detecting that the utility grid is normal. 2. If the problem occurs frequently, check whether the grid frequency is within the permissible range. <ul style="list-style-type: none"> ● Contact the local power company if the grid frequency exceeds the permissible range. ● Contact the dealer or the after-sales service if the grid frequency is within the permissible range.
9	Anti-islanding	The utility grid is disconnected. The utility grid is disconnected according to the safety regulations, but the grid voltage is maintained due to the loads.	<ol style="list-style-type: none"> 1. Check whether the utility grid is disconnected. 2. Contact the dealer or the after-sales service.
10	LVRT Undervoltage	Utility grid exception. The duration of the utility grid exception exceeds the set time of LVRT.	<ol style="list-style-type: none"> 1. If the problem occurs occasionally, the utility grid may be abnormal temporarily. The inverter will recover automatically after detecting that the utility grid is normal. 2. If the problem occurs frequently, check whether the grid frequency is within the permissible range. If not, contact the local power company. If yes, contact the dealer or the after-sales service.
11	HVRT Overvoltage	Utility grid exception. The duration of utility grid exception exceeds the set time of HVRT.	
12	Abnormal GFCI 30mA	The input insulation impedance becomes low when the inverter is working.	<ol style="list-style-type: none"> 1. If the problem occurs occasionally, it may be caused by a cable exception. The inverter will recover automatically after the problem is solved. 2. Check whether the impedance between the PV string and PE is too low if the problem occurs frequently or persists.
13	Abnormal GFCI 60mA		
14	Abnormal GFCI 150mA		
15	Abnormal GFCI		
16	Large DC of AC	The DC	<ol style="list-style-type: none"> 1. If the problem is caused by an external fault

	current L1		
17	Large DC of AC current L2	component of the output current exceeds the safety range or default range.	<p>like a utility grid exception or frequency exception, the inverter will recover automatically after solving the problem.</p> <p>2. If the problem occurs frequently and the PV station cannot work properly, contact the dealer or the after-sales service.</p>
18	Isolation Fail	<p>The PV string is short-circuited to PE.</p> <p>The PV system is in a moist environment and the cable is not well insulated to the ground.</p>	<p>1. Check whether the resistance of the PV string to PE exceeds 50kΩ. If no, check the short circuit point.</p> <p>2. Check whether the PE cable is connected correctly.</p>
19	Anti Reverse power Failure	Abnormal fluctuation of load	<p>1. If the exception is caused by an external fault, the inverter will recover automatically after solving the problem.</p> <p>2. If the problem occurs frequently and the PV station cannot work properly, contact the dealer or the after-sales service.</p>
20	Internal Comm Loss	<ol style="list-style-type: none"> 1. Frame format error 2. Parity checking error 3. Can bus offline 4. Hardware CRC error 5. Send (receive) control bit is receive (send). 6. Transmit to the unit that is not allowed. 	<p>Disconnect the AC output switch and DC input switch, then connect them 5 minutes later. Contact the dealer or the after-sales service if the problem persists.</p>
21	AC HCT Check abnormal	The sampling of the AC HCT is abnormal.	<p>Disconnect the AC output switch and DC input switch, then connect them 5 minutes later. Contact the dealer or the after-sales service if the problem persists.</p>
22	GFCI HCT Check abnormal	The sampling of the GFCI HCT is abnormal.	<p>Disconnect the AC output switch and DC input switch, then connect them 5 minutes later. Contact the dealer or the after-sales service if the problem persists.</p>
23	Relay Chk Fail	<ol style="list-style-type: none"> 1. Relay fault 2. The control circuit is 	<p>Disconnect the AC output switch and DC input switch, then connect them 5 minutes later. Contact the dealer or the after-sales service if the problem persists.</p>

		<p>abnormal.</p> <ol style="list-style-type: none"> The AC cable is connected improperly (like a virtual connection or short circuit) 	
24	Flash Fault	The internal Flash storage is abnormal.	Disconnect the AC output switch and DC input switch, then connect them 5 minutes later. Contact the dealer or the after-sales service if the problem persists.
25	AFCI Fault	<ol style="list-style-type: none"> The connection of DC string terminals is not firm. The DC cable wiring is damaged. 	Please check if the component connection cables are correctly connected according to the wiring requirements in the quick installation manual.
26	AFCI Self-test Fault	AFCI detection equipment is abnormal.	Disconnect the AC output switch and DC input switch, then connect them 5 minutes later. Contact the dealer or the after-sales service if the problem persists.
27	Cavity Overtemperature	<ol style="list-style-type: none"> The installation location of the inverter is not ventilated. The ambient temperature exceeds 60°C. Internal fan working abnormally 	<ol style="list-style-type: none"> Check whether the ventilation of the inverter installation location is good and whether the ambient temperature exceeds the maximum allowable ambient temperature range. If the ventilation is poor or the ambient temperature is too high, please improve the ventilation and heat dissipation conditions. Contact the dealer or after-sales service if both the ventilation and the ambient temperature are normal.
28	BUS Overvoltage	<ol style="list-style-type: none"> The PV voltage is too high. The sampling of the inverter BUS voltage is abnormal. 	Disconnect the AC output switch and DC input switch, then connect them 5 minutes later. Contact the dealer or the after-sales service if the problem persists.
29	PV Input Overvoltage	The PV array configuration is not correct. Too many PV panels are connected in series in the PV string.	Check the serial connection of the PV array. Make sure that the open circuit voltage of the PV string is not higher than the maximum operating voltage of the inverter.
30	PV Continuous	<ol style="list-style-type: none"> The PV 	Disconnect the AC output switch and DC input

	Hardware Overcurrent	configuration is not proper. 2. The hardware is damaged.	switch, then connect them 5 minutes later. Contact the dealer or the after-sales service if the problem persists.
31	PV Continuous Software Overcurrent	1. The PV configuration is not proper. 2. The hardware is damaged.	Disconnect the AC output switch and DC input switch, then connect them 5 minutes later. Contact the dealer or the after-sales service if the problem persists.
32	String1 PV String Reversed	The PV strings are connected reversely.	Check whether the PV1 and PV2 strings are connected reversely.
33	String1 PV String Reversed		

Parallel System

No.	Fault	Cause	Solutions
1	Abnormal parallel CAN communication	The parallel communication cable connection is abnormal, or an inverter in the parallel system is offline.	Check whether all the inverters are powered on and whether the parallel communication cables are firmly connected.
2	Communication indicator of the inverter and Ezlink indicator in error	Ezlink connection failed	<ol style="list-style-type: none"> 1. Check whether the WiFi signal is normal. If it is not, check whether the router works well. 2. Check whether Ezlink obtains IP successfully via APP. Execute the following actions if IP is not obtained: <ol style="list-style-type: none"> a. Reset the communication parameters via APP. b. Check whether the server connection is correct. c. Log in to the website mqtt.goodwepower.com in PC, check the analyzed IP address and obtain the connected server information.
3	Unable to log in to the parallel system interface in APP	Parallel networking failed	<ol style="list-style-type: none"> 1. Incorrect communication cable connection or unreliable cable connection cause communication failure. 2. Connect the smart meter and Ezlink module to the same master inverter to ensure the success rate of networking.

			<ol style="list-style-type: none"> 3. Check whether the inverter communication indicator is normal. If it is not, please check the individual inverter according to its own troubleshooting method. 4. If the above methods cannot solve the problem, please try to restart the inverter and get networking again.
4	Parallel IO check fail	Communication of parallel inverters in error	<ol style="list-style-type: none"> 1. Check whether the parallel communication cable is connected correctly and firmly. 2. If the communication cable connection is normal, it may be an internal communication failure. Please contact the dealer or After Sale Service.
5	Device offline displayed on APP	Communication failure or equipment failure	<ol style="list-style-type: none"> 1. Check whether the quantity of parallel machines in the system is the same with the actual connected ones. 2. If it is, get the SN of the corresponding offline inverter from the equipment list, and troubleshoot the corresponding inverter according to its user manual. 3. Check whether the communication connection of the equipment is normal, with no loose, aging or wrong connection, etc.

11.5.3 Battery Troubleshooting

- **GW60KWH-D-10, GW60KWH-D-10 (Extension)**

No.	Fault	Cause	Solutions
1	Battery overvoltage protection	Continue charging when battery is fully charged.	Stop charging, if the system is not restored automatically, contact professional technicians to restart the system.
2	Battery undervoltage protection	Continue discharging when the battery is fully discharged.	Stop discharging, if the system is not restored automatically, contact professional technicians to restart the system.
3	Battery overcurrent protection	The current exceeds the maximum system current during charging and discharging process.	If the system is not recovered automatically, contact professional technicians to restart the system.
4	Battery over temperature protection	Temperature too high during charging and discharging process.	Cool down, if the system is not automatically restored, contact professional technician to restart the

			system.
5	Battery low temperature protection	The temperature is too low during the charging and discharging process.	Warm up, if the system is not automatically restored, contact professional technician to restart the system.
6	Battery pole overtemperature protection	Temperature too high during charging and discharging process.	Cool down, if the system is not automatically restored, contact professional technician to restart the system.
7	Battery imbalance protection	Excessive temperature or voltage difference between individual cells.	Stop charging/discharging until the temperature difference recovers; perform balancing for large voltage difference.
8	Insulation resistance protection	The insulation resistance of the system is too low.	Check the grounding situation.
9	Precharge Failure	Pre-charge circuit components is damaged.	Check the pre-charging circuit components.
10	Fault on data collecting cables	Abnormal voltage, temperature, and current data collection cables.	Inspect the corresponding harness.
11	Relay open circuit	Relay fault	Replace relay.
12	Relay short circuit	Relay fault	Replace relay.
13	Cluster Fault	Slave cluster lost connection.	Check the reliability of the master and slave cables.
14	The PCS communication loss	Abnormal communication with PCS	Check the reliability of harness connections.
15	BMU communication failure	BCU and BMU communication harness abnormal.	Check the reliability of harness connections.
16	Air switch adhesion fault	Plastic shell air switch fault	Replace the plastic shell air switch.
17	Fault triggered by fire fighting system	Internal thermal runaway of the system	Contact the after-sales service.
18	Air conditioning fault	Fault occurs in the air conditioning system.	Contact the after-sales service.

● **GW61.4-BAT-AC-G10, GW92.1-BAT-AC-G10, GW102.4-BAT-AC-G10,
GW112.6-BAT-AC-G10**

No.	Fault	Cause	Solutions
1	Charge overvoltage 2	<ol style="list-style-type: none"> 1. Single voltage/Total pressure too high 2. voltage Acquisition Line Anomaly 	<ol style="list-style-type: none"> 1. Let the system sit powered off for 5 minutes, then restart and check if fault persists. 2. If fault is not restored, contact GoodWe after-sales service.
2	Charge overvoltage 3	<ul style="list-style-type: none"> ● Single voltage/Total pressure too high ● Abnormal collection line 	<ol style="list-style-type: none"> 1. Let the system stand for 5 minutes before shutting down, then restart to check if fault persists. 2. If the fault is not restored, contact GoodWe after-sales service.
3	Discharge undervoltage 3	<ul style="list-style-type: none"> ● Single voltage/Total Pressure Too Low ● voltage Acquisition Line Anomaly 	<ol style="list-style-type: none"> 1. Let the system stand idle for 5 minutes, then restart and check if fault persists. 2. Determine the working condition of Inverter, check if Battery charge is not being supplied due to issues like operating mode, and attempt to supply Battery charge via Inverter, observing whether fault is restored. 3. If fault is not restored, contact GoodWe after-sales service.
4	Discharge undervoltage 2	<ul style="list-style-type: none"> ● Single voltage/Total Pressure Too Low ● voltage Acquisition Line Anomaly 	<ol style="list-style-type: none"> 1. Let the system stand for 5 minutes before shutting down, then restart to check if fault persists. 2. Determine the working condition of Inverter, check if Battery charge is not being supplied due to issues like operating mode, and attempt to supply Battery charge via Inverter, then observe whether fault is restored. 3. If fault is not restored, contact GoodWe after-sales service.
5	Single overvoltage 2	<ul style="list-style-type: none"> ● Single voltage/Total pressure too high ● voltage Acquisition Line Anomaly 	<ol style="list-style-type: none"> 1. Let the system stand for 5 minutes before shutting down, then restart to check if fault persists. <p>If fault is not restored, contact GoodWe after-sales service.</p>
6	Single cell undervoltage 2	Single undervoltage	<ol style="list-style-type: none"> 1. Let the system stand idle for 5 minutes, then restart and check if fault persists. 2. Determine the working condition of Inverter, check if Battery charge is not being supplied due to issues like working mode, and attempt to supply

			Battery charge via Inverter, then observe whether fault is restored. 3. If fault is not restored, contact GoodWe after-sales service.
7	High differential pressure in single cells 2	High differential pressure in single cells	1. Restart Battery and wait for 12 hours. 2. If fault is not restored, contact GoodWe after-sales service.
8	Charge overcurrent 2	<ul style="list-style-type: none"> ● Chargecurrent is too large, Battery current limiting is abnormal: temperature and voltage value suddenly change. ● Inverter response anomaly 	<ol style="list-style-type: none"> 1. Let the system stand for 5 minutes before shutting down, then restart to check if fault persists. 2. Check whether the Inverter is set with an excessively large Power, causing it to exceed the rated operating current of the Battery.
9	Discharge overcurrent 2	<ul style="list-style-type: none"> ● Dischargecurrent is too large, Battery current limiting abnormality: sudden changes in temperature and SOC values ● Inverter response anomaly 	<ol style="list-style-type: none"> 3. If fault is not restored, contact GoodWe after-sales service.
10	Cell High Temperature 2	<ul style="list-style-type: none"> ● High temperature of single cell ● Temperature sensor abnormality 	<ol style="list-style-type: none"> 1. Let the system stand idle for 30 minutes before shutting down, then restart to check if fault persists. 2. If fault is not restored, contact GoodWe after-sales service.
11	Cell low temperature 2	<ul style="list-style-type: none"> ● Ambient temperature too low ● Temperature sensor abnormality 	<ol style="list-style-type: none"> 1. Standby shutdown for 30 minutes; after restarting, check if fault persists; 2. If fault is not restored, contact GoodWe after-sales service.
12	Charge Overtemperature 2	<ul style="list-style-type: none"> ● High temperature of single cell ● Temperature sensor abnormality 	<ol style="list-style-type: none"> 1. Standby shutdown for 30 minutes; after restarting, check if fault persists; 2. If fault is not restored, contact GoodWe after-sales service.
13	Charge Low Temperature 2	<ul style="list-style-type: none"> ● Ambient temperature too low ● Temperature sensor abnormality 	<ol style="list-style-type: none"> 1. Standby shutdown for 30 minutes; after restarting, check if fault persists; 2. If fault is not restored, contact GoodWe after-sales service.
14	Discharge Overtemperature 2	<ul style="list-style-type: none"> ● High temperature of single cell ● Temperature sensor 	<ol style="list-style-type: none"> 1. Standby shutdown for 30 minutes; after restarting, check if fault persists; 2. If fault is not restored, contact GoodWe

		abnormality	after-sales service.
15	Discharge Low Temperature 2	<ul style="list-style-type: none"> ● Ambient temperature too low ● Temperature sensor abnormality 	<ol style="list-style-type: none"> 1. Standby shutdown for 30 minutes; after restarting, check if fault persists; 2. If fault is not restored, contact GoodWe after-sales service.
16	Large single-body temperature difference 2	Large temperature difference in single unit	<ol style="list-style-type: none"> 1. Standby shutdown for 30 minutes; after restarting, check if fault persists; 2. If fault is not restored, contact GoodWe after-sales service.
17	Precharge failure	Precharge MOS closing failure	<ol style="list-style-type: none"> 1. Let the system stand for 5 minutes before shutting down, then restart to check if fault persists. 2. If fault is not restored, contact GoodWe after-sales service.
18	Battery tripping	Battery circuit breaker tripped	<ol style="list-style-type: none"> 1. Let it stand for 10 minutes, then close and restore. 2. If fault is not restored, contact GoodWe after-sales service.
19	Battery and Inverter communication failure	Communication failure between Battery and Inverter	<ol style="list-style-type: none"> 1. Verify the communication cable sequence and DC wiring for correctness, and ensure proper continuity. 2. Restart Inverter and Battery. 3. If fault is not restored, contact GoodWe after-sales service.
20	specific fault	Battery specific fault	Please contact the after-sales service center.
21	Cluster Combiner Box	Cluster disconnection Cluster connection failure	Check the reliability of the master-slave harness communication connection. Please contact the after-sales service center.
22	Application software	Software self-test failed	Please contact the after-sales service center.
23	Microelectronics fault	Electronic components	Please contact the after-sales service center.
24	Master control overload	Exceeding the power line capacity limit	Stop Charge. If it does not automatically recover, please contact professional technicians to restart the system.
25	SN anomaly	There is a Battery with the same SN.	Please contact the after-sales service center.
26	Circuit breaker anomaly	Abnormal tripping of molded case circuit breaker	Replace molded case circuit breaker

12 Technical Parameters

12.1 Inverter Parameters

Technical parameters	GW15K-ET	GW20K-ET	GW25K-ET	GW29.9K-ET	GW30K-ET
Battery Input Data					
Battery Type	Li-Ion	Li-Ion	Li-Ion	Li-Ion	Li-Ion
Nominal Battery Voltage (V)	500	500	500	500	500
Battery voltage range (V)	200~800	200~800	200~800	200~800	200~800
Start-up Voltage (V)	200	200	200	200	200
Number of Battery Input	1	1	2	2	2
Max. Continuous Charging Current (A)	50	50	50×2	50×2	50×2
Max. Continuous Discharging Current (A)	50	50	50×2	50×2	50×2
Max Charge Power (W)	15,000	20,000	25,000	30,000	30,000
Max Discharge Power (W)	15,000	20,000	25,000	30,000	30,000
PV String Input Data					
Max. Input Power (W) ^{*1}	22,500	30,000	37,500	45,000	45,000
Max. Input Voltage (V) ^{*2}	1000	1000	1000	1000	1000
MPPT Operating Voltage Range (V)	200~850	200~850	200~850	200~850	200~850
MPPT Voltage Range at Nominal Power (V)	400~850	400~850	450~850	450~850	450~850
Start-up Voltage (V)	200	200	200	200	200
Nominal Input Voltage (V)	620	620	620	620	620
Max. Input Current per MPPT (A)	30	30	30	30	30
Max. Short Circuit Current per MPPT (A)	38	38	38	38	38
Max. Backfeed Current to The Array (A)	0	0	0	0	0
Number of MPPT	2	2	3	3	3
Number of Strings per MPPT	2/2	2/2	2/2/2	2/2/2	2/2/2
AC Output Data (On-grid)					
Nominal Output Power (W)	15,000	20,000	25,000	29,900	30,000

Max. Output Power (W)	15,000	20,000	25,000	29,900	30,000
Nominal Output Power at 40 °C(W) *14	15,000	20,000	25,000	29,900	30,000
Max. Output Power at 40 °C (W)*14	15,000	20,000	25,000	29,900	30,000
Nominal Apparent Power Output to Utility Grid (VA)	15,000	20,000	25,000	29,900	30,000
Max. Apparent Power Output to Utility Grid (VA)*3 *15	16,500	22,000	27,500	29,900	33,000
Nominal Apparent Power from Utility Grid(VA)	15,000	20,000	25,000	30,000	30,000
Max. Apparent Power from Utility Grid (VA) *12	15,000	20,000	25,000	30,000	30,000
Nominal Output Voltage (V)	380/400, 3L/N/PE	380/400, 3L/N/PE	380/400, 3L/N/PE	380/400, 3L/N/PE	380/400, 3L/N/PE
Output Voltage Range (V)*4	0~300	0~300	0~300	0~300	0~300
Nominal AC Grid Frequency (Hz)	50/60	50/60	50/60	50/60	50/60
AC Grid Frequency Range (Hz)	45~65	45~65	45~65	45~65	45~65
Max. AC Current Output to Utility Grid (A) *11	23.9	31.9	39.9	43.3	47.8
Max. AC Current From Utility Grid (A) *13	22.7	30.3	37.9	45.3	45.5
Nominal AC Current From Utility Grid (A)	21.7@230V 22.7@220V	29.0@230V 30.3@220V	36.2@230V 37.9@220V	43.3@230V 45.3@220V	43.5@230V 45.5@220V
Max. Output Fault Current (Peak and Duration) (A)	241.5A@126 ms	241.5A@126 ms	241.5A@126 ms	241.5A@126 ms	241.5A@126 ms
Inrush Current (Peak and Duration) (A)	264A@53us	264A@53us	264A@53us	264A@53us	264A@53us
Nominal Output Current (A)*5	21.7	29.0	36.2	43.3	43.5
Power Factor	~1 (Adjustable from 0.8 leading~0.8 lagging)	~1 (Adjustable from 0.8 leading~0.8 lagging)	~1 (Adjustable from 0.8 leading~0.8 lagging)	~1 (Adjustable from 0.8 leading~0.8 lagging)	~1 (Adjustable from 0.8 leading~0.8 lagging)
Max. Total Harmonic Distortion	≤3.05%	≤3.05%	≤3.05%	≤3.05%	≤3.05%
Maximum Output Overcurrent Protection (A)	94	94	94	94	94

AC Output Data (Back-up)					
Back-up Nominal Apparent Power (VA)	15,000	20,000	25,000	29,900	30,000
Max. Output Apparent Power without Grid(VA)* ⁶	15,000(18,000@60s , 24,000@3s)	20,000(24,000@60s , 32,000@3s)	25,000(30,000@60s)	30,000(36,000@60s)	30,000(36,000@60s)
Max. Output Apparent Power with Grid (VA)	15,000	20,000	25,000	29,900	30,000
Nominal Output Current (A)	22.7	30.3	37.9	45.5	45.5
Max. Output Current (A)	22.7(27.3@60s, 36.4@3s)	30.3(36.4@60s, 48.5@3s)	37.9(45.5@60s)	45.5(54.5@60s)	45.5(54.5@60s)
Max. Output Fault Current (Peak and Duration) (A)	94	94	94	94	94
Inrush Current (Peak and Duration) (A)	264@53us	264@53us	264@53us	264@53us	264@53us
Maximum Output Overcurrent Protection (A)	94	94	94	94	94
Nominal Output Voltage (V)	380/400	380/400	380/400	380/400	380/400
Nominal Output Frequency (Hz)	50/60	50/60	50/60	50/60	50/60
Output THDv (@Linear Load)	<3%	<3%	<3%	<3%	<3%
Efficiency					
Max. Efficiency	98.0%	98.0%	98.0%	98.0%	98.0%
European Efficiency	97.5%	97.5%	97.5%	97.5%	97.5%
Max. Battery to AC Efficiency	97.5%	97.5%	97.5%	97.5%	97.5%
MPPT Efficiency	99.9%	99.9%	99.9%	99.9%	99.9%
Protection					
PV String Current Monitoring	Integrated	Integrated	Integrated	Integrated	Integrated
PV Insulation Resistance Detection	Integrated	Integrated	Integrated	Integrated	Integrated
Residual Current Monitoring	Integrated	Integrated	Integrated	Integrated	Integrated
PV Reverse Polarity Protection	Integrated	Integrated	Integrated	Integrated	Integrated
Battery Reverse Polarity Protection	Integrated	Integrated	Integrated	Integrated	Integrated
Anti-islanding Protection	Integrated	Integrated	Integrated	Integrated	Integrated
AC Overcurrent	Integrated	Integrated	Integrated	Integrated	Integrated

Protection					
AC Short Circuit Protection	Integrated	Integrated	Integrated	Integrated	Integrated
AC Overvoltage Protection	Integrated	Integrated	Integrated	Integrated	Integrated
DC Switch ^{*7}	Integrated	Integrated	Integrated	Integrated	Integrated
DC Surge Protection	Type II	Type II	Type II	Type II	Type II
AC Surge Protection	Type III	Type III	Type III	Type III	Type III
AFCI ^{*16}	Optional	Optional	Optional	Optional	Optional
Rapid Shutdown	Optional	Optional	Optional	Optional	Optional
Remote Shutdown	Integrated	Integrated	Integrated	Integrated	Integrated
General Data					
Operating Temperature Range (°C)	-35~+60	-35~+60	-35~+60	-35~+60	-35~+60
Operating Environment	Outdoor	Outdoor	Outdoor	Outdoor	Outdoor
Relative Humidity	0 ~ 95%	0 ~ 95%	0 ~ 95%	0 ~ 95%	0 ~ 95%
Max. Operating Altitude (m)	4000	4000	4000	4000	4000
Cooling Method	Smart Fan Cooling	Smart Fan Cooling	Smart Fan Cooling	Smart Fan Cooling	Smart Fan Cooling
Display	LED, WLAN+APP	LED, WLAN+APP	LED, WLAN+APP	LED, WLAN+APP	LED, WLAN+APP
Communication with BMS	RS485 / CAN	RS485 / CAN	RS485 / CAN	RS485 / CAN	RS485 / CAN
Communication with Meter	RS485	RS485	RS485	RS485	RS485
Communication with Portal	WiFi+LAN+Bluetooth	WiFi+LAN+Bluetooth	WiFi+LAN+Bluetooth	WiFi+LAN+Bluetooth	WiFi+LAN+Bluetooth
Weight (kg)	48	48	54	54	54
Dimension W×H×D (mm)	520×660×220	520×660×220	520×660×220	520×660×220	520×660×220
Noise Emission (dB)	<45	<45	<45	<60	<60
Topology	Non-isolated	Non-isolated	Non-isolated	Non-isolated	Non-isolated
Self-consumption at Night (W) ^{*8}	<15	<15	<15	<15	<15
Ingress Protection Rating	IP66	IP66	IP66	IP66	IP66

DC Connector	Stäubli Electrical Connectors AG	Stäubli Electrical Connectors AG	Stäubli Electrical Connectors AG	Stäubli Electrical Connectors AG	Stäubli Electrical Connectors AG
AC Connector	OT	OT	OT	OT	OT
Environmental Category	4K4H	4K4H	4K4H	4K4H	4K4H
Pollution Degree	III	III	III	III	III
Overvoltage Category	DC II / AC III	DC II / AC III	DC II / AC III	DC II / AC III	DC II / AC III
Protective Class	I	I	I	I	I
Storage Temperature (°C)	-45~+85	-45~+85	-45~+85	-45~+85	-45~+85
The Decisive Voltage Class (DVC)	Battery: C PV: C AC: C Com: A	Battery: C PV: C AC: C Com: A	Battery: C PV: C AC: C Com: A	Battery: C PV: C AC: C Com: A	Battery: C PV: C AC: C Com: A
Mounting Method	Wall Mounted	Wall Mounted	Wall Mounted	Wall Mounted	Wall Mounted
Active Anti-islanding Method	AFDPF + AQDPF *9	AFDPF + AQDPF *9	AFDPF + AQDPF *9	AFDPF + AQDPF *9	AFDPF + AQDPF *9
Type of Electrical Supply System	Three phase Grid	Three phase Grid	Three phase Grid	Three phase Grid	Three phase Grid
Country of Manufacture	China	China	China	China	China
Certification *10					
Grid Standards	VDE-AR-N 4105, EN50549-1				
Safety Regulation	IEC62109-1&2				
EMC	EN61000-6-1, EN61000-6-2, EN61000-6-3, EN61000-6-4				

*1: In Australia, for most of the PV module, the max.Input power can achieve 2*Pn, Such as the max.input power of GW15K-ET can achieve 30000W. Besides, Max. Input Power, not continuous for 1.5*normal power.

*2: For 1000V system, Maximum operating voltage is 950V.

*3: According to the local grid regulation.

*4: Output Voltage Range: phase voltage.

*5: For 380V grid, the Nominal Output Current is 22.7A for GW15K-ET, 30.3A for GW20K-ET, 37.9A for GW25K-ET, 45.3A GW29.9K-ET, and 45.5A for GW30K-ET.

*6: Can be reached only if PV and battery power is enough.

*7: DC Switch: GHX6-55P (for Australia).

*8: No Back-up Output.

*9: AFDPF: Active Frequency Drift with Positive Feedback, AQDPF: Active Q Drift with Positive

Feedback.

*10: Not all certifications & standards listed, check the official website for details.

*11: For 380V grid, the Max. AC Current Output to Utility Grid is 25A for GW15K-ET, 33.3A for GW20K-ET, 41.7A for GW25K-ET, 49.8A for GW29.9K-ET, 50A for GW30K-ET.

*12: When the load is connected to the inverter's backup port, the Max. Apparent Power from Utility Grid can reach to 22.5K for GW15K-ET, 30K for GW20k-ET, 33K for GW25K-ET, 33K for GW29.9K-ET, and 33K for GW30K-ET respectively.

*13: When the load is connected to the inverter's backup port, the Max. AC Current From Utility Grid can reach to 34A for GW15K-ET, 45A for GW20k-ET, 50A for GW25K-ET, 50A for GW29.9K-ET, and 50A for GW30K-ET respectively.

*14: Nominal Output Power at 40 °C(W) and Max. Output Power at 40 °C (W) are only for Brazil.

*15: For Austria, Max. Output Power (W) is 15K for GW15K-ET, 20K for GW20K-ET, 25K for GW25K-ET, 29.9K GW29.9K-ET, and 30K for GW30K-ET.

12.2 Battery Parameters

- GW60KWH-D-10、GW60KWH-D-10(Extension)

Technical Parameters	GW60KWH-D-10	GW60KWH-D-10(EXTENSION)
Battery Data		
Usable Energy (kWh) ^{*1}	60	
Cell Type	LFP (LiFePO4)	
Cell Capacity (Ah)	100	
Pack Nominal Energy (kWh)	5.76	
Number of Packs	11	
Nominal Voltage (V)	633.6	
Operating Voltage Range (V)	554.4~712.8	
Max. Charge/ Discharge Current (A) ^{*2}	96	
Max. Charge/ Discharge Rate ^{*2}	0.96C	
Cycle Life ^{*3}	≥5000	
Depth of Discharge	100%	
Efficiency		
Round-trip Efficiency	95%	
General Data		
Operating Temperature Range (°C)	Charge: 0~+55; Discharge: -25~+55	
Storage Temperature (°C)	0~+35(< One Year); -20~0(≤One Month); +35~+40(≤One Month)	
Relative Humidity	0~95%	
Max. Operating Altitude (m)	3000	
Heating & Cooling	Air Conditioner	
User Interface	LED indicator	
Communication Interface	CAN	
Communication Protocol	CAN	
Weight (kg)	appro.1029.5	appro.972
Dimension (W×H×D mm)	1108×2050× 1111.5	808×2050× 1111.5

Ingress Protection Rating	IP55(Battery Cabinet)
Anti-Corrosion ^{*4}	C4 (Optional upgrade to C5)
Fire Suppression	Perfluoro
Certification^{*5}	
Safety Regulation	IEC62619/63056, IEC60730-1, IEC/EN62477-1, IEC62040-1
EMC	EN IEC61000-6-1, EN IEC61000-6-2, EN IEC61000-6-3, EN IEC61000-6-4
<p>*1: Test conditions, 100% DOD, 0.5C charge & discharge at +25±2 °C for battery system at beginning life. System Usable Energy may vary with different Inverter.</p> <p>*2: Actual Dis-/Charge Current and power derating will occur related to Cell Temperature and SOC.And, Max C-rate continuous time is affected by SOC, Cell Temperature, Atmosphere environment temperature ,Air-conditioner refrigeration capacity.</p> <p>*3: Based on Cell test condition of 25±2°C, 0.5C/0.5C and 80% EOL.</p> <p>*4: Excluding locks.</p> <p>*5: Not all certifications & standards listed, check the official website for detail.</p>	

- **GW61.4-BAT-AC-G10, GW92.1-BAT-AC-G10, GW102.4-BAT-AC-G10, GW112.6-BAT-AC-G10**

Technical Data	GW61.4-BAT-AC-G10	GW92.1-BAT-AC-G10	GW102.4-BAT-AC-G10	GW112.6-BAT-AC-G10
Battery System				
Cell Type	LFP (LiFePO4)			
Cell Capacity (Ah)	100			
Rated Capacity (Ah)	200			
Pack Type/model	GW10.2-PACK-ACI-G10			
Pack Nominal Energy (kWh)	10.24			
Pack Configuration	2P96S	2P144S	2P160S	2P176S
Pack Weight (kg)	< 90			
Number of Packs	6	9	10	11
Nominal Energy (kWh)	61.4	92.1	102.4	112.6
Usable Energy (kWh) ^{*1}	60	90	100	110
Nominal Voltage (V)	307.2	460.8	512	563.2
Operating Voltage Range (V)	275.52~346.56	413.28~519.84	459.2~577.6	505.12~635.36
Charging Operating	-20~+55			

Temperature Range (°C)				
Discharging Operating Temperature Range (°C)	-20~+55			
Max. Charge/ Discharge Current (A) *2	180/220			
Max. Charge/ Discharge Rate *2	0.9C/1.1C			
Max. Charge/ Discharge power (kW) *2	55.2/67.5	82.9/101.3	92.1/112.6	101.3/123.9
Cycle Life	≥6000 times until 70% SOH under 25±2°C.0.5C and 100% DOD			
Depth of Discharge	100%			
Efficiency				
Round-trip Efficiency	96%@100%DOD,0.2C,25±2°C			
General Data				
Operating Temperature Range (°C)	-20~55°C			
Storage Temperature (°C)	+35°C~+45°C (< 6 Months); -20°C~+35°C (< 1 Year)			
Relative Humidity	0 ~ 100% (Condensationless)			
Max. Operating Altitude (m)	4000			
Cooling Method	Air Conditioner			
User Interface	LED			
Communication	CAN (RS485 Optional)			
Weight (kg)	< 950	< 1220	< 1310	< 1400
Dimension (W×H×Dmm)	1055*2000*1055			
Noise Emission (dB)	≤70			
Ingress Protection Rating	IP55			
Anti-corrosion Class	C4 (C5-M Optional)			
Fire safety equipment	Aerosol (Pack&Cabinet Level)			
Certification *4				
Safety Regulation	IEC62619/IEC63056/IEC60730/IEC62477/VDE2510/ISO13849 IEC62040/N140/EU 2023/1542/UN38.3			
EMC	IEC/EN61000-6-1/2/3/4			
<p>1. Test conditions, 100% DOD, 0.2C charge & discharge at +25±2 °C for battery system at beginning life. System Usable Energy may vary with system configuration.</p> <p>2. Actual Dis-/Charge Current and power derating will occur related to Cell Temperature and SOC. And, Max C-rate continuous time is affected by SOC, Cell Temperature, Atmosphere environment</p>				

temperature .

3. Aerosol (Cabinet Level) before May 30th, Aerosol (Pack&Cabinet Level) after May 30th
4. Not all certifications & standards listed, check the official website for detail.

12.3 Smart Meter Parameters

Technical parameters			GM3000
Input	Grid		Three-phase
	Voltage	Nominal Voltage-Line to N (Vac)	230
		Nominal Voltage-Line to Line (Vac)	400
		Voltage Range	0.88Un-1.1Un
		Nominal AC Grid Frequency (Hz)	50/60
	Current	Current Transformer Ratio	120A:40mA
Number of Current Transformers		3	
Communication			RS485
Communication Distance (m)			1000
User interface			3 LED, Reset button
Accuracy	Voltage/Current		Class 1
	Active Energy		Class 1
	Reactive Energy		Class 2
Power Consumption(W)			<3
Mechanical	Dimensions (W×H×D mm)		36*85*66.5
	Housing		2 modules
	Weight (g)		450
	Mounting		Din rail
Environment	Ingress Protection Rating		IP20
	Operating Temperature Range (°C)		-25~60
	Storage Temperature Range(°C)		-30~70
	Relative Humidity (non-condensing)		0~95%
	Max. Operating Altitude (m)		2000

Model	GMK330	GM330
Measuring range		
Supported Grid Types	Three-phase, split-phase, single-phase	Three-phase, split-phase, single-phase
Line to Line Voltage Range(Vac)	156~457	172~817
Line to N Voltage Range (Vac)	90~264	100~472

Nominal AC Grid Frequency (Hz)	50/60	50/60
Current Transformer Ratio	200A:50mA/ 120A:40mA	nA:5A
Number of Current Transformers	3	/
Accuracy		
Voltage/Current	Class 0.5	Class 0.5
Active Energy	Class 0.5	Class 0.5
Reactive Energy	Class 1	Class 1
Communication		
Communication method	RS485	RS485
Communication Distance (m/ft)	1000	1000
General		
Dimensions (W×H×D mm/in)	72*85*72	72*85*72
Housing	4 modules	4 modules
Weight (g/lb)	240	240
Mounting	Din rail	Din rail
User interface	4 LED, Reset button	4 LED, Reset button
Power Consumption(W)	<5	<5
Environment		
Ingress Protection Rating	IP20	IP20
Operating Temperature Range (°C/°F)	-30~+70	-30~+70
Storage Temperature Range (°C/°F)	-30~+70	-30~+70
Relative Humidity (non-condensing)	0 ~ 95%	0 ~ 95%
Max. Operating Altitude (m/ft)	3000	3000

12.4 Smart Dongle Parameters

Technical parameters		WiFi/LAN Kit-20
Input voltage (V)		5
Power Consumption (W)		≤3
Connection Interface		USB
Communication	Ethernet Interface	10M/100Mbps Self-adaption
	WLAN	IEEE 802.11 b/g/n @2.4 GHz
	Bluetooth	Bluetooth V4.2 BR/EDR Bluetooth LE Specification
Mechanical Parameters	Dimensions (W×H×D mm)	48.3*159.5*32.1
	Weight (g)	82
	Ingress Protection Rating	IP65
	Installation	Plug and Play
Operating Temperature Range (°C)		-30 - 60°C
Storage Temperature Range (°C)		-40 - 70°C
Relative Humidity		0-95%
Max. Operating Altitude (m)		4000

Technical parameters	Wi-Fi Kit
General Data	
Max. Inverters Supported	1
Connection Interface	USB
Installation	Plug and Play
Indicator	LED Indicator
Dimensions (W×H×D mm)	49*96*32
Weight(g)	59

Ingress Protection Rating	IP65
Power Consumption (W)	2
Operating Temperature Range (°C)	-30 - 60°C
Storage Temperature Range (°C)	-40 - 70°C
Relative Humidity	0-100% (non-condensing)
Max. Operating Altitude (m)	4000
Wireless Parameter	
Supported Standards & Frequencies	802.11b/g/n(2.412G-2.472G)
Operating Mode	AP/STA/AP+STA

Technical parameters	Ezlink3000
General Data	
Connection Interface	USB
Ethernet Interface	10M/100M Ethernet Communication distance ≤ 100m
Installation	Plug and Play
Indicator	LED Indicator
Dimensions (W×H×D mm)	49*153*32
Weight (g)	130
Ingress Protection Rating	IP65
Power Consumption (W)	≤2W (typical)
Operating Mode	STA
Wireless Parameter	
Bluetooth Communication	Bluetooth 5.1
WiFi Communication	802.11b/g/n(2.412GHz-2.484GHz)
Environment	
Operating Temperature Range (°C)	-30 - 60°C
Storage Temperature Range (°C)	-30 - 70°C
Relative Humidity	0-100% (non-condensing)

Max. Operating Altitude (m)	4000
-----------------------------	------

Technical parameters	4G Kit-CN	LS4G Kit-CN
General Data		
Max. Number of Connected Devices	1	
Connection Interface	USB	
Installation	Plug and Play	
Indicator	LED	
Dimensions (W×H×D mm)	49*96*32	
SIM card size (mm)	15*12	
Ingress Protection Rating	IP65	
Power Consumption (W)	<4	
Operating Temperature Range (°C)	-30~60°C	
Storage Temperature Range (°C)	-40~70°C	
Relative Humidity	0-100% (non-condensing)	
Max. Operating Altitude (m)	4000	
Wireless Parameter		
LTE-FDD	B1/B3/B5/B8	
LTE-TDD	B34/B38/B39/B40/B41	
GNSS positioning	B3/B8	

Technical parameters	4G Kit-CN-G20	4G Kit-CN-G21
General Data		
Max. Number of Connected Devices	1	1
Connection Interface	USB	USB
Installation	Plug and Play	Plug and Play
Indicator	LED	LED

Dimensions (W×H×D mm)	48.3*95.5*32.1	48.3*95.5*32.1
SIM card size (mm)	15*12	15*12
Ingress Protection Rating	IP66	IP66
Weight (g)	87g	87g
Power Consumption (W)	<4	<4
Operating Temperature Range (°C)	-30~+65°C	-30~+65°C
Storage Temperature Range (°C)	-40~+70°C	-40~+70°C
Relative Humidity	0-100%	0-100%
Max. Operating Altitude (m)	4000	4000
Wireless Parameter		
LTE-FDD	B1/B3/B5/B8	B1/B3/B5/B8
LTE-TDD	B34/B39/B40/B41	B34/B39/B40/B41
GNSS positioning	/	Beidou, GPS

13 Appendix

13.1 FAQ

13.1.1 How to Perform Meter/CT Detection?

Meter/CT detection is used to auto-check if the Smart Meter and CT are connected in the right way and their working status.

Step 1 Tap **Home > Settings > Meter/CT Assisted Test to set the function.**

Step 2 Tap **Start Test** to start test. Check Test Result after test.

13.1.2 How to Upgrade Firmware Version

Check and upgrade the DSP version, ARM version, BMS version, AFCI version of the inverter, or firmware version of the communication module. Some devices do not support upgrading the firmware version through SolarGo app.

Method I:

If the Firmware Upgrade dialog box pops up once logging into the app, click Firmware Upgrade to directly go to the firmware information page.

When prompted by a red dot on the right of the Firmware Information, click to get the firmware update information.

During the upgrade process, ensure that the network is stable and the device remains connected to SolarGo, otherwise the upgrade may fail.

Step 1 Tap **Home > Settings > Firmware Upgrade** to check the firmware version. If the **Firmware Upgrade** dialog box pops up once logging into the app, click Firmware Upgrade to directly go to the firmware information page.

Step 2 (Optional) Tap **Check For Update** to check whether there is a latest version to be updated.

Step 3 Tap **Firmware Upgrade** as prompted to enter the firmware upgrade page.

Step 4 (Optional) Tap **Learn More** to check the firmware related information, such as Current Version, New Version, Update Record, etc.

Step 5 Tap **Upgrade** and follow the prompts to complete the upgrading.

Method II:

The automatic upgrade function is allowed only when a WiFi/LAN Kit-20 smart dongle is applied, and the module firmware version is V2.0.1 and above.

After enabling the auto-upgrade function, if there is any update and the device is connected to the network, the smart dongle firmware version can be automatically upgraded.

Step 1 Tap **Home > Settings > Firmware Upgrade** to check the firmware version.

Step 2 Enable or disable the **Automatic Upgrade** based on actual needs.

13.2 Acronyms and Abbreviations

U_{batt}	Battery Voltage Range
$U_{batt,r}$	Nominal Battery Voltage
$I_{batt,max (C/D)}$	Max. Continuous Charging Current Max. Continuous Discharging Current
$E_{C,R}$	Rated Energy
U_{DCmax}	Max. Input Voltage
U_{MPP}	MPPT Operating Voltage Range
$I_{DC,max}$	Max. Input Current per MPPT
$I_{SC PV}$	Max. Short Circuit Current per MPPT
$P_{AC,r}$	Nominal Output Power
$S_r (to grid)$	Nominal Apparent Power Output to Utility Grid
$S_{max (to grid)}$	Max. Apparent Power Output to Utility Grid
$S_r (from grid)$	Nominal Apparent Power from Utility Grid
$S_{max (from grid)}$	Max. Apparent Power from Utility Grid
$U_{AC,r}$	Nominal Output Voltage
$f_{AC,r}$	Nominal AC Grid Frequency
$I_{AC,max(to grid)}$	Max. AC Current Output to Utility Grid
$I_{AC,max(from grid)}$	Max. AC Current From Utility Grid
P.F.	Power Factor
S_r	Back-up Nominal apparent power
S_{max}	Max. Output Apparent Power (VA) Max. Output Apparent Power without Grid
$I_{AC,max}$	Max. Output Current
$U_{AC,r}$	Nominal Output Voltage
$f_{AC,r}$	Nominal Output Frequency
$T_{operating}$	Operating Temperature Range
$I_{DC,max}$	Max. Input Current
U_{DC}	Input Voltage
$U_{DC,r}$	DC Power Supply
U_{AC}	Power Supply/AC Power Supply
$U_{AC,r}$	Power Supply/Input Voltage Range
$T_{operating}$	Operating Temperature Range
P_{max}	Max Output Power
P_{RF}	TX Power
P_D	Power Consumption

$P_{AC,r}$	Power Consumption
$F_{(Hz)}$	Frequency
$I_{SC,PV}$	Max. Input Short Circuit Current
$U_{dcmin}-U_{dcmax}$	Range of input Operating Voltage
$U_{AC,rang(L-N)}$	Power Supply Input Voltage
$U_{sys,max}$	Max System Voltage
$H_{altitude,max}$	Max. Operating Altitude
PF	Power Factor
THDi	Total Harmonic Distortion of Current
THDv	Total Harmonic Distortion of Voltage
C&I	Commercial & Industrial
SEMS	Smart Energy Management System
MPPT	Maximum Power Point Tracking
PID	Potential-Induced Degradation
Voc	Open-Circuit Voltage
Anti PID	Anti-PID
PID Recovery	PID Recovery
PLC	Power-line Communication
Modbus TCP/IP	Modbus Transmission Control / Internet Protocol
Modbus RTU	Modbus Remote Terminal Unit
SCR	Short-Circuit Ratio
UPS	Uninterruptible Power Supply
ECO mode	Economical Mode
TOU	Time of Use
ESS	Energy Storage System
PCS	Power Conversion System
SPD	Surge Protection Device
DRED	Demand Response Enabling Device
RCR	Ripple Control Receiver
AFCI	AFCI
GFCI	Ground Fault Circuit Interrupter
RCMU	Residual Current Monitoring Unit
FRT	Fault Ride Through
HVRT	High Voltage Ride Through
LVRT	Low Voltage Ride Through
EMS	Energy Management System

BMS	Battery Management System
BMU	Battery Measure Unit
BCU	Battery Control Unit
SOC	State of Charge
SOH	State of Health
SOE	State Of Energy
SOP	State Of Power
SOF	State Of Function
SOS	State Of Safety
DOD	Depth of discharge

13.3 Term Explanation

Overvoltage category definition

Category I: Applies to equipment connected to a circuit where measures have been taken to reduce transient overvoltage to a low level.

Category II: Applies to equipment not permanently connected to the installation. Examples are appliances, portables tools and other plug-connected equipment.

Category III: Applies to a fixed equipment downstream, including the main distribution board. Examples are switchgear and other equipment in an industrial installation.

Category IV: Applies to equipment permanently connected at the origin of an installation (upstream of the main distribution board). Examples are electricity meters, primary over-current protection equipment and other equipment connected directly to outdoor open lines.

Moisture location category definition

Environmental Parameters	Level		
	3K3	4K2	4K4H
Moisture Parameters	0~+40°C	-33~+40°C	-33~+40°C
Temperature Range	15% - 100%	15% - 100%	15% - 100%

Environment category definition

Outdoor: Ambient Temperature: -25~+60°C, applied to Pollution Degree 3 environment.

Indoor Unconditioned: Ambient Temperature: -25~+40°C, applied to Pollution Degree 3 environment.

Indoor conditioned: Ambient Temperature: 0~+40°C, applied to Pollution Degree 2 environment.

Pollution degree definition

Contamination Class I: No contamination or only dry, non-conductive contamination;

Pollution Degree II: Normally only non-conductive pollution occurs. Occasionally, however, a temporary conductivity caused by condensation must be expected.

Pollution Degree III: Conductive pollution occurs, or dry, non-conductive pollution occurs, which becomes conductive due to condensation, which is expected.

Pollution Degree IV: Persistent conductive pollution occurs, for example, the pollution caused by conductive dust, rain or snow.

13.4 Meaning of Battery SN Code

*****2388*****



The 11th-14th digits

Bits 11-14 of the product SN code are the production time code.

The above picture has a production date of 2023-08-08.

- The 11th and 12th digits are the last two digits of the year of production, e.g., 2023 is represented by 23;
- The 13th digit is the month of production, e.g. August is denoted by 8;

The details are as follows:

Month	January~September	October	November	December
Month Code	1~9	A	B	C

- The 14th digit is the date of manufacture, e.g., 8th indicated by 8;

Priority is given to the use of numbers, e.g. 1~9 for days 1~9, A for day 10 and so on. The letters I and O are not used to avoid confusion. The details are as follows:

Production Date	1st	2nd	3rd	4th	5th	6th	7th	8th	9th
Code	1	2	3	4	5	6	7	8	9

Production Date	10th	11th	12th	13th	14th	15th	16th	17th	18th	19th	20th
Code	A	B	C	D	E	F	G	H	J	K	L

Production Date	21st	22nd	23rd	24th	25th	26th	27th	28th	29th	30th	31st
Code	M	N	P	Q	R	S	T	U	V	W	X



Official Website

GoodWe Technologies Co., Ltd.

 No. 90 Zijin Rd., New District, Suzhou, 215011, China

 www.goodwe.com

 service@goodwe.com



Local Contacts