



## User Manual

### Hybrid Inverter EH Series/EH Plus Series 3.6-6kW



**Copyright © GoodWe Technologies Co.,Ltd. 2022. All rights reserved.**

No part of this manual can be reproduced or transmitted to the public platform in any form or by any means without the prior written authorization of GoodWe Technologies Co.,Ltd.

**Trademarks**

**GOODWE** and other GOODWE trademarks are trademarks of GoodWe Technologies Co.,Ltd. All other trademarks or registered trademarks mentioned in this manual are owned by GoodWe Technologies Co.,Ltd.

**Notice**

The information in this user manual is subject to change due to product updates or other reasons. This guide cannot replace the product labels or the safety precautions in the user manual unless otherwise specified. All descriptions here are for guidance only.

# CONTENT

<b>1</b>	<b>About This Manual</b>	<b>1</b>
1.1	Applicable Model	1
1.2	Target Audience	1
1.3	Symbol Definition	2
1.4	Updates	2
<b>2</b>	<b>Safety Precaution</b>	<b>3</b>
2.1	General Safety	3
2.2	PV String Safety	3
2.3	Inverter Safety	4
2.4	Battery Safety	5
2.5	Personal Requirements	5
2.6	EU Declaration of Conformity	5
<b>3</b>	<b>Product Introduction</b>	<b>6</b>
3.1	Product Introduction	6
3.2	Application Scenarios	7
3.3	Working Mode	9
3.3.1	System Working Mode	9
3.3.3	Inverter Operation Mode	12
3.4	Features	13
3.5	Appearance	14
3.5.1	Parts	14
3.5.2	Dimension	14
3.5.3	Indicators	15
3.5.4	Nameplate	16
<b>4</b>	<b>Check and Storage</b>	<b>17</b>
4.1	Check Before Receiving	17
4.2	Deliverables	17
4.3	Storage	18
<b>5</b>	<b>Installation</b>	<b>19</b>
5.1	Installation Requirements	19
5.2	Inverter Installation	22
5.2.1	Moving the Inverter	22
5.2.2	Installing the Inverter	22
<b>6</b>	<b>Electrical Connection</b>	<b>24</b>
6.1	System Wiring Diagram	24
6.2	Safety Precautions	26
6.3	Connecting the PE Cable	26

6.4	Connecting the DC Input Cable (PV)	27
6.5	Connecting the Battery Cable	30
6.6	Connecting the AC Cable	33
6.6.1	Connecting the AC Cable (ON-GRID)	34
6.6.2	Connecting the AC Cable (BACK-UP)	34
6.7	Communication Connection	36
6.7.1	Connecting the Communication Cable	36
6.7.2	Connecting BMS or Meter Communication Cable (Optional)	37
6.7.3	Installing the Communication Module (Optional)	39
<b>7</b>	<b>Equipment Commissioning</b>	<b>40</b>
7.1	Check Before Power ON	40
7.2	Power On	40
<b>8</b>	<b>System Commissioning</b>	<b>41</b>
8.1	Indicators and Buttons	41
8.2	Setting Inverter Parameters via PV Master App	42
8.3	Monitoring via SEMS Portal	42
<b>9</b>	<b>Maintenance</b>	<b>43</b>
9.1	Power OFF the Inverter	43
9.2	Removing the Inverter	43
9.3	Disposing of the Inverter	43
9.4	Troubleshooting	44
9.5	Routine Maintenance	51
<b>10</b>	<b>Technical Parameters</b>	<b>52</b>

# 1 About This Manual

This manual describes the product information, installation, electrical connection, commissioning, troubleshooting, and maintenance. Read through this manual before installing and operating the product. All the installers and users have to be familiar with the product features, functions, and safety precautions. This manual is subject to update without notice. For more product details and latest documents, visit <https://en.goodwe.com>.

## 1.1 Applicable Model

This manual applies to the listed inverters below:



Model	Nominal Output Power	Nominal Output Voltage
GW3600-EH	3600W	230/220V
GW5000-EH	5000W	
GW6000-EH	6000W	
GW3600N-EH	3600W	
GW5000N-EH	5000W	
GW6000N-EH	6000W	

## 1.2 Target Audience

This manual applies to trained and knowledgeable technical professionals. The technical personnel has to be familiar with the product, local standards, and electric systems.

## 1.3 Symbol Definition

Different levels of warning messages in this manual are defined as follows:

 <b>DANGER</b>
Indicates a high-level hazard that, if not avoided, will result in death or serious injury.
 <b>WARNING</b>
Indicates a medium-level hazard that, if not avoided, could result in death or serious injury.
 <b>CAUTION</b>
Indicates a low-level hazard that, if not avoided, could result in minor or moderate injury.
<b>NOTICE</b>
Highlights and supplements the texts. Or some skills and methods to solve product-related problems to save time.

## 1.4 Updates

The latest document contains all the updates made in earlier issues.

### V1.4 2022-08-30

- Updated Technical Parameters

## 2 Safety Precaution

Please strictly follow these safety instructions in the user manual during the operation.

### NOTICE

The inverters are designed and tested strictly in compliance with related safety rules. Read and follow all the safety instructions and cautions before any operations. Improper operation might cause personal injury or property damage as the inverters are electrical equipment.

### 2.1 General Safety

#### NOTICE

- The information in this user manual is subject to change due to product updates or other reasons. This guide cannot replace the product warning labels unless otherwise specified. All descriptions here are for guidance only.
- Before installations, read through the user manual to learn about the product and the precautions.
- All operations should be performed by trained and knowledgeable technicians who are familiar with local standards and safety regulations.
- Use insulating tools and wear personal protective equipment when operating the equipment to ensure personal safety. Wear anti-static gloves, clothes, and wrist strips when touching electron devices to protect the inverter from damage.
- Strictly follow the installation, operation, and configuration instructions in this manual. The manufacturer shall not be liable for equipment damage or personal injury if you do not follow the instructions. For more warranty details, please visit <https://en.goodwe.com/warranty>.

### 2.2 PV String Safety

#### DANGER

Connect the DC cables of the inverter to the delivered DC terminals. Severe damage might happen if other types of DC terminals are used, which are beyond the manufacturer's liability.

#### WARNING

- Ensure the component frames and the bracket system are securely grounded.
- Ensure the DC cables are connected tightly, securely and correctly.
- Measure the DC cables with a multimeter to avoid reverse polarity connection. Also, the voltage should be under the permissible range.
- Do not connect one PV string to more than one inverter at the same time. Otherwise, it may cause damage to the inverter.









### 2.3 Inverter Safety

**WARNING**

- The voltage and frequency at the connection point meet the inverter grid connection requirements.
- Additional protective devices like circuit breakers or fuses are recommended on the AC side. Specification of the protective device should be at least 1.25 times the maximum AC output current.
- Make sure that all the groundings are tightly connected. When there are multiple inverters, make sure that all the grounding points on the enclosures are equipotential bonding.
- BACK-UP is not recommended if the PV system is not configured with batteries. Otherwise, the risk in system power usage is beyond the equipment manufacturer's warranty scope.
- Testing to AS/NZS 4777.2:2020 to multiple inverter combinations has not been conducted.

**DANGER**

- All labels and warning marks should be visible after the installation. Do not cover, scrawl, or damage any label on the equipment.
- Warning labels on the inverter are as follows:

	DANGER High voltage hazard. Disconnect all incoming power and turn off the product before working on it.		Delayed discharge. Wait 5 minutes after power off until the components are completely discharged.
	Read through the user manual before any operations.		Potential risks exist. Wear proper PPE before any operations.
	High-temperature hazard. Do not touch the product under operation to avoid being burnt.		Grounding point.
	CE certification mark		Do not dispose of the inverter as household waste. Discard the product in compliance with local laws and regulations, or send it back to the manufacturer.



## 2.4 Battery Safety

### WARNING

- The battery used with the inverter shall be approved by the inverter manufacturer. The approved battery list can be obtained through the official website.
- Before installations, read through the corresponding battery's User Manual to learn about the product and the precautions. Strictly follow its requirements.
- If the battery discharged completely, please charge it in strict accordance with the corresponding user manual.
- Factors such as: temperature, humidity, weather conditions, etc. may limit the battery's current and affect its load.
- Contact after-sale service immediately if the battery is not able to be started. Otherwise, the battery might be damaged permanently.
- Use the multimeter to measure the DC cable to avoid reverse polarity connection. Also, the voltage should be under the permissible range.
- Do not connect one battery group to several inverters at the same time. Otherwise, it may cause damage to the inverter.

## 2.5 Personal Requirements

### NOTICE

- Personnel who install or maintain the equipment must be strictly trained, learn about safety precautions and correct operations.
- Only qualified professionals or trained personnel are allowed to install, operate, maintain, and replace the equipment or parts.

## 2.6 EU Declaration of Conformity

GoodWe Technologies Co., Ltd. hereby declares that the inverter with wireless communication modules sold in the European market meets the requirements of the following directives:

- Radio Equipment Directive 2014/53/EU (RED)
- Restrictions of Hazardous Substances Directive 2011/65/EU and (EU) 2015/863 (RoHS)
- Waste Electrical and Electronic Equipment 2012/19/EU
- Registration, Evaluation, Authorization and Restriction of Chemicals (EC) No 1907/2006 (REACH)

GoodWe Technologies Co., Ltd. hereby declares that the inverter without wireless communication modules sold in the European market meets the requirements of the following directives:

- Electromagnetic compatibility Directive 2014/30/EU (EMC)
- Electrical Apparatus Low Voltage Directive 2014/35/EU (LVD)
- Restrictions of Hazardous Substances Directive 2011/65/EU and (EU) 2015/863 (RoHS)
- Waste Electrical and Electronic Equipment 2012/19/EU
- Registration, Evaluation, Authorization and Restriction of Chemicals (EC) No 1907/2006 (REACH)

You can download the EU Declaration of Conformity on <https://en.goodwe.com>  
 Densys pv5 | We deliver. You install. The sun does all the rest. | Data sheet provided for you @ [www.densys-pv5.de](http://www.densys-pv5.de)

### 3 Product Introduction

#### 3.1 Product Introduction

##### Intended usage

Inverters control and optimize the power in PV systems through an integrated energy management system. The power generated in the PV system can be used, stored in the battery, output to the utility grid, etc.

##### Model

This manual applies to the listed inverters below:

- GW3600-EH
- GW5000-EH
- GW6000-EH
- GW3600N-EH
- GW5000N-EH
- GW6000N-EH

##### Model description

#### GW3000N-EH



No.	Referring to	Explanation
1	Brand Code	GW: GoodWe
2	Rated Power	3000: the rated power is 3000W.
3	Product Feature	N: higher PV input current
4	Series Code	EH: single-phase hybrid inverter

##### Supported Grid Types

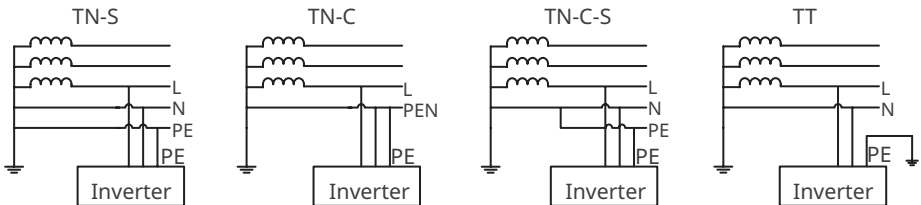

## 3.2 Application Scenarios

### WARNING

- The PV system is not suitable to connect equipment that relies on a stable power supply, such as medical equipment to sustain life. Ensure that no personal injury is occurred when the system is disconnected.
- Avoid loads with high starting current like high-power water pumps in the PV system. Otherwise, the off-grid output may fail due to excessive instantaneous power.
- BACK-UP is not recommended if the PV system is not configured with batteries. Otherwise, the risk in system power usage is beyond the equipment manufacturer's warranty scope.
- Factors such as: temperature, humidity, weather conditions, etc. may limit the battery's current and affect its load.
- The inverter offers UPS function. Under normal circumstances, the back up switching time is less than 10 ms.
- When single overload protection occurs, the inverter can restart automatically; however, the restarting time will be extended if it happens several times. For a faster restarting, try it via APP .
- When the grid is disconnected, the off-grid function of the inverter will be closed automatically if the load capacity exceeds the inverter's rated power; to enable it, turn off the large loads and ensure the load power is less than the rated power of the inverter.
- Normal household loads can be supported when the inverter is in back-up mode. Accepted loads as below:
  - Inductive loads: 1.5P non-inverter air conditioner can be connected to the inverter. If two or more non-inverter air conditioners are connected, the UPS may be unstable.
  - Capacitive load: total power  $\leq 0.6$  times of the inverter's rated output power.

### Self consumption mode

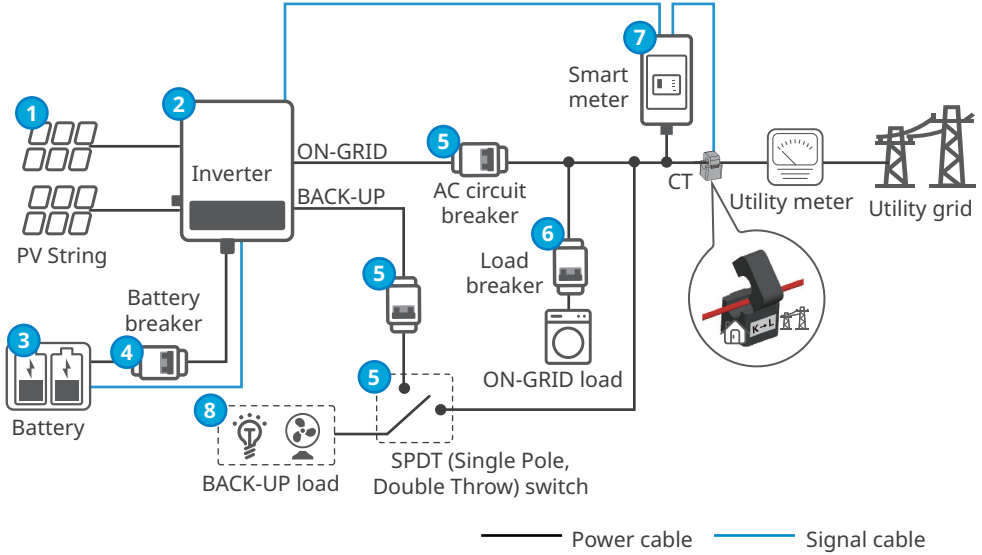

No.	Parts	Description
1	PV String	The PV string consists of PV modules.
2	Inverter	Support EH series and EH Plus series inverters.
3	Battery	Select the battery model according to the inverter model and the approved battery list.
4	Battery breaker	Recommended specifications: nominal current $\geq$ 40A, nominal voltage $\geq$ 600V.
5	AC circuit breaker	Recommended AC circuit breaker specifications: <ul style="list-style-type: none"> <li>GW3600N-EH, GW5000-EH, GW5000N-EH: nominal current<math>\geq</math>50A, nominal voltage<math>\geq</math>230V.</li> <li>GW6000-EH, GW6000N-EH: nominal current<math>\geq</math>63A, nominal voltage<math>\geq</math>230V.</li> </ul>
6	Load breaker	Depend on the actual using load.
7	Smart meter	Purchase the smart meter from the inverter manufacturer. Recommended model: GM1000.
8	BACK-UP loads	Connecting BACK-UP loads, such as loads requiring 24-hour power supply or other important loads.

## 3.3 Working Mode

### 3.3.1 System Working Mode

#### Economic mode

#### NOTICE

- Select Economic mode only when it meets the local laws and regulations, e.g., whether the grid is allowed to charge the battery. If not, do not use this mode.
  - It is recommended to use economic mode in scenarios when the peak-valley electricity price varies a lot.
- Daytime: when the electricity price is at its peak, the battery will power the load first, and the remaining power can be sold to the grid.
  - Night: when the electricity price is at its valley, set the time for the grid to charge the battery.

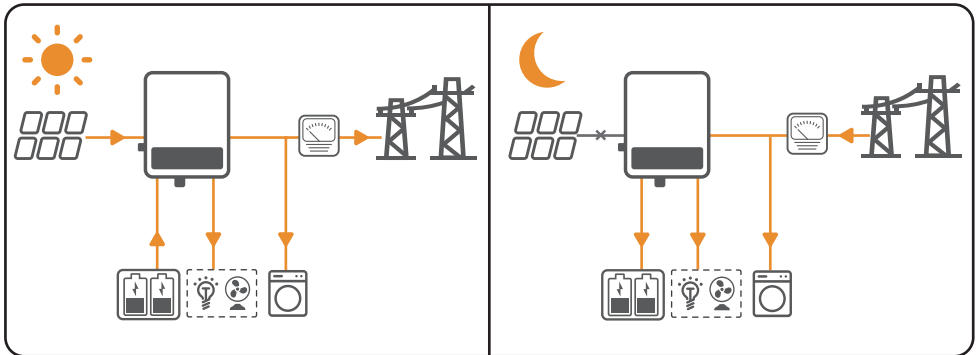

### Self consumption mode

#### NOTICE

- For solar power, consider self consumption mode in priority: the excess power charges the battery in day time; the battery supplies power to the load when there is no solar power generated at night. This will improve the self consumption rate and saves electricity costs.
- It is suitable for areas with high electricity prices and little or no solar power generation subsidies.

- Day:
  - When the power generated in the PV system is sufficient, it will supply the loads in priority. And the excess power will charge the batteries first. The remaining power will be sold to the grid.
  - When the power generated in the PV system is insufficient or no power is generated, the battery will supply the loads in priority. If the battery power is insufficient, then the load will be powered by the grid.
- Night:
 

If the battery power is sufficient, the load will be powered by the battery. If the battery power is not enough, the load will be powered by the grid.

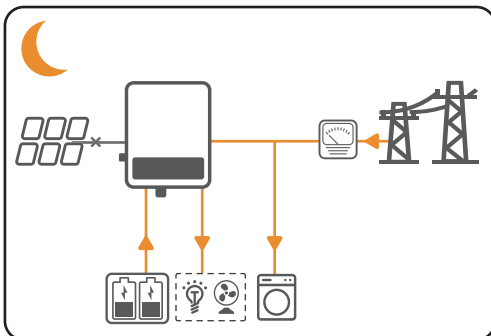
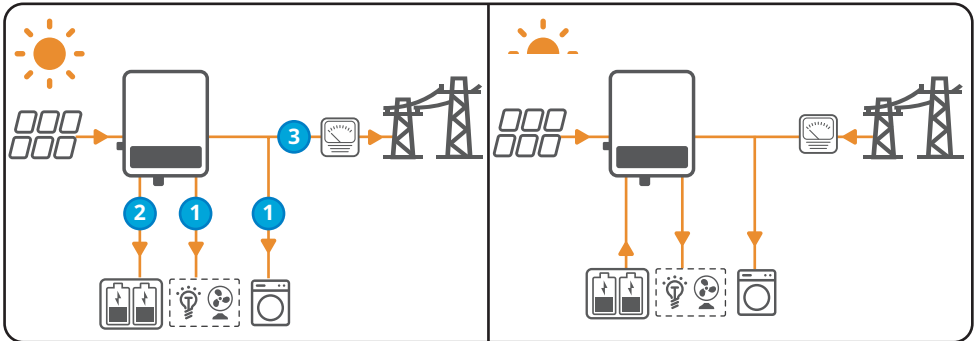

## Back-up mode

### NOTICE

- The back-up mode is mainly applied to the scenario where the grid is unstable and there is an important load. When the grid is disconnected, the inverter turns to off-grid mode to supply power to the load; when the grid is restored, the inverter switches to on-grid mode.
- The battery stops discharging when it reaches SOC. When there is sunlight the next day, the battery starts to supply power to the load after it is charged to a certain power level.
- When the power generated in the PV system is sufficient, the power generated in the PV system will charge the battery in priority. And the excess power will charge the load. The remaining power will be sold to the grid.
- When there is no power generated in the PV system:
  - The grid will supply the load when it is normal. (Do not select this mode if the grid is not allowed to charge the battery according to the local laws and regulations.)
  - The inverter will enter off-grid mode and the battery will supply power to the load when the grid is abnormal.

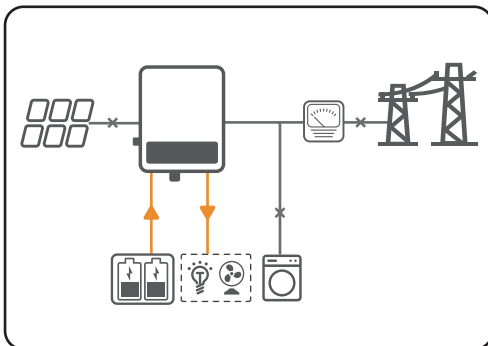
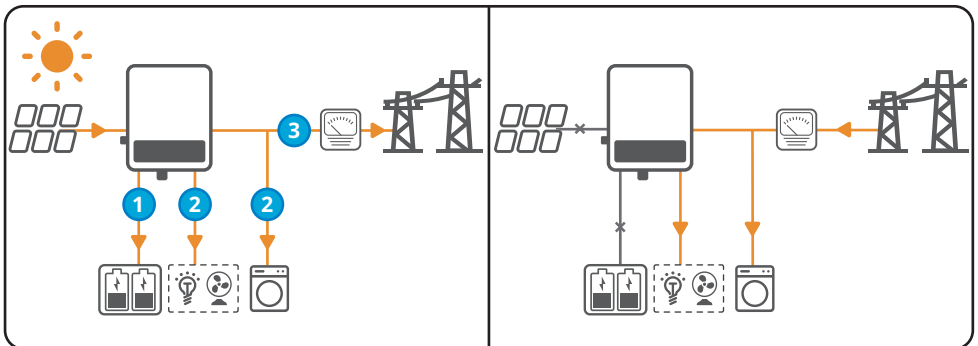

### 3.3.3 Inverter Operation Mode

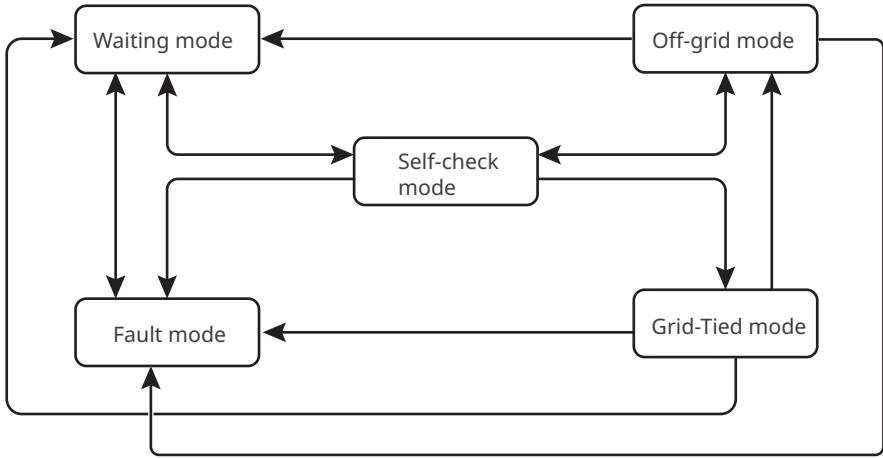

No.	Parts	Description
1	Waiting mode	Waiting stage after the inverter is powered on. <ul style="list-style-type: none"> <li>When the conditions are met, it enters the self-check mode.</li> <li>If there is a fault, the inverter enters the fault mode.</li> </ul>
2	Self-check mode	Before the inverter starts up, it continuously performs self-check, initialization, etc. <ul style="list-style-type: none"> <li>When the conditions are met, it enters the grid-tied mode, and the inverter starts on grid connection.</li> <li>If the grid is not detected, it enters the off-grid mode and the inverter runs off-grid; if the inverter has no off-grid function, it enters the wait mode.</li> <li>If the self-check is not passed, it enters the fault mode.</li> </ul>
3	Grid-Tied mode	The inverter is grid-tied successfully. <ul style="list-style-type: none"> <li>If the grid is not detected, it enters the off-grid mode.</li> <li>If a fault is detected, it enters the fault mode.</li> <li>If the conditions do not meet grid-tied requirements and the off-grid output function is not turned on, it enters the wait mode.</li> </ul>
4	Off-grid mode	When the grid is powered off, the inverter switches to the off-grid mode and continues to supply power to the load via BACK-UP port. <ul style="list-style-type: none"> <li>If a fault is detected, it enters the fault mode.</li> <li>If the conditions do not meet grid-tied requirements and the off-grid output function is not turned on, it enters the wait mode.</li> <li>If the conditions meet grid-tied requirements and the off-grid output function is turned on, it enters the self-check mode.</li> </ul>
5	Fault mode	If a fault is detected, the inverter enters the fault mode. When the fault is cleared, it enters the wait mode.





## 3.4 Features

### Power Derating

For a safe operation, the inverter will automatically reduce the output power when the operating environment is not ideal.

The following are the factors that may occur power derating. Please try to avoid them when the inverter is working.

- Unfavorable environmental conditions, e.g., direct sunlight, high temperature, etc.
- Inverter's output power percentage has been set.
- Over-frequency derating.
- Higher input voltage value.
- Higher input current value.

### Earth Fault Alarm

Reserved port for earth fault alarm.

Once an earth fault occurs, the LED indicator will light up. And the system will email the fault information to the customer. Install the inverter in a high traffic area where the indicators would be noticed.

## 3.5 Appearance

### 3.5.1 Parts

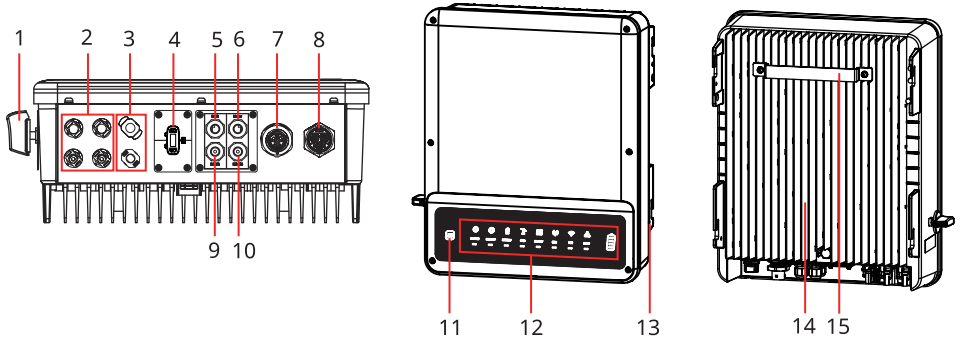







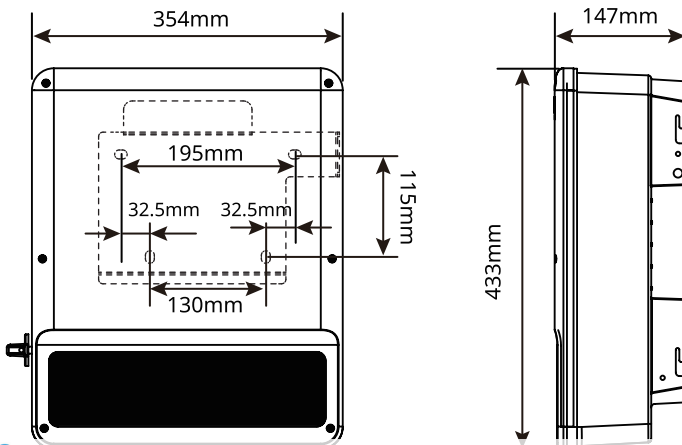





















- |  |                                |                                     |
|--|--------------------------------|-------------------------------------|
| 1. DC switch <sup>[1]</sup>                | 2. PV input terminal (PV1/PV2) | 3. Battery input terminal (BAT +/-) |
| 4. Communication module port (WiFi or LAN) | 5. BMS communication port      | 6. Meter communication port         |
| 7. Back-Up port                            | 8. On-Grid port                | 9. DRED communication port          |
| 10. RS485 communication port               | 11. Wi-Fi reset                | 12. Indicators                      |
| 13. PE terminal                            | 14. Heat sink                  | 15. Mounting Plate                  |

If the inverter is not equipped with a DC switch, an external DC breaker shall be added. The external DC breaker shall be AU/NZ certified; Complied to AS60947.3:2018; Be classified as DC-PV 2; With ratings and properties suitable for the intended application conditions such as outdoor, exposed to sunshine, on non-combustible material surface.

### 3.5.2 Dimension



### 3.5.3 Indicators

Indicators	Status	Description
SYSTEM		ON = The system is ready.
		BLINK = The system is starting.
		OFF =The system is not working.
BACK-UP		ON = Back-up is ready / power available.
		OFF = Back-up is off / power not available.
BATTERY		ON = The battery is charging.
		BLINK 1 = The battery is discharging.
		BLINK 2 = The battery is low / soc is low.
		OFF = The battery is disconnected / not active.
GRID		ON = The grid is active and connected.
		BLINK = The grid is active but not connected.
		OFF = The grid is not active.
ENERGY		ON = Consuming energy from grid / buying.
		BLINK 1 = Supplying energy to grid / zeroing.
		BLINK 2 = Supplying energy to grid / selling.
		OFF = The grid is not connected or the system is not working.
COM		ON = Both BMS communication and meter communication are ok.
		BLINK 1 = BMS communication fails; meter communication is ok.
		BLINK 2 = BMS communication is ok; meter communication fails.
		OFF = BMS communication and meter communication fail.
WiFi		ON = WiFi connected / active.
		BLINK 1 = WiFi is resetting.
		BLINK 2 = WiFi is not connected to the router.
		BLINK 4 = WiFi server problem.
		OFF = WiFi is not active.
FAULT		ON = A fault has occurred.
		BLINK 1 = Back-up output overload / reduce load.
		OFF = No fault.

### 3.5.4 Nameplate

The nameplate is for reference only.

<b>GOODWE</b>		GW trademark, product type, and product model
Product: Hybrid Inverter Model: ***		
PV Input	UDC max: ***Vd.c.	Technical parameters
	UMPP: ***Vd.c.	
	Idc,max: ***Ad.c.	
	ISC PV: ***Ad.c.	
Battery	Ubatt: ***Vd.c., Li-Ion	
	Ibatt,max(C/D): ***Ad.c	
On-grid	UAC: ***Va.c.	
	fAC: ***Hz	
	PAC: ***kW	
	IAC,max(to grid): ***Aa.c.	
	Sr(to grid): ***kVA	
	Smax(to grid): ***kVA	
	IAC(from grid): ***Aa.c.	
Back-up	Sr(from grid): ***kVA	
	Smax(from grid): ***kVA	
	UAC,r: ***Va.c.	
	fAC,r: ***Hz	
	IAC,max: ***Aa.c.	
S: ***kVA		
Smax: ***kVA		
P.F.: -1,0.8cap...0.8ind, TOperating: -35~60°C Non-isolated, IP66, Protective Class I, OVC DCII/ACIII		
		Safety symbols and certification marks
S/N:		Contact information and serial number
Good We Technologies Co., Ltd. E-mail: service@goodwe.com No.90 Ziji n Rd., New District, Suzhou, 215011, China S/N		

## 4 Check and Storage

### 4.1 Check Before Receiving

Check the following items before receiving the product.

1. Check the outer packing box for damage, such as holes, cracks, deformation, and other signs of equipment damage. Do not unpack the contents from the box and contact the supplier as soon as possible if any damage is found.
2. Check the inverter model. If the inverter model is not what you requested, do not unpack the product and contact the supplier.
3. Check the deliverables for correct model, complete contents, and intact appearance. Contact the supplier as soon as possible if any damage is found.

### 4.2 Deliverables

#### WARNING

Connect the DC cables with the included terminals. The manufacturer shall not be liable for the damage if other terminals are used.

#### NOTICE

- The number of expansion bolts, PV connectors, and battery connectors are various depending on different inverters. The actual accessories may differ.
- The smart meter will not be included for Battery-Ready models. Contact the manufacturer or dealer to purchase the smart meter if you need.

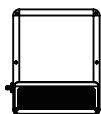

Inverter x 1

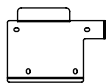

Mounting plate x 1



Expansion bolts x N

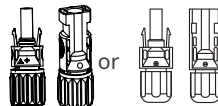

PV connectors x N



ON-GRID AC connector x 1



BACK-UP AC connector x 1



Smart meter x 1\*

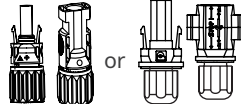

Battery connectors x N



Communication module x 1



Documents x 1



PE terminal x 1

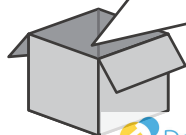

### 4.3 Storage

If the equipment is not to be installed or used immediately, please ensure that the storage environment meets the following requirements:

1. Do not unpack the outer package or throw the desiccant away.
2. Store the equipment in a clean place. Make sure the temperature and humidity are appropriate and no condensation.
3. The height and direction of the stacking inverters should follow the instructions on the packing box.
4. The inverters must be stacked with caution to prevent them from falling.
5. If the inverter has been long term stored, it should be checked by professionals before being put into use.

## 5 Installation

### 5.1 Installation Requirements

#### Installation Environment Requirements

1. Do not install the equipment in a place near flammable, explosive, or corrosive materials.
2. Do not install the equipment in a place that is easy to touch, especially within children's reach. High temperature exists when the equipment is working. Do not touch the surface to avoid burning.
3. Avoid the water pipes and cables buried in the wall when drilling holes.
4. Install the equipment in a sheltered place to avoid direct sunlight, rain, and snow. Build a sunshade if it is needed.
5. Install the equipment in a well-ventilated place to ensure good dissipation. Also, the installation space should be large enough for operations.
6. The equipment with a high ingress protection rating can be installed indoors or outdoors. The temperature and humidity at the installation site should be within the appropriate range.
7. Install the equipment at a height that is convenient for operation and maintenance, electrical connections, and checking indicators and labels.
8. The inverter shall be installed below the maximum operating elevation of 3000m.
9. Install the equipment away from high magnetic fields to avoid electromagnetic interference. If there is any radio or wireless communication equipment below 30MHz near the equipment, you have to:
  - Add a multi-turn winding ferrite core at the DC input line or AC output line of the inverter, or add a low-pass EMI filter.
  - Install the inverter at least 30m far away from the wireless equipment.

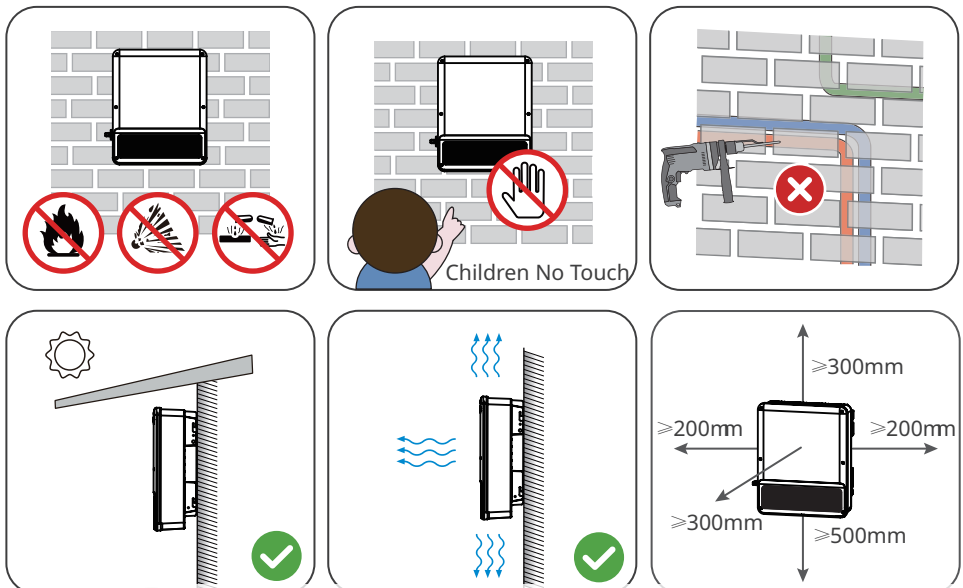

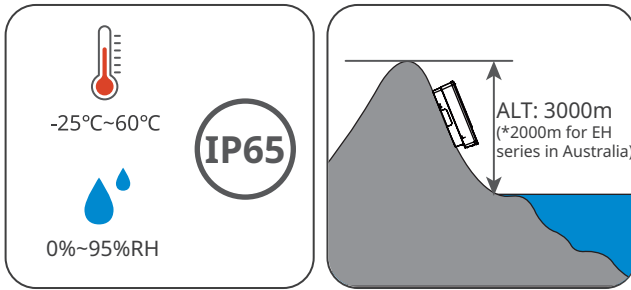

### Mounting Support Requirements

- The mounting support shall be nonflammable and fireproof.
- Install the equipment on a surface that is solid enough to bear the inverter weight.
- Do not install the product on the support with poor sound insulation to avoid the noise generated by the working product, which may annoy the residents nearby.

### Installation Angle Requirements

- Install the inverter vertically or at a maximum back tilt of 15 degrees.
- Do not install the inverter upside down, forward tilt, back forward tilt, or horizontally.

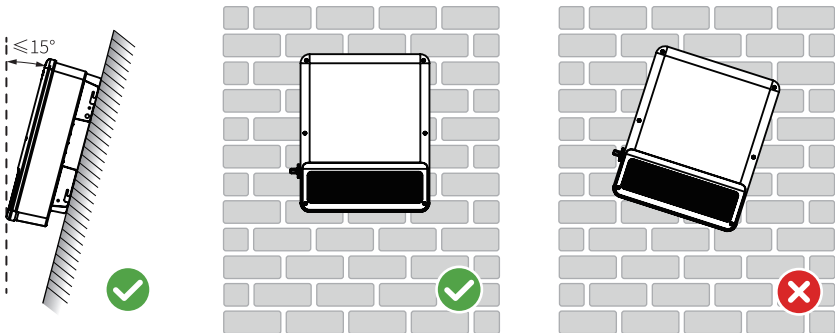



## Installation Tool Requirements

The following tools are recommended when installing the equipment. Use other auxiliary tools on site if necessary.

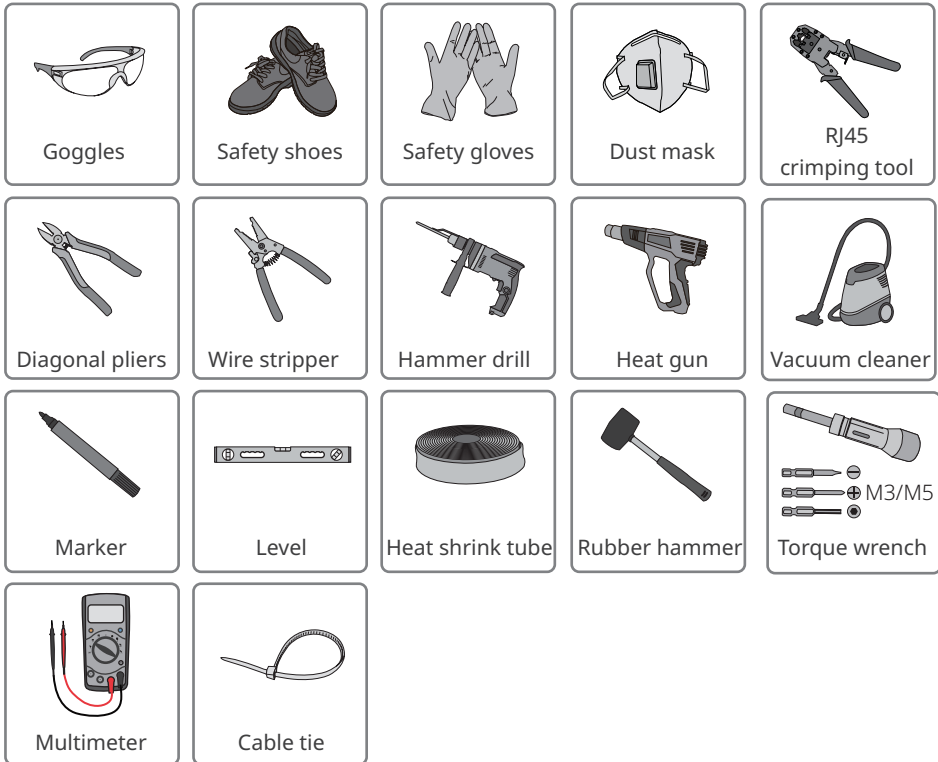

## 5.2 Inverter Installation

### 5.2.1 Moving the Inverter

#### CAUTION

- Operations such as transportation, shipment, installation and so on shall in compliance with the laws and regulations of the country or region where the inverter is located.
- Move the inverter to the site before installation. Follow the instructions below to avoid personal injury or equipment damage.
  1. Consider the weight of the equipment before moving it. Assign enough personnel to move the equipment to avoid personal injury.
  2. Wear safety gloves to avoid personal injury.
  3. Keep balance to avoid falling down when moving the equipment.

### 5.2.2 Installing the Inverter

#### NOTICE

- Avoid the water pipes and cables buried in the wall when drilling holes.
- Wear goggles and a dust mask to prevent the dust from being inhaled or contacting eyes when drilling holes.
- Make sure the inverter is firmly installed in case of falling down.
- The DC switch lock is prepared by the customer.

**Step 1:** Put the plate on the wall horizontally and mark positions for drilling holes.

**Step 2:** Drill holes to a depth of 80mm using the hammer drill. The diameter of the drill bit should be 10mm.

**Step 3:** Use the expansion bolts to fix the inverter on the wall.

**Step 4: (Optional)** Secure the DC switch with the DC switch lock, ensuring that the DC switch is "OFF" during installation.

**Step 5:** Install the inverter on the mounting plate.

**Step 6:** Tighten the nuts to secure the mounting plate and the inverter.

**Step 7:** Install the anti-theft lock.

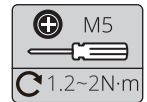
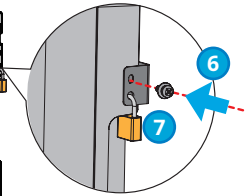
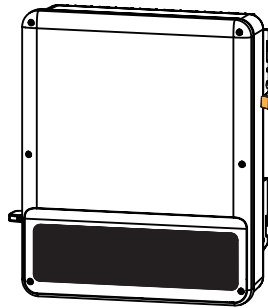
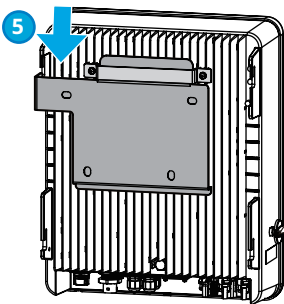
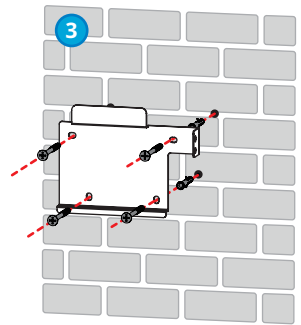
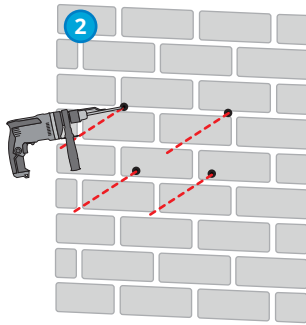
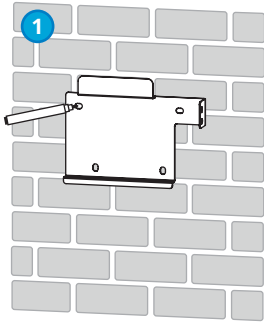

## 6 Electrical Connection

### 6.1 System Wiring Diagram

#### NOTICE

- N and PE wiring via ON-GRID and BACK-UP ports of the inverter are different based on the regulation requirements of different regions. Refer to the specific requirements of local regulations.
- There are integrated relays inside of the inverter's ON-GRID and BACK-UP AC ports. When the inverter is in the off-grid mode, the ON-GRID relay is disconnected; while when the inverter is in grid-tied mode, it is connected.
- When the inverter is powered on, the BACK-UP AC port is live. Power off the inverter first if maintenance is required for the loads connected to BACK-UP ports. Otherwise, it may cause electric shock.

**N and PE cables are connected together in the Main Panel for wiring.**

#### NOTICE

The following diagram is applicable to areas in Australia, New Zealand, South Africa, etc.

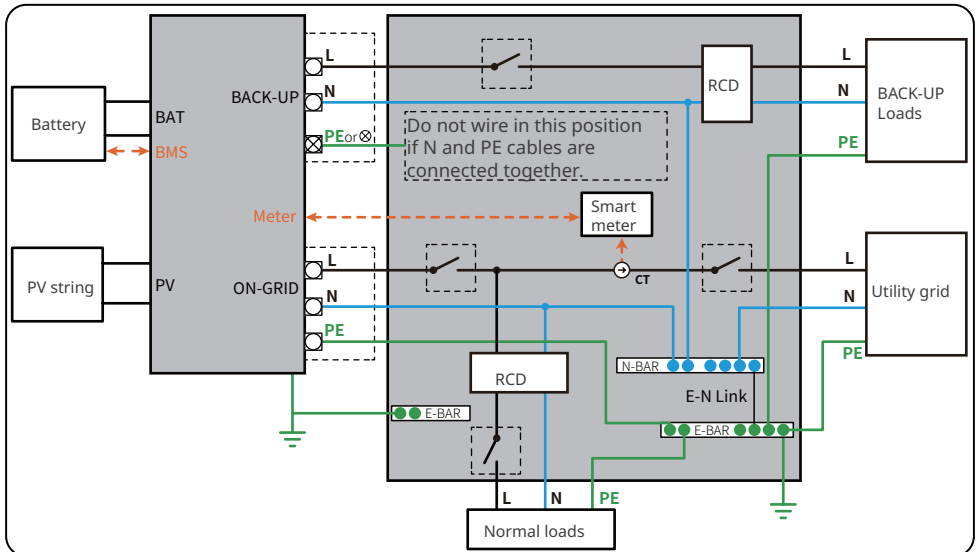

**N and PE cables are separately wired in the Main Panel.**

**NOTICE**

The following diagram is applicable to areas except Australia, New Zealand, South Africa.

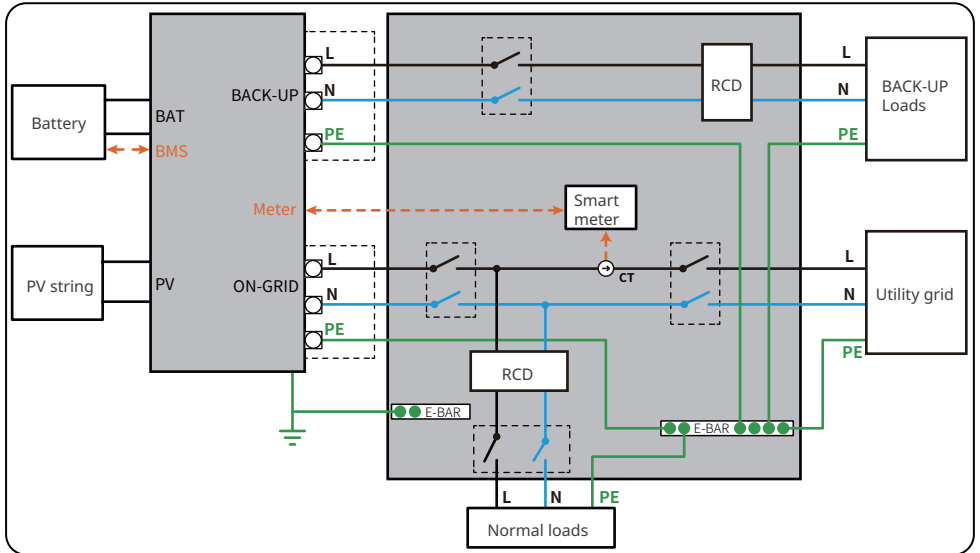

## 6.2 Safety Precautions

### DANGER

- Perform electrical connections in compliance with local laws and regulations. Including operations, cables, and component specifications.
- Disconnect the DC switch and the AC output switch of the inverter to power off the inverter before any electrical connections. Do not work with power on. Otherwise, an electric shock may occur.
- Tie the cables of the same type together, and place cables of different types apart. Do not place the cables entangled or crossed.
- If there is too much tension on a wire, it may be poorly connected. Reserve the appropriate length of wire before connection.
- Make sure that the cable conductor is in full contact with the terminal and the cable insulation part is not crimped with the terminal when crimping the terminal. Otherwise, the inverter may not be able to work properly, or the connection may be unreliable during working, which may cause terminal block damage, etc.

### NOTICE

- Wear personal protective equipment like safety shoes, safety gloves, and insulating gloves during electrical connections.
- All electrical connections should be performed by qualified professionals.
- Cable colors in this document are for reference only. The cable specifications shall meet local laws and regulations.

## 6.3 Connecting the PE Cable

### WARNING

- The PE cable connected to the enclosure of the inverter cannot replace the PE cable connected to the AC output port. Make sure that both of the two PE cables are securely connected.
- Make sure that all the grounding points on the enclosures are equipotential connected when there are multiple inverters.
- To improve the corrosion resistance of the terminal, you are recommended to apply silica gel or paint on the ground terminal after installing the PE cable.
- The PE cable should be prepared by the customer. Recommended specifications:
  - Type: single-core outdoor copper cable
  - Conductor cross-sectional area: 4mm<sup>2</sup>

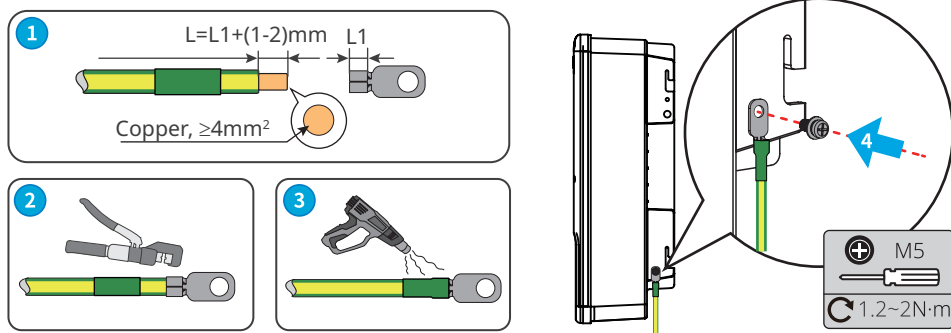

### 6.4 Connecting the DC Input Cable (PV)

 **DANGER**

- Do not connect one PV string to more than one inverter at the same time. Otherwise, it may cause damage to the inverter.
- Confirm the following information before connecting the PV string to the inverter. Otherwise, the inverter may be damaged permanently or even cause fire and cause personal and property losses.
  1. Make sure that the max short circuit current and the max input voltage per MPPT are within the permissible range.
  2. Make sure that the positive pole of the PV string connects to the PV+ of the inverter. And the negative pole of the PV string connects to the PV- of the inverter.

 **WARNING**

The PV strings cannot be grounded. Ensure the minimum insulation resistance of the PV string to the ground meets the minimum insulation resistance requirements before connecting the PV string to the inverter ( $R = \text{maximum input voltage} / 30\text{mA}$ ).

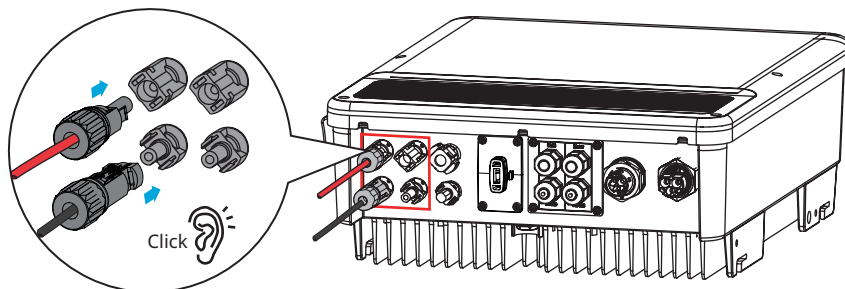

## Vaconn

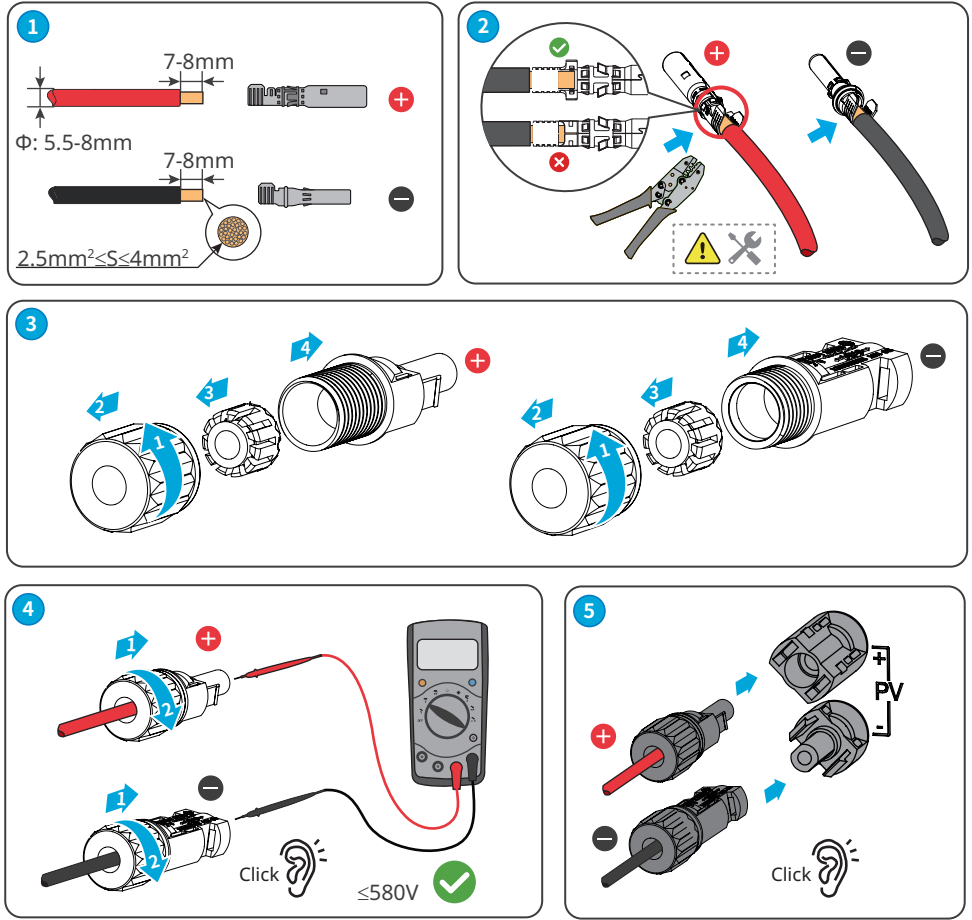



## MC4

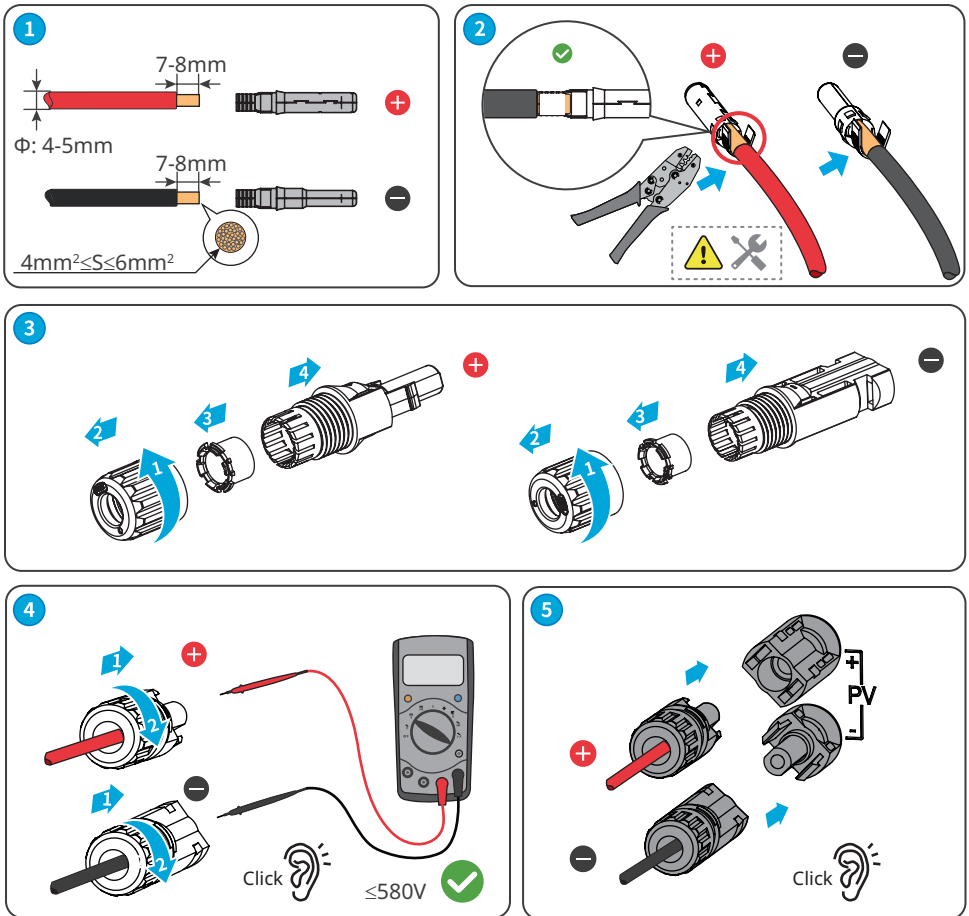

## 6.5 Connecting the Battery Cable

### NOTICE

- For Battery-Ready inverters, please contact the manufacturer or dealer to activate the battery related functions first if you need them. Do not connect any battery to the inverter if the battery related functions are not activated. Otherwise the inverter will stop working.
- Ensure that the battery ports are sealed properly if there is no battery connected.

### DANGER

- The battery used with the inverter shall be approved by the inverter manufacturer. The approved battery list can be obtained through the official website.
- A short circuit in the battery may cause personal injury. The instantaneous high current caused by a short circuit can release a large amount of energy and may cause a fire.
- Before connecting the battery cable, ensure the inverter and the battery, and downstream&upstream switches, are all disconnected.
- It is forbidden to connect and disconnect the battery cables when the inverter is running. Otherwise it may cause electric shock.
- Do not connect one battery pack to more than one inverter at the same time. Otherwise, it may cause damage to the inverter.
- It is forbidden to connect loads between the inverter and batteries.
- When connecting battery cables, use insulated tools to prevent accidental electric shock or short circuit to the batteries.
- Ensure that the open circuit voltage of the battery is within the permissible range of the inverter.

### WARNING

- Connect the battery cables to the corresponding terminals such BAT+, BAT- and grounding ports correctly. Otherwise it will cause damage to the inverter.
- Ensure that the whole cable cores are inserted into the terminal holes. No part of the cable core can be exposed.
- Ensure that the cables are connected securely. Otherwise it will cause damage to the inverter due to overheat during its operation.
- An external DC circuit breaker is recommended if there is no integrated DC circuit breaker inside the battery. Recommended specifications: 40A/600V.

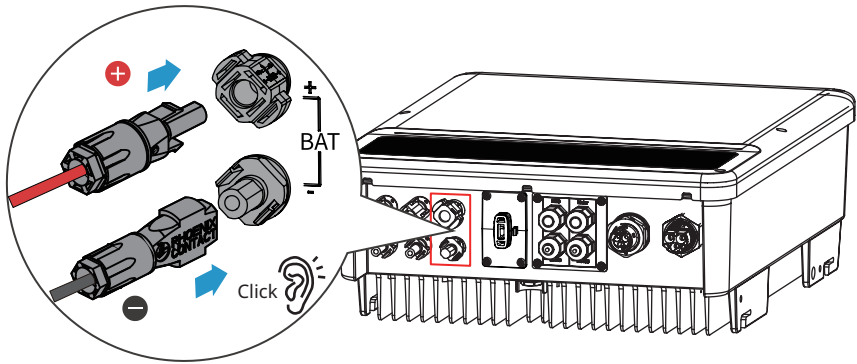

## Phoenix

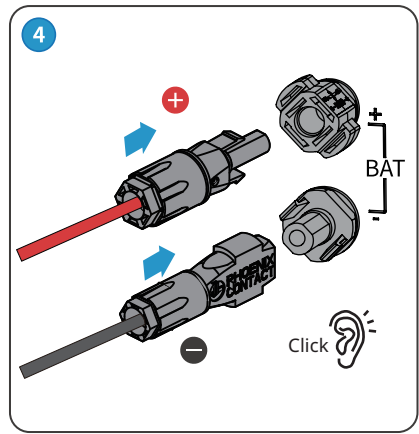
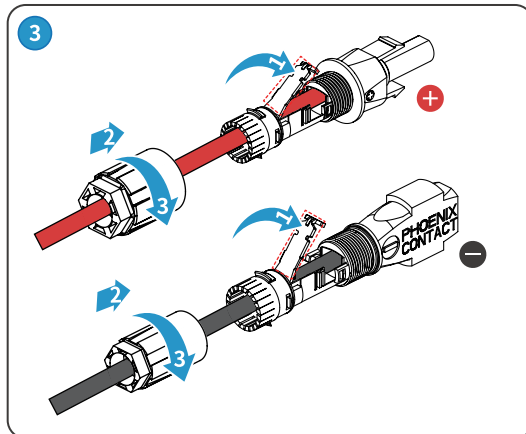
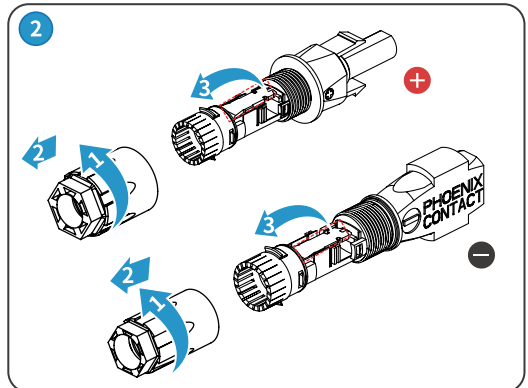
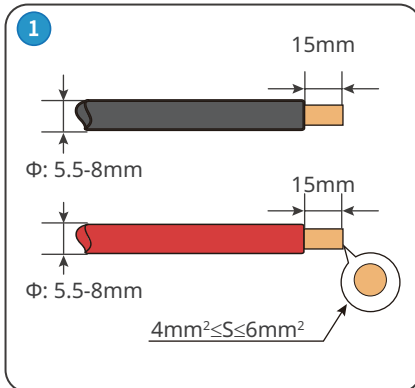

## Vaconn

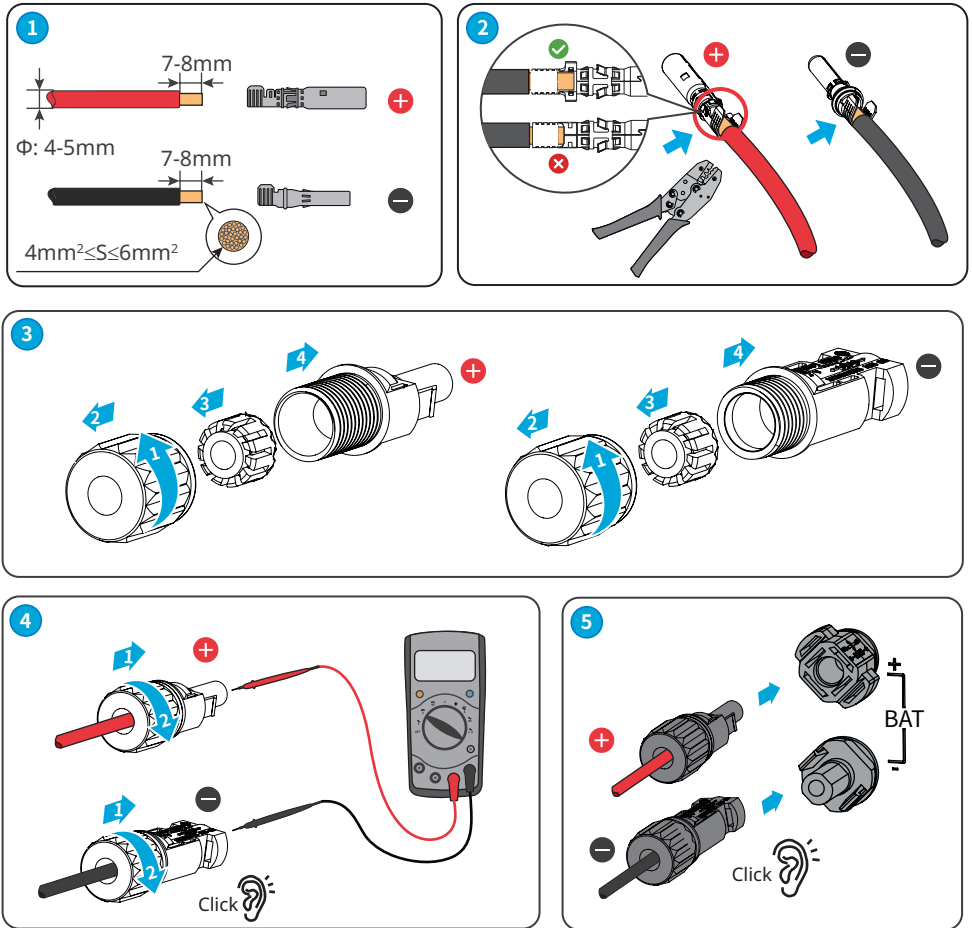

## 6.6 Connecting the AC Cable

### NOTICE

- Install one AC circuit breaker for each inverter. Multiple inverters cannot share one AC circuit breaker. Do not connect loads between the inverter and the AC switch directly connected to the inverter.
- An AC circuit breaker shall be installed on the AC side to make sure that the inverter can safely disconnect the grid when an exception happens. Select an appropriate AC circuit breaker in compliance with local laws and regulations.
- For AC cable, the PE conductor shall be longer than N&L conductors, so that once the AC cable slips or taken out, the protecting earth conductor will be the last to take the strain.



### WARNING

- Connect the AC cables to the corresponding terminals such as “L”, “N”, and PE correctly. Otherwise it will cause damage to the inverter.
- Ensure that the whole cable cores are inserted into the terminal holes. No part of the cable core can be exposed.
- Ensure that the cables are connected securely. Otherwise it will cause damage to the inverter due to overheat during its operation.



### WARNING

- Do not connect any AC generator to the ON-GRID or BACK-UP port.
- The Residual Current Monitoring Unit (RCMU) is integrated into the inverter. The inverter will disconnect the utility grid rapidly once it detects any leak current over the permissible range.
- There are integrated relays inside of the inverter’s ON-GRID and BACK-UP AC ports. When the inverter is in the off-grid mode, the ON-GRID relay is disconnected; while when the inverter is in grid-tied mode, it is connected.
- When the inverter is powered on, the BACK-UP AC port is live. Power off the inverter first if maintenance is required for the loads connected with BACK-UP ports. Otherwise, it may cause electric shock.
- Connect a Residual Current Device (RCD for short) based on local laws and regulations. A type A RCD can be connected to the inverter for protection when DC component of the leakage exceeds the limit. Recommended RCD specifications:  $\geq 30\text{mA}$ .



### 6.6.1 Connecting the AC Cable (ON-GRID)

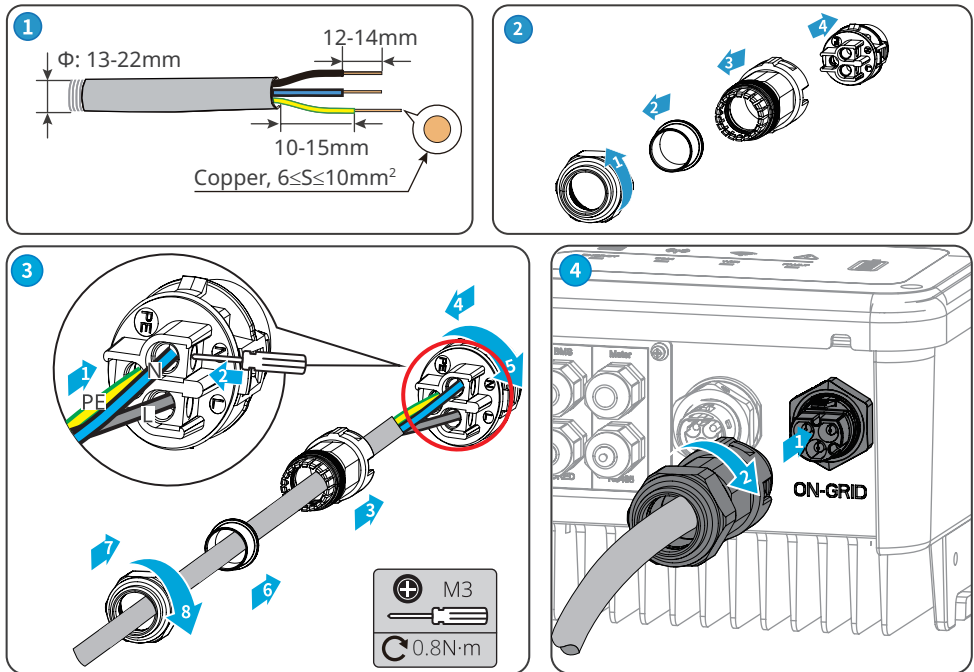
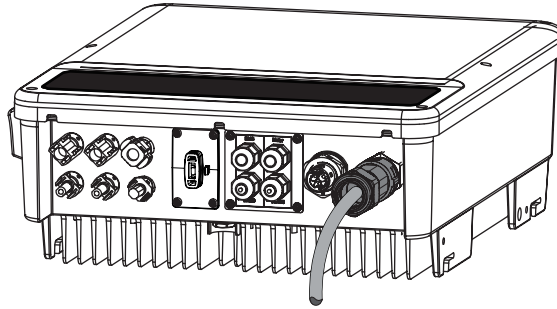

### 6.6.2 Connecting the AC Cable (BACK-UP)

#### NOTICE

- Ensure that the BACK-UP PE cable is connected properly and securely. Otherwise, the BACK-UP function may not work when the grid fails.
- Do not connect the utility grid or any other inverter to the BACK-UP port of the inverter.
- A double-pole three-throw switch (DP3T for short) is recommended to be added on the BACK-UP side for convenient maintenance.

 **WARNING**

- The absence of an AC breaker on the BACK-Up side may lead to inverter damage once an electrical short-circuit happens. And the BACK-UP function cannot be turned off when the inverter is on grid.
- Recommended specification of the circuit breaker: 32A/230V.

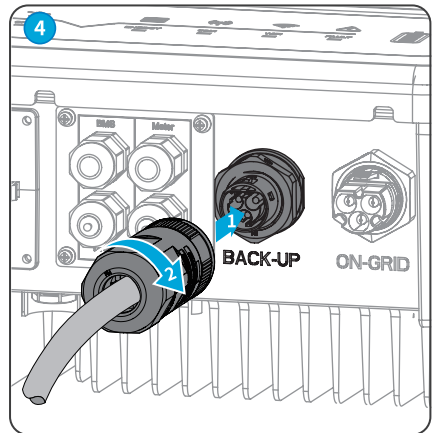
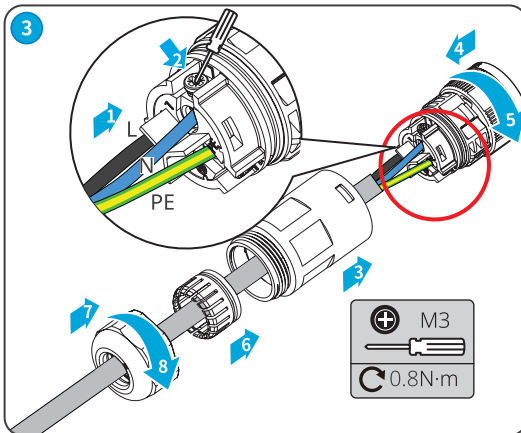
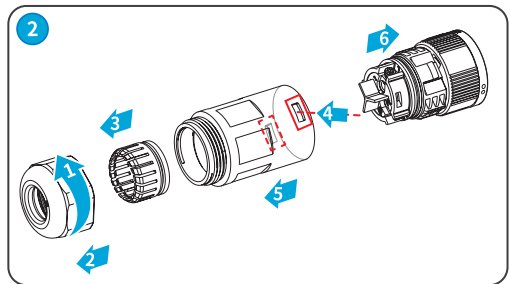
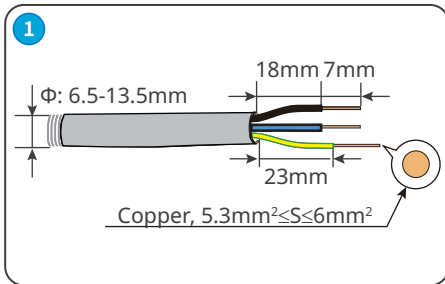
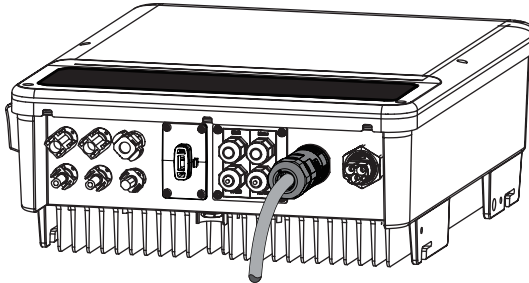

## 6.7 Communication Connection

### 6.7.1 Connecting the Communication Cable

#### NOTICE

- Make sure that the communication device is connected to the right COM port. Route the communication cable far away from any interference source or power cable to prevent the signal from being influenced.
- DRED is only for Australia and New Zealand. Connect the DRED cable using a 6PIN communication terminal. The communication cable and third-party DRED device should be prepared by customers.
- Connect the remote shutdown cable using a 2PIN communication terminal. The communication cable should be prepared by customers.
- Remove the resistor and keep it properly for later use.

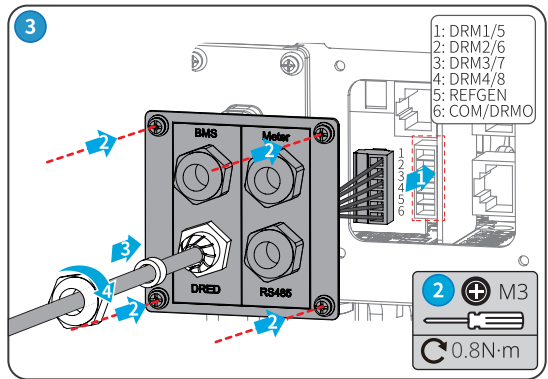
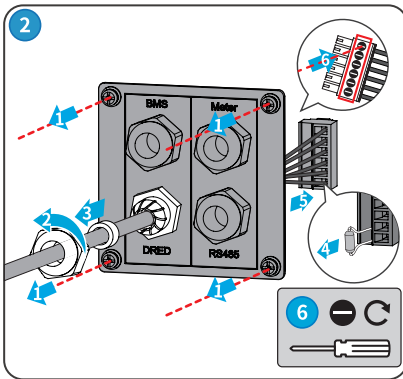
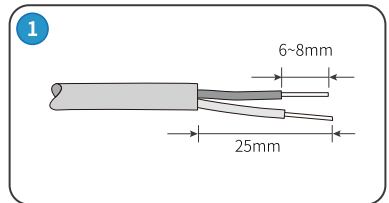
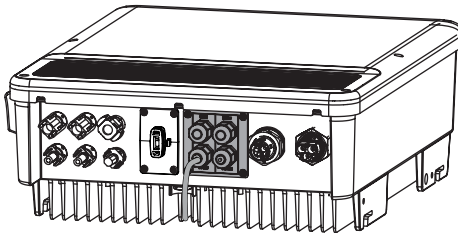



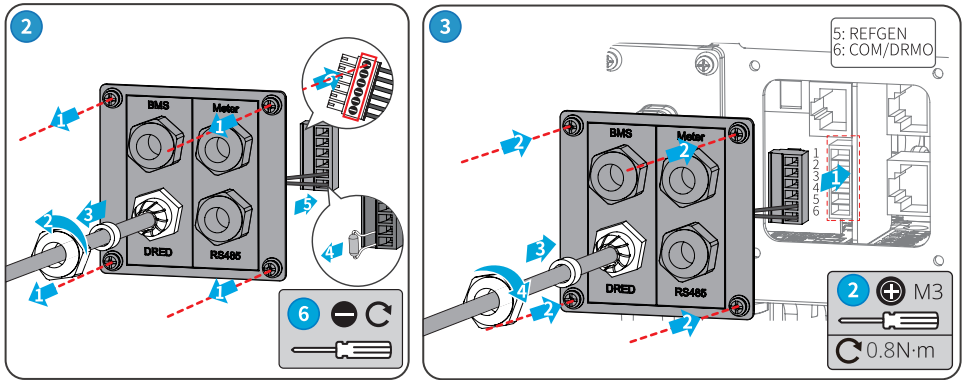

### 6.7.2 Connecting BMS or Meter Communication Cable (Optional)

#### NOTICE

- The smart meter and CT have been preset parameters before delivered with the inverter. Do not modify the relevant parameters.
- The BMS communication cable and communication cable between the inverter and the smart meter is included. For Battery-Ready inverters, the communication cable is not included and should be prepared by customers.
- One smart meter can be connected to one inverter. Do not connect one smart meter to multiple inverters. Contact the manufacturer or dealer to purchase additional smart meter(s) if you need.
- Ensure that CT connects with the corresponding phase line: CT1 is connected to L1; CT2 is connected to L2; and CT3 is connected to L3. And ensure that the CT is connected in the right direction. Please refer to the smart meter user manual for detailed operations.
- RJ45 connector with the following definition can be connected for BMS and meter communication:

No.	Color	BMS	Smart meter	RS485
1	Orange&White	485_A2	NC	485_A
2	Orange	NC	NC	485_B
3	Green&White	485_B2	485_B1	485_A
4	Blue	CAN_H	NC	NC
5	Blue&White	CAN_L	NC	NC
6	Green	NC	485_A1	485_B
7	Brown&White	NC	485_B1	NC
8	Brown	NC	485_A1	NC

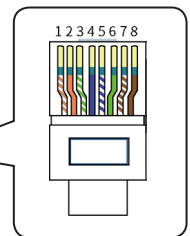

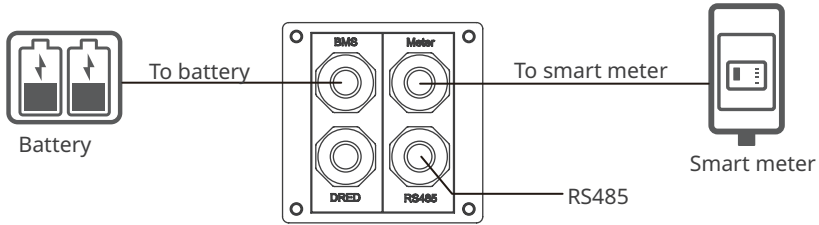

**NOTICE**

Power limit can be realized when the inverter is installed with a smart meter. The specific networkings are as follows.

**Single phase scenario**

When single phase loads are connected, the power limit can be realized by connecting EH or EH Plus series inverters with GM1000.

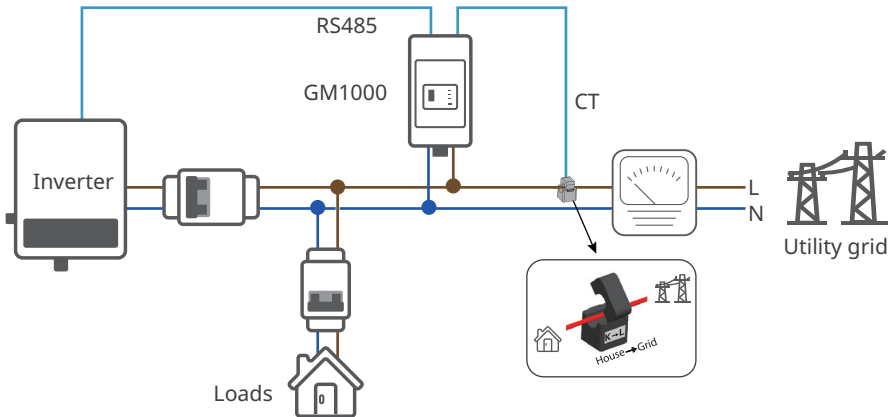

## Split phase scenario

When split phase loads are connected, the power limit can be realized by connecting EH or EH Plus series inverters with GM3000.

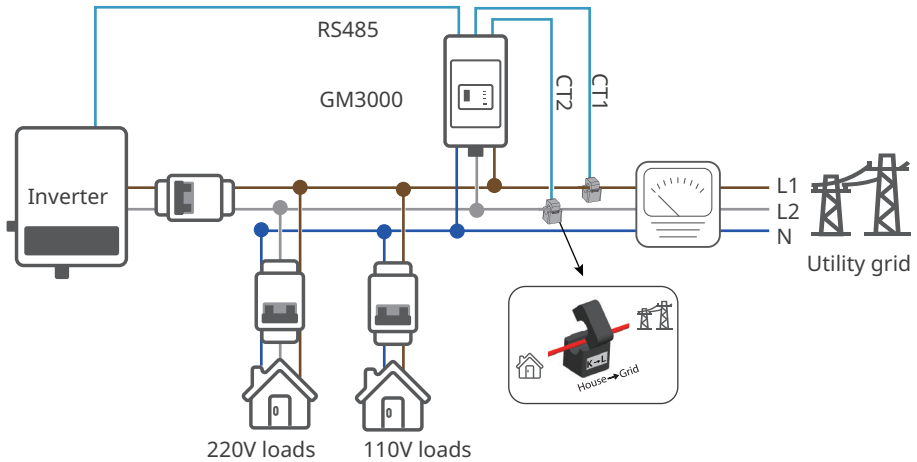

### 6.7.3 Installing the Communication Module (Optional)

Plug a WiFi Kit or Wi-Fi/LAN Kit module into the inverter to establish a connection between the inverter and the smartphone or web pages, which allows set inverter parameters, check running information and fault information, and observe system status in time.

#### NOTICE

Refer to the delivered communication module user manual to get more introduction to the module. For more detailed information, visit [www.goodwe.com](http://www.goodwe.com).

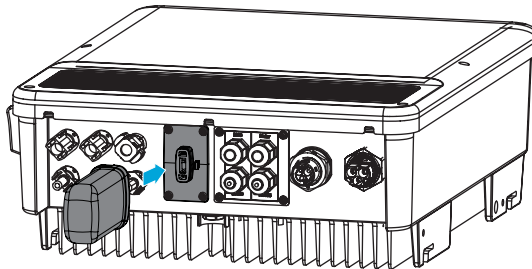

#### WiFi Reset or Reload

Short press the reset button. The WiFi indicator will blink until the WiFi module is reset. Long press the reset button more than 3s. The WiFi indicator will double blink until the WiFi is configured again.

Reset or Reload the WiFi module when:

1. Cannot connect to PV Master app
2. Cannot find "Solar-WiFi signal"
3. WiFi connection failure etc.



## 7 Equipment Commissioning

### 7.1 Check Before Power ON

No.	Check Item
1	The product is firmly installed at a clean place that is well-ventilated and easy-to operate.
2	The PE, DC input, AC output, and communication cables are connected correctly and securely.
3	Cable ties are intact, routed properly and evenly.
4	Unused cable holes are fitted using the waterproof nuts.
5	The voltage and frequency at the connection point meet the inverter grid connection requirements.

### 7.2 Power On

**Step 1:** Turn on the AC breaker on the ON-GRID side of the inverter.





























**Step 2:** Turn on the AC breaker on the BACK-UP side of the inverter.

**Step 3:** Turn on the battery breaker between the inverter and the battery.

**Step 4:** Turn on the DC switch of the inverter.

## 8 System Commissioning

### 8.1 Indicators and Buttons

Indicators	Status	Description
SYSTEM		ON = The system is ready.
		BLINK = The system is starting.
		OFF =The system is not working.
BACK-UP		ON = Back-up is ready / power available.
		OFF = Back-up is off / power not available.
BATTERY		ON = The battery is charging.
		BLINK 1 = The battery is discharging.
		BLINK 2 = The battery is low / soc is low.
		OFF = The battery is disconnected / not active.
GRID		ON = The grid is active and connected.
		BLINK = The grid is active but not connected.
		OFF = The grid is not active.
ENERGY		ON = Consuming energy from grid / buying.
		BLINK 1 = Supplying energy to grid / zeroing.
		BLINK 2 = Supplying energy to grid / selling.
		OFF = The grid is not connected or the system is not working.
COM		ON = Both BMS communication and meter communication are ok.
		BLINK 1 = BMS communication fails; meter communication is ok.
		BLINK 2 = BMS communication is ok; meter communication fails.
		OFF = BMS communicationand meter communication fail.
WiFi		ON = WiFi connected / active.
		BLINK 1 = WiFi is resetting.
		BLINK 2 = WiFi is not connected to the router.
		BLINK 4 = WiFi server problem.
		OFF = WiFi is not active.
FAULT		ON = A fault has occurred.
		BLINK 1 = Back-up output overload / reduce load.
		OFF = No fault.

## 8.2 Setting Inverter Parameters via PV Master App

### NOTICE

Please set the inverter parameters first via PV Master app to ensure its normal operation.

PV Master App is one smart phone application used to communicate with the inverter via bluetooth, WiFi, 4G or GPRS modules. Commonly used functions:

1. Check the operating data, software version, alarms, etc.
2. Set grid parameters, communication parameters, safety countries, power limitation, etc.
3. Equipment maintenance.
4. Upgrade software version.

For more details, refer to PV Master User Manual. Scan the QR code or visit GoodWe official site to get the user manual.

[https://en.goodwe.com/Ftp/EN/Downloads/User%20Manual/GW\\_PV%20Master\\_User%20Manual-EN.pdf](https://en.goodwe.com/Ftp/EN/Downloads/User%20Manual/GW_PV%20Master_User%20Manual-EN.pdf)



PV Master App



PV Master User Manual

### NOTICE

For Australian customers please select from Australia Region A/B/C to comply with AS/NZS 4777.2:2020. Contact local grid operator to see which Region to select. After setting the safety region, some parameters in the inverter system will take effect according to the corresponding safety regulations, such as PU curve, QU curve, trip protection, etc. For Australian and European users, if you need to change the configuration parameters, please refer to the PV Master user manual.

## 8.3 Monitoring via SEMS Portal

SEMS Portal is a monitoring platform used to communicate with the inverter via WiFi, LAN, 4G, or GPRS. Commonly used functions:

1. Manage the organization or User information;
2. Add and monitor the power plant information;
3. Equipment maintenance.



## 9 Maintenance

### 9.1 Power OFF the Inverter

#### DANGER

- Power off the inverter before operations and maintenance. Otherwise, the inverter may be damaged or electric shocks may occur.
- Delayed discharge. Wait until the components are discharged after power off.

**Step 1:** Turn off the AC breaker on the ON-GRID side of the inverter.

**Step 2:** Turn off the AC breaker on the BACK-UP side of the inverter.

**Step 3:** Turn off the battery breaker between the inverter and the battery.

**Step 4:** Turn off the DC switch of the inverter.

### 9.2 Removing the Inverter

#### WARNING

- Make sure that the inverter is powered off.
- Wear proper PPE before any operations.

**Step 1:** Disconnect all the cables, including DC cables, AC cables, communication cables, the communication module, and PE cables.

**Step 2:** Remove the inverter from the mounting plate.

**Step 3:** Remove the mounting plate.

**Step 4:** Store the inverter properly. If the inverter needs to be used later, ensure that the storage conditions meet the requirements.

### 9.3 Disposing of the Inverter

If the inverter cannot work anymore, dispose of it according to the local disposal requirements for electrical equipment waste. The inverter cannot be disposed of together with household waste.

## 9.4 Troubleshooting

Perform troubleshooting according to the following methods. Contact the after-sales service if these methods do not work.

Collect the information below before contacting the after-sales service, so that the problems can be solved quickly.

1. Inverter information like serial number, software version, installation date, fault time, fault frequency, etc.
2. Installation environment, including weather conditions, whether the PV modules are sheltered or shadowed, etc. It is recommended to provide some photos and videos to assist in analyzing the problem.
3. Utility grid situation.

No.	Fault	Cause	Solutions
1	Utility Loss	1. Utility grid power fails. 2. The AC cable is disconnected, or the AC breaker is off.	1. The alarm is automatically cleared after the grid power supply is restored. 2. Check whether the AC cable is connected and the AC breaker is on.
2	Grid Overvoltage	The grid voltage exceeds the permissible range, or the duration of high voltage exceeds the requirement of HVRT.	1. If the problem occurs occasionally, the utility grid may be abnormal temporarily. The inverter will recover automatically after detecting that the utility grid is normal. 2. If the problem occurs frequently, check whether the grid voltage is within the permissible range. <ul style="list-style-type: none"> <li>• Contact the local power company if the grid voltage exceeds the permissible range.</li> <li>• Modify the overvoltage protection threshold, HVRT or disable the overvoltage protection function after obtaining the consent of the local power company if the grid frequency is within the permissible range.</li> </ul> 3. Check whether the AC breaker and the output cables are connected securely and correctly if the problem persists.



No.	Fault	Cause	Solutions
3	Grid Rapid Overvoltage	The grid voltage is abnormal or ultra-high.	<ol style="list-style-type: none"> <li>1. If the problem occurs occasionally, the utility grid may be abnormal temporarily. The inverter will recover automatically after detecting that the utility grid is normal.</li> <li>2. If the problem occurs frequently, check whether the grid voltage is within the permissible range. <ul style="list-style-type: none"> <li>• Contact the local power company if the grid voltage exceeds the permissible range.</li> <li>• Modify the grid overvoltage rapid protection threshold after obtaining the consent of the local power company if the grid voltage is within the permissible range.</li> </ul> </li> </ol>
4	Grid Undervoltage	The grid voltage is lower than the permissible range, or the duration of low voltage exceeds the requirement of LVRT.	<ol style="list-style-type: none"> <li>1. If the problem occurs occasionally, the utility grid may be abnormal temporarily. The inverter will recover automatically after detecting that the utility grid is normal.</li> <li>2. If the problem occurs frequently, check whether the grid voltage is within the permissible range. <ul style="list-style-type: none"> <li>• Contact the local power company if the grid voltage exceeds the permissible range.</li> <li>• Modify the undervoltage protection threshold, LVRT or disable the undervoltage protection function after obtaining the consent of the local power company if the grid frequency is within the permissible range.</li> </ul> </li> <li>3. Check whether the AC breaker and the output cables are connected securely and correctly if the problem persists.</li> </ol>
5	Grid 10min Overvoltage	The moving average of grid voltage in 10min exceeds the range of safety requirements.	<ol style="list-style-type: none"> <li>1. If the problem occurs occasionally, the utility grid may be abnormal temporarily. The inverter will recover automatically after detecting that the utility grid is normal.</li> <li>2. If the problem occurs frequently, check whether the grid voltage is within the permissible range. <ul style="list-style-type: none"> <li>• Contact the local power company if the grid voltage exceeds the permissible range.</li> <li>• Modify the grid overvoltage rapid protection threshold after obtaining the consent of the local power company if the grid voltage is within the permissible range.</li> </ul> </li> </ol>



No.	Fault	Cause	Solutions
6	Grid Overfrequency	Utility grid exception. The actual grid frequency exceeds the requirement of the local grid standard.	<ol style="list-style-type: none"> <li>1. If the problem occurs occasionally, the utility grid may be abnormal temporarily. The inverter will recover automatically after detecting that the utility grid is normal.</li> <li>2. If the problem occurs frequently, check whether the grid frequency is within the permissible range.                             <ul style="list-style-type: none"> <li>• Contact the local power company if the grid frequency exceeds the permissible range.</li> <li>• Modify the overfrequency protection threshold or disable the overfrequency protection function after obtaining the consent of the local power company if the grid frequency is within the permissible range.</li> </ul> </li> </ol>
7	Anti-islanding	The utility grid is disconnected. The utility grid is disconnected according to the safety regulations, but the grid voltage is maintained due to the loads.	<ol style="list-style-type: none"> <li>1. Check whether the utility grid is disconnected.</li> <li>2. Contact the dealer or the after-sales service.</li> </ol>
8	Grid Underfrequency	Utility grid exception. The actual grid frequency is lower than the requirement of the local grid standard.	<ol style="list-style-type: none"> <li>1. If the problem occurs occasionally, the utility grid may be abnormal temporarily. The inverter will recover automatically after detecting that the utility grid is normal.</li> <li>2. If the problem occurs frequently, check whether the grid frequency is within the permissible range.                             <ul style="list-style-type: none"> <li>• Contact the local power company if the grid frequency exceeds the permissible range.</li> <li>• Modify the underfrequency protection threshold or disable the underfrequency protection function after obtaining the consent of the local power company if the grid frequency is within the permissible range.</li> </ul> </li> </ol>

No.	Fault	Cause	Solutions
9	Grid Frequency Instability	Utility grid exception. The actual grid frequency change rate does not meet the requirement of the local grid standard.	<ol style="list-style-type: none"> <li>If the problem occurs occasionally, the utility grid may be abnormal temporarily. The inverter will recover automatically after detecting that the utility grid is normal.</li> <li>If the problem occurs frequently, check whether the grid frequency is within the permissible range. <ul style="list-style-type: none"> <li>Contact the local power company if the grid frequency exceeds the permissible range.</li> <li>Contact the dealer or the after-sales service if the grid frequency is within the permissible range.</li> </ul> </li> </ol>
10	LVRT Undervoltage	Utility grid exception. The duration of the utility grid exception exceeds the set time of LVRT.	<ol style="list-style-type: none"> <li>If the problem occurs occasionally, the utility grid may be abnormal temporarily. The inverter will recover automatically after detecting that the utility grid is normal.</li> <li>If the problem occurs frequently, check whether the grid frequency is within the permissible range. If not, contact the local power company. If yes, contact the dealer or the after-sales service.</li> </ol>
11	HVRT Overvoltage	Utility grid exception. The duration of utility grid exception exceeds the set time of HVRT.	
12	Abnormal GFCI 30mA	The input insulation impedance becomes low when the inverter is working.	
13	Abnormal GFCI 60mA		
14	Abnormal GFCI 150mA		
15	Abnormal GFCI		
16	Large DC of AC current L1	The DC component of the output current exceeds the safety range or default range.	<ol style="list-style-type: none"> <li>If the problem is caused by an external fault like a utility grid exception or frequency exception, the inverter will recover automatically after solving the problem.</li> <li>If the problem occurs frequently and the PV station cannot work properly, contact the dealer or the after-sales service.</li> </ol>
17	Large DC of AC current L2		

No.	Fault	Cause	Solutions
18	Low Insulation Res.	<ol style="list-style-type: none"> <li>1. The PV string is short-circuited to PE.</li> <li>2. The PV system is in a moist environment and the cable is not well insulated to the ground.</li> </ol>	<ol style="list-style-type: none"> <li>1. Check whether the resistance of the PV string to PE exceeds 50kΩ. If no, check the short circuit point.</li> <li>2. Check whether the PE cable is connected correctly.</li> <li>3. If the resistance is lower on rainy days, please reset the ISO.</li> </ol>
19	Abnormal Ground	<ol style="list-style-type: none"> <li>1. The PE cable of the inverter is not connected well.</li> <li>2. The L cable and N cable are connected reversely when output of the PV string is grounded.</li> </ol>	<ol style="list-style-type: none"> <li>1. Check whether the PE cable of the inverter is connected properly.</li> <li>2. Check whether the L cable and N cable are connected reversely if output of the PV string is grounded.</li> </ol>
20	Anti Reverse power Failure	Abnormal fluctuation of load	<ol style="list-style-type: none"> <li>1. If the exception is caused by an external fault, the inverter will recover automatically after solving the problem.</li> <li>2. If the problem occurs frequently and the PV station cannot work properly, contact the dealer or the after-sales service.</li> </ol>
21	Internal Comm Loss	<ol style="list-style-type: none"> <li>1. Frame format error</li> <li>2. Parity checking error</li> <li>3. Can bus offline</li> <li>4. Hardware CRC error</li> <li>5. Send (receive) control bit is receive (send).</li> <li>6. Transmit to the unit that is not allowed.</li> </ol>	<p>Disconnect the AC output switch and DC input switch, then connect them 5 minutes later. Contact the dealer or the after-sales service if the problem persists.</p>
22	AC HCT Check abnormal	The sampling of the AC HCT is abnormal.	<p>Disconnect the AC output switch and DC input switch, then connect them 5 minutes later. Contact the dealer or the after-sales service if the problem persists.</p>

No.	Fault	Cause	Solutions
23	GFCI HCT Check abnormal	The sampling of the GFCI HCT is abnormal.	Disconnect the AC output switch and DC input switch, then connect them 5 minutes later. Contact the dealer or the after-sales service if the problem persists.
24	Relay Check abnormal	<ol style="list-style-type: none"> <li>1. The relay is abnormal or short-circuited.</li> <li>2. The control circuit is abnormal.</li> <li>3. The AC cable connection is abnormal, like a virtual connection or short circuit.</li> </ol>	Disconnect the AC output switch and DC input switch, then connect them 5 minutes later. Contact the dealer or the after-sales service if the problem persists.
26	Flash Fault	The internal Flash storage is abnormal.	Disconnect the AC output switch and DC input switch, then connect them 5 minutes later. Contact the dealer or the after-sales service if the problem persists.
27	DC Arc Fault	<ol style="list-style-type: none"> <li>1. The DC terminal is not firmly connected.</li> <li>2. The DC cable is broken.</li> </ol>	Read the Quick Installation Guide and check whether the cables are connected properly.
28	AFCI Self-test Fault	AFCI detection is abnormal.	Disconnect the AC output switch and DC input switch, then connect them 5 minutes later. Contact the dealer or the after-sales service if the problem persists.
29	Cavity Overtemperature	<ol style="list-style-type: none"> <li>1. The inverter is installed in a place with poor ventilation.</li> <li>2. The ambient temperature exceeds 60°C.</li> <li>3. A fault occurs in the internal fan of the inverter.</li> </ol>	<ol style="list-style-type: none"> <li>1. Check the ventilation and the ambient temperature at the installation point.</li> <li>2. If the ventilation is poor or the ambient temperature is too high, improve the ventilation and heat dissipation.</li> <li>3. Contact the dealer or after-sales service if both the ventilation and the ambient temperature are normal.</li> </ol>
30	BUS Overvoltage	<ol style="list-style-type: none"> <li>1. The PV voltage is too high.</li> <li>2. The sampling of the inverter BUS voltage is abnormal.</li> </ol>	Disconnect the AC output switch and DC input switch, then connect them 5 minutes later. Contact the dealer or the after-sales service if the problem persists.



No.	Fault	Cause	Solutions
31	PV Input Overvoltage	The PV array configuration is not correct. Too many PV panels are connected in series in the PV string.	Check the serial connection of the PV array. Make sure that the open circuit voltage of the PV string is not higher than the maximum operating voltage of the inverter.
32	PV Continuous Hardware Overcurrent	<ol style="list-style-type: none"> <li>1. The PV configuration is not proper.</li> <li>2. The hardware is damaged.</li> </ol>	Disconnect the AC output switch and DC input switch, then connect them 5 minutes later. Contact the dealer or the after-sales service if the problem persists.
33	PV Continuous Software Overcurrent	<ol style="list-style-type: none"> <li>1. The PV configuration is not proper.</li> <li>2. The hardware is damaged.</li> </ol>	Disconnect the AC output switch and DC input switch, then connect them 5 minutes later. Contact the dealer or the after-sales service if the problem persists.
34	String1 PV String Reversed	The PV string is connected reversely.	Check whether the PV strings are connected reversely.
35	String2 PV String Reversed		

## 9.5 Routine Maintenance

### WARNING

- Make sure that the inverter is powered off.
- Wear proper PPE before any operations.

Maintaining Item	Maintaining Method	Maintaining Period
System Clean	Check the heat sink, air intake, and air outlet for foreign matter or dust.	Once 6-12 months
DC Switch	Turn the DC switch on and off ten consecutive times to make sure that it is working properly.	Once a year
Electrical Connection	Check whether the cables are securely connected. Check whether the cables are broken or whether there is any exposed copper core.	Once 6-12 months
Sealing	Check whether all the terminals and ports are properly sealed. Reseal the cable hole if it is not sealed or too big.	Once a year
THDi Test	For Australia requirements, in the THDi test, there should add Zref between inverter and mains. L: $0.24 \Omega + j0.15 \Omega$ ; N: $0.16 \Omega + j0.10 \Omega$ L: $0.15 \Omega + j0.15 \Omega$ ; N: $0.1 \Omega + j0.1 \Omega$	As needed.

## 10 Technical Parameters

Technical Data	GW3600-EH	GW5000-EH	GW6000-EH
<b>Battery Input Data</b>			
Battery Type	Li-Ion	Li-Ion	Li-Ion
Nominal Battery Voltage (V)	350	350	350
Battery Voltage Range (V)	85~460	85~460	85~460
Max. Continuous Charging Current (A)	25	25	25
Max. Continuous Discharging Current (A)	25	25	25
Max. Charge Power (W)	3,600	5,000	6,000
Max. Discharge Power (W)	3,600	5,000	6,000
<b>PV String Input Data</b>			
Max. Input Power (W)	4,800	6,650	8,000
Max. Input Voltage (V)	580	580	580
MPPT Operating Voltage Range (V)	100~550	100~550	100~550
MPPT Voltage Range at Nominal Power (V)	150~550	210~550	250~550
Start-up Voltage (V)	90	90	90
Nominal Input Voltage (V)	380	380	380
Max. Input Current per MPPT (A)	12.5	12.5	12.5
Max. Short Circuit Current per MPPT (A)	15.2	15.2	15.2
Max. Backfeed Current to The Array (A)	0	0	0
Number of MPP Trackers	2	2	2
Number of Strings per MPPT	1	1	1
<b>AC Output Data (On-grid)</b>			
Nominal Apparent Power Output to Utility Grid (VA)*1	3,600	5,000	6,000
Max. Apparent Power Output to Utility Grid (VA)*1	3600	5000	6000



Technical Data	GW3600-EH	GW5000-EH	GW6000-EH
Nominal Apparent Power from Utility Grid (VA)	7,200	10,000	12,000
Max. Apparent Power from Utility Grid (VA)	7200(Charging 3.6kw, Backup Output 3.6kw)	10000(Charging 5kw, Backup Output 5kw)	12,000 (Charging 6kW, Backup Output 6kW)
Nominal Output Voltage (V)	230/220*5	230/220*5	230/220*5
Output Voltage Range (V)	0~300	0~300	0~300
Nominal AC Grid Frequency (Hz)	50/60	50/60	50/60
AC Grid Frequency Range (Hz)	45~65	45~65	45~65
Max. AC Current Output to Utility Grid (A)	16	21.7	26.1/27.3*6
Max. AC Current From Utility Grid (A)	32.0	43.4	52.2
Max. Output Fault Current (Peak and Duration) (A)	65@5μs	65@5μs	65@5μs
Inrush Current (Peak and Duration) (A)	65@5μs	65@5μs	65@5μs
Nominal Output Current (A)	15.6	21.7	26.1
Power Factor	~1(Adjustable from 0.8 leading to 0.8 lagging)		
Max. Total Harmonic Distortion	<3%		
Maximum Output Overcurrent Protection (A)	40	54	65
<b>AC Output Data (Back-up)</b>			
Back-up Nominal Apparent Power (VA)	3,600	5,000	6,000
Max. Output Apparent Power (VA)	3,600 (4,320@60sec)	5,000 (6,000@60sec)	6,000 (7,200@60sec)
Nominal Output Current (A)	15.7	21.7	26.1
Max. Output Current (A)	15.7	21.7	26.1
Max. Output Fault Current (Peak and Duration) (A)	19@60s	26@60s	31@60s
Inrush Current (Peak and Duration) (A)	65@5μs	65@5μs	65@5μs
Maximum Output Overcurrent Protection (A)	16	21.7	26.1

Technical Data	GW3600-EH	GW5000-EH	GW6000-EH
Nominal Output Voltage (V)	230 (±2%)	230 (±2%)	230 (±2%)
Nominal Output Frequency (Hz)	50/60 (±0.2%)	50/60 (±0.2%)	50/60 (±0.2%)
Output THDv (@Linear Load)	<3%	<3%	<3%
<b>Efficiency</b>			
Max. Efficiency	97.6%		
European Efficiency	97.0%		
Max. Battery to AC Efficiency	96.6%		
MPPT Efficiency	99.9%		
<b>Protection</b>			
PV Insulation Resistance Detection	Integrated		
Residual Current Monitoring	Integrated		
Battery Reverse Polarity Protection	Integrated		
Anti-islanding Protection	Integrated		
AC Overcurrent Protection	Integrated		
AC Short Circuit Protection	Integrated		
AC Overvoltage Protection	Integrated		
<b>General Data</b>			
Operating Temperature Range (°C)	-25~+60		
Relative Humidity	0~95%		
Max. Operating Altitude (m)	3000*8		
Cooling Method	Natural Convection		
User Interface	LED, APP		
Communication with BMS*2	RS485, CAN		
Communication with Meter	RS485		
Communication with Portal	WiFi / Ethernet (Optional)		
Weight (kg)	17		
Dimension (W×H×D mm)	354×433×147		
Noise Emission (dB)	<35		
Topology	Non-isolated		
Self-consumption at Night (W)*3	<10		

Technical Data	GW3600-EH	GW5000-EH	GW6000-EH
Ingress Protection Rating	IP65		
DC Connector	MC4 (4~6 mm <sup>2</sup> )		
AC Connector	Quick Plug		
Environmental Category	4K4H		
Pollution Degree	III		
Overtoltage Category	DC II / AC III		
Protective Class	I		
Storage Temperature (°C)	-40~+85		
The Decisive Voltage Class (DVC)	Battery: C PV: C AC: C Com: A		
Mounting Method	Wall Mounted		
Active Anti-islanding Method	AFDPF + AQDPF <sup>*7</sup>		
Type of Electrical Supply System	Single phase TN/TT system		
Country of Manufacture	China		
Certifications <sup>*4</sup>			
Grid Standards	VDE-AR-N 4105, G98, G100, CEI 0-21, AS/NZS4777.2, NRS097-2-1		
Safety Regulation	IEC/EN 62109-1&2		
EMC	EN61000-6-1, EN61000-6-2, EN61000-6-3, EN61000-6-4, EN 61000-4-16, EN 61000-4-18, EN 61000-4-29		
<p>*1: The grid feed in power for VDE-AR-N 4105 and NRS097-2-1 is limited 4600VA.</p> <p>*2: CAN communication is configured by default. If 485 communication is used, please replace the corresponding communication line.</p> <p>*3: No Back-up Output.</p> <p>*4: Not all certifications &amp; standards listed, check the official website for details.</p> <p>*5: For Brazil, the voltage is 220V.</p> <p>*6: For Brazil, the current is 27.3A.</p> <p>*7: AFDPF: Active Frequency Drift with Positive Feedback, AQDPF: Active Q Drift with Positive Feedback.</p> <p>*8: 2000m for Australia.</p>			



Technical Data	GW3600N-EH	GW5000N-EH	GW6000N-EH
<b>Battery Input Data</b>			
Battery Type	Li-Ion	Li-Ion	Li-Ion
Nominal Battery Voltage (V)	350	350	350
Battery Voltage Range (V)	85~460	85~460	85~460
Start-up Voltage (V)	85	85	85
Number of Battery Input	1	1	1
Max. Continuous Charging Current (A)	25	25	25
Max. Continuous Discharging Current (A)	25	25	25
Max. Charge Power (W)	6,000	6,000	6,000
Max. Discharge Power (W)	3,600	5,000	6,000
<b>PV String Input Data</b>			
Max. Input Power (W)	5,400	7,500	9,000
Max. Input Voltage (V)	580	580	580
MPPT Operating Voltage Range (V)	100~550	100~550	100~550
MPPT Voltage Range at Nominal Power (V)	150~550	210~550	250~550
Start-up Voltage (V)	85	85	85
Nominal Input Voltage (V)	380	380	380
Max. Input Current per MPPT (A)	16	16	16
Max. Short Circuit Current per MPPT (A)	21.2	21.2	21.2
Max. Backfeed Current to The Array (A)	0	0	0
Number of MPP Trackers	2	2	2
Number of Strings per MPPT	1	1	1
<b>AC Output Data (On-grid)</b>			
Nominal Output Power (W)	3,600	5,000	6,000
Max. Output Power (W)	3600/3960*1	5000/5500*1	6000/6600*1



Technical Data	GW3600N-EH	GW5000N-EH	GW6000N-EH
Nominal Apparent Power Output to Utility Grid (VA)	3,600	5,000	6,000
Max. Apparent Power Output to Utility Grid (VA)	3600/3960*1	5000/5500*1	6000/6600*1
Nominal Apparent Power from Utility Grid (VA)	7200	10,000	12,000
Max. Apparent Power from Utility Grid (VA)	7200 (Charging 3.6kW, Backup Output 3.6kW)	10,000 (Charging 5kW, Backup Output 5kW)	12,000 (Charging 6kW, Backup Output 6kW)
Nominal Output Voltage (V)	230/220*6	230/220*6	230/220*6
Output Voltage Range (V)	0~300	0~300	0~300
Nominal AC Grid Frequency (Hz)	50/60	50/60	50/60
AC Grid Frequency Range (Hz)	45~65	45~65	45~65
Max. AC Current Output to Utility Grid (A)	16/18*1	21.7/24*1	26.1/28.7*1/27.3*7
Max. AC Current From Utility Grid (A)	32	43.4	52.2
Nominal AC Current From Utility Grid (A)	32	43.4	52.2
Max. Output Fault Current (Peak and Duration) (A)	65A@5μs	65A@5μs	65A@5μs
Inrush Current (Peak and Duration) (A)	65A@5μs	65A@5μs	65A@5μs
Nominal Output Current (A)	15.6	21.7	26.1
Power Factor	~1 (Adjustable from 0.8 leading to 0.8 lagging)	~1 (Adjustable from 0.8 leading to 0.8 lagging)	~1 (Adjustable from 0.8 leading to 0.8 lagging)
Max. Total Harmonic Distortion	<3%	<3%	<3%
Maximum Output Overcurrent Protection (A)	17.2	23.9	28.7
Type of Voltage (a.c. or d.c.)	a.c.	a.c.	a.c.
<b>AC Output Data (Back-up)</b>			
Back-up Nominal Apparent Power (VA)	3600	5000	6,000

Technical Data	GW3600N-EH	GW5000N-EH	GW6000N-EH
Max. Output Apparent Power without Grid(VA)	3600 (4320 @60sec)	5000 (6000@60sec)	6,000 (7,200@60sec)
Max. Output Apparent Power with Grid(VA)	3600	5000	6,000
Nominal Output Current (A)	15.7	21.7	26.1
Max. Output Current (A)	15.7	21.7	26.1
Max. Output Fault Current (Peak and Duration) (A)	65A@5μs	65A@5μs	65A@5μs
Inrush Current (Peak and Duration) (A)	65A@5μs	65A@5μs	65A@5μs
Maximum Output Overcurrent Protection (A)	18.8	26.1	31.3
Nominal Output Voltage (V)	230 (±2%)	230 (±2%)	230 (±2%)
Nominal Output Frequency (Hz)	50/60 (±0.2%)	50/60 (±0.2%)	50/60 (±0.2%)
Output THDv (@Linear Load)	<3%	<3%	<3%
<b>Output THDv (@Linear Load)</b>			
Max. Efficiency	97.6%	97.6%	97.6%
European Efficiency	97.0%	97.0%	97.0%
Max. Battery to AC Efficiency	96.6%	96.6%	96.6%
MPPT Efficiency	99.9%	99.9%	99.9%
<b>Protection</b>			
PV String Current Monitoring	Integrated	Integrated	Integrated
PV Insulation Resistance Detection	Integrated	Integrated	Integrated
Residual Current Monitoring	Integrated	Integrated	Integrated
PV Reverse Polarity Protection	Integrated	Integrated	Integrated
Battery Reverse Polarity Protection	Integrated	Integrated	Integrated
Anti-islanding Protection	Integrated	Integrated	Integrated
AC Overcurrent Protection	Integrated	Integrated	Integrated
AC Short Circuit Protection	Integrated	Integrated	Integrated
AC Overvoltage Protection	Integrated	Integrated	Integrated
DC Switch	Integrated	Integrated	Integrated
DC Surge Protection	Type II	Type II	Type II

Technical Data	GW3600N-EH	GW5000N-EH	GW6000N-EH
AC Surge protection	Type III	Type III	Type III
Remote Shutdown	Integrated	Integrated	Integrated
<b>General Data</b>			
Operating Temperature Range (°C)	-25~+60	-25~+60	-25~+60
Relative Humidity	0~95%	0~95%	0~95%
Max. Operating Altitude (m)	3000*9	3000*9	3000*9
Cooling Method	Natural Convection	Natural Convection	Natural Convection
User Interface	LED, APP	LED, APP	LED, APP
Communication with BMS*3	RS485, CAN	RS485, CAN	RS485, CAN
Communication with Meter	RS485	RS485	RS485
Communication with Portal	WiFi / Ethernet (Optional)	WiFi / Ethernet (Optional)	WiFi / Ethernet (Optional)
Weight (kg)	17	17	17
Dimension (W×H×D mm)	354×433×147	354×433×147	354×433×147
Noise Emission (dB)	<35	<35	<35
Topology	Non-isolated	Non-isolated	Non-isolated
Self-consumption at Night (W)*4	<10	<10	<10
Ingress Protection Rating	IP65	IP65	IP65
DC Connector	MC4 (4~6 mm2)	MC4 (4~6 mm2)	MC4 (4~6 mm2)
AC Connector	Quick Plug	Quick Plug	Quick Plug
Environmental Category	4K4H	4K4H	4K4H
Pollution Degree	III	III	III
Overvoltage Category	DC II / AC III	DC II / AC III	DC II / AC III
Protective Class	I	I	I
Storage Temperature (°C)	-40~+85	-40~+85	-40~+85
The Decisive Voltage Class (DVC)	Battery: C PV: C AC: C Com: A	Battery: C PV: C AC: C Com: A	Battery: C PV: C AC: C Com: A
Mounting Method	Wall Mounted	Wall Mounted	Wall Mounted
Active Anti-islanding Method	AFDPF + AQDPF *8		



Technical Data	GW3600N-EH	GW5000N-EH	GW6000N-EH
Type of Electrical Supply System	Single phase TN/TT system		
Country of Manufacture	China	China	China
<b>Certifications*5</b>			
Grid Standards	VDE-AR-N 4105, G98, G100, CEI 0-21, AS/NZS4777.2, NRS097-2-1		
Safety Regulation	IEC/EN 62109-1&2		
EMC	EN61000-6-1, EN61000-6-2, EN61000-6-3, EN61000-6-4, EN 61000-4-16, EN 61000-4-18, EN 61000-4-29		
<p>*1: For CEI 0-21.</p> <p>*2: The grid feed in power for VDE-AR-N 4105 and NRS097-2-1 is limited 4600VA.</p> <p>*3: CAN communication is configured by default. If 485 communication is used, please replace the corresponding communication line.</p> <p>*4: No Back-up Output.</p> <p>*5: Not all certifications &amp; standards listed, check the official website for details.</p> <p>*6: For Brazil, the voltage is 220V.</p> <p>*7: For Brazil, the current is 27.3A.</p> <p>*8: AFDPF: Active Frequency Drift with Positive Feedback, AQDPF: Active Q Drift with Positive Feedback.</p> <p>*9: 2000m for Australia.</p>			







Official Website

GoodWe Technologies Co.,Ltd.

---

 No. 90 Zijin Rd., New District, Suzhou, 215011, China

 T: 400-998-1212

 [www.goodwe.com](http://www.goodwe.com)

 [service@goodwe.com](mailto:service@goodwe.com)



**Densys pv5**

| We deliver. You install. The sun does all the rest. | Data sheet provided for you @ [www.densys-pv5.de](http://www.densys-pv5.de)



Contact Information